

US00D570745S

(12) **United States Design Patent**  
**Camasmie**

(10) **Patent No.:** **US D570,745 S**

(45) **Date of Patent:** **\*\* Jun. 10, 2008**

(54) **NECK REST FOR A RECUMBENT CYCLE**

(75) Inventor: **Paulo Camasmie**, Windermere, FL  
(US)

(73) Assignee: **Big Cat Human Powered Vehicles, LLC**, Winter Garden, FL (US)

(\*\*) Term: **14 Years**

(21) Appl. No.: **29/249,673**

(22) Filed: **Oct. 17, 2006**

(51) **LOC (8) Cl.** ..... **12-11**

(52) **U.S. Cl.** ..... **D12/114**

(58) **Field of Classification Search** ..... D12/111,  
D12/112, 222, 223, 117, 114; 280/259-261,  
280/282, 263, 266-269, 288.4, 290, 304.4,  
280/288.1-288.3, 281.1, 274-280, 283-288;  
D6/354, 500-502; 297/61, 195.1, 201, 204,  
297/215.1, 215.11-215.15, 391-410  
See application file for complete search history.

(56) **References Cited**

**U.S. PATENT DOCUMENTS**

D290,451 S \* 6/1987 Engum ..... D12/112

D293,660 S \* 1/1988 Foehner ..... D12/111  
5,544,906 A \* 8/1996 Clapper ..... 280/288.1  
D385,829 S \* 11/1997 Quick ..... D12/111  
D507,910 S \* 8/2005 Bock ..... D6/501  
6,932,370 B2 \* 8/2005 Jones et al. .... 280/282

\* cited by examiner

*Primary Examiner*—Cathron Brooks

*Assistant Examiner*—Linda Brooks

(74) *Attorney, Agent, or Firm*—GrayRobinson, PA

(57) **CLAIM**

The ornamental design for a neck rest for a recumbent cycle,  
as shown and described.

**DESCRIPTION**

FIG. 1 is a perspective view of my ornamental design of a  
neck rest for a recumbent cycle;

FIG. 2 is a top, plan view thereof;

FIG. 3 is a bottom, plan view thereof;

FIG. 4 is a side view thereof;

FIG. 5 is a rear view thereof; and,

FIG. 6 is a front view thereof.

**1 Claim, 1 Drawing Sheet**

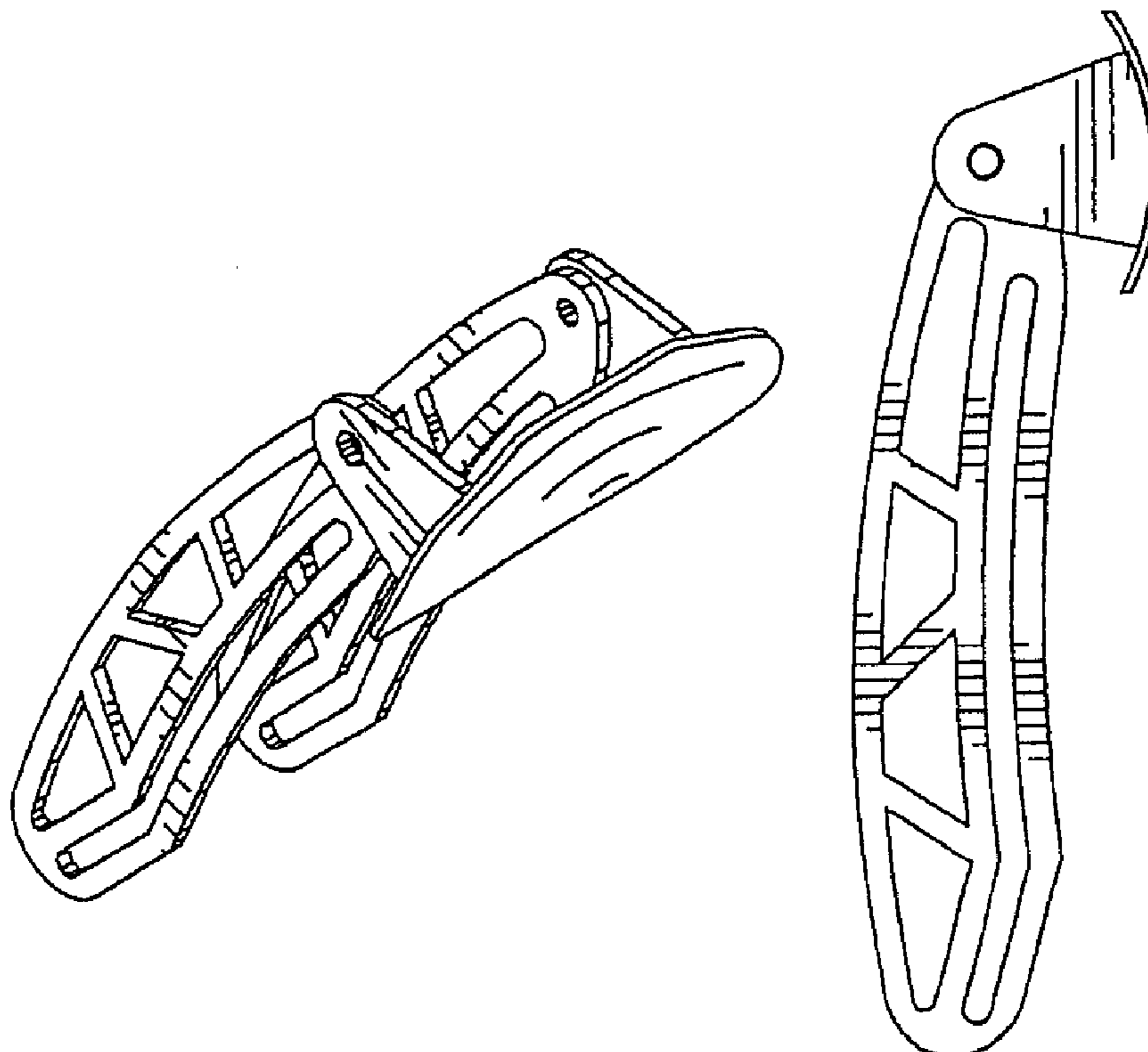

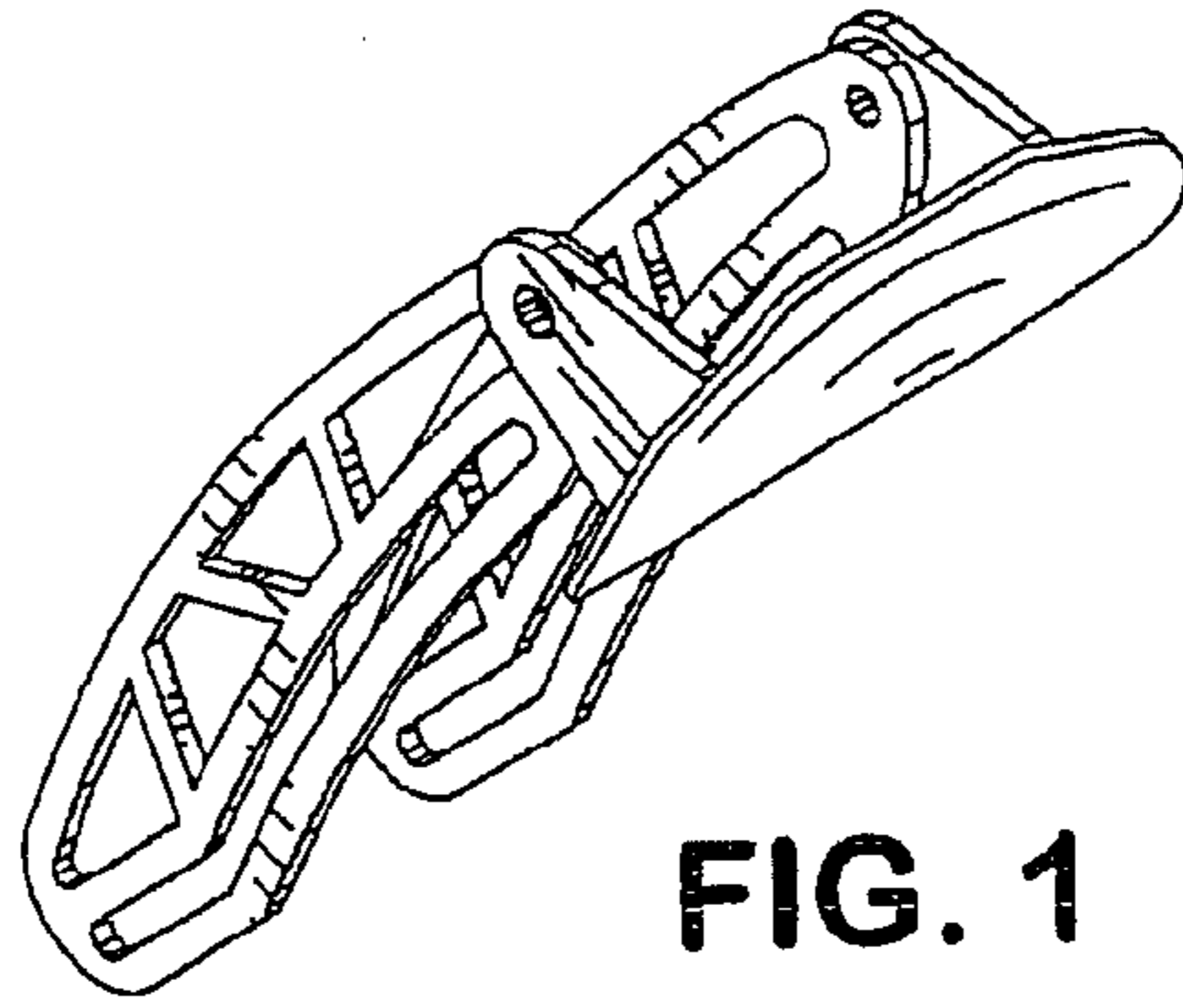

FIG. 1

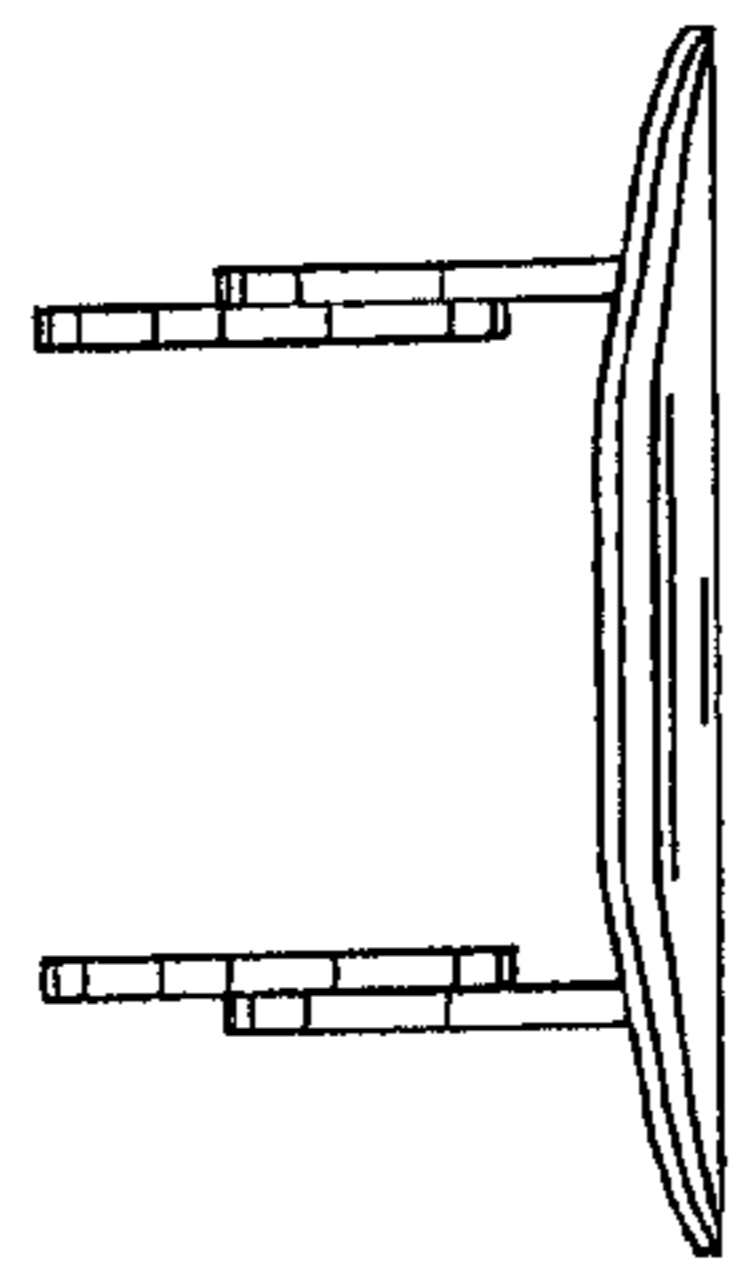

FIG. 2

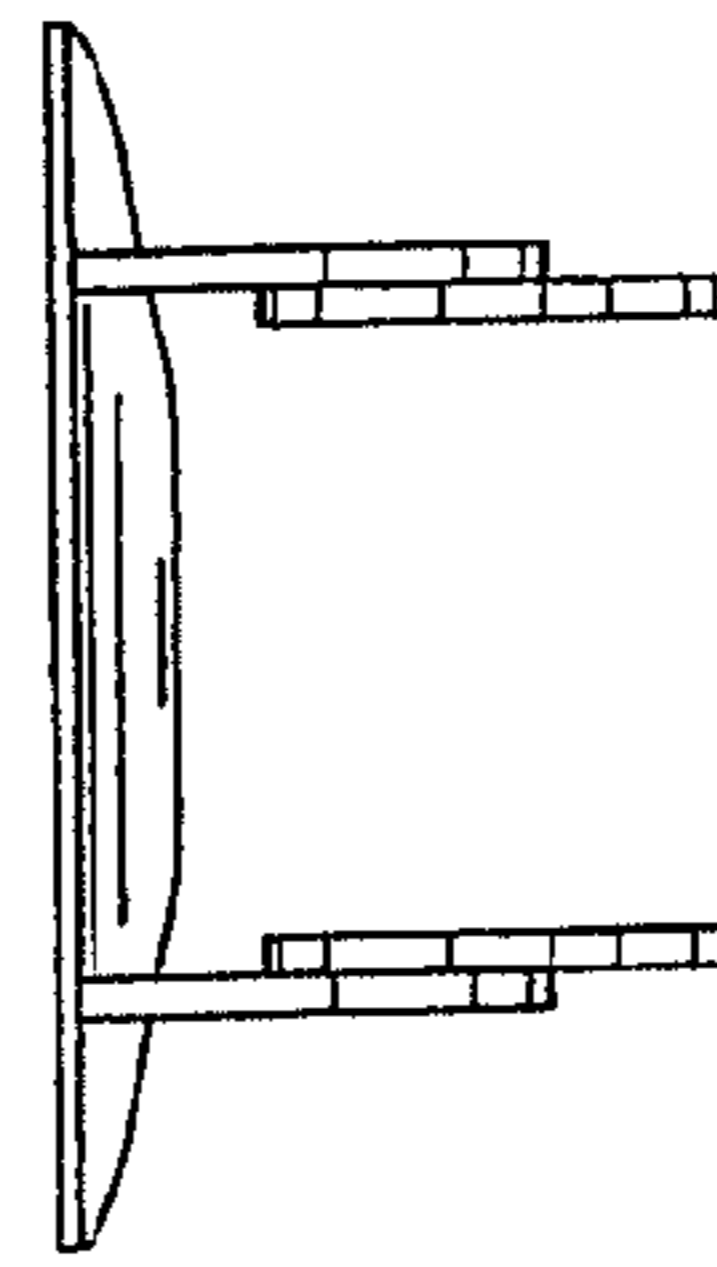

FIG. 3

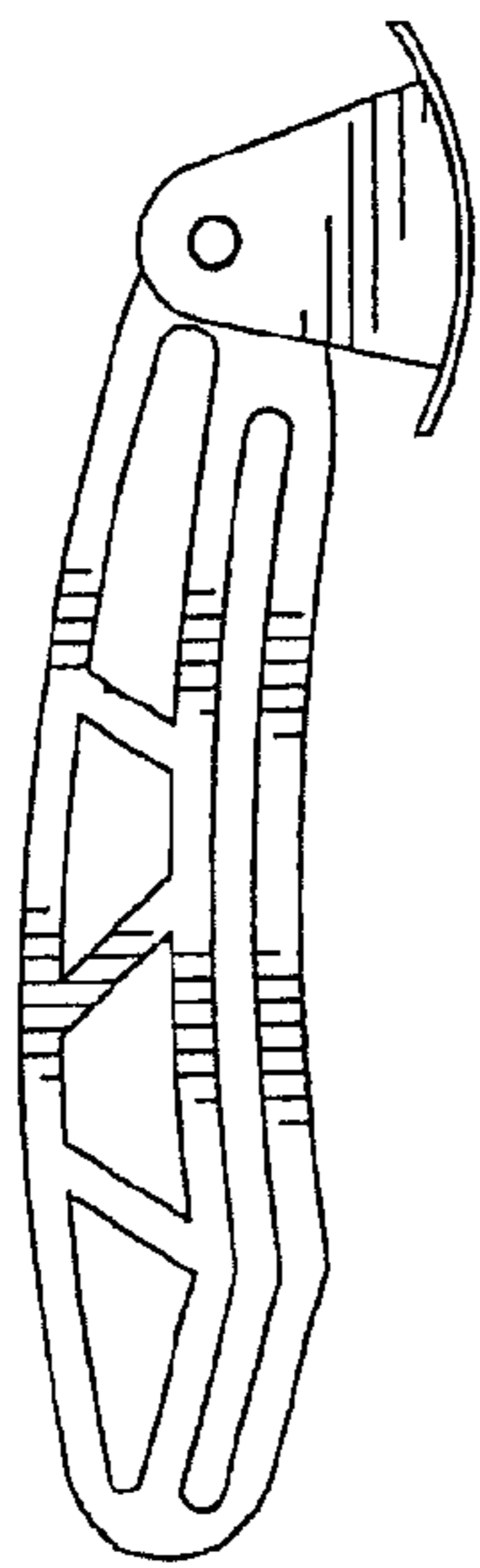

FIG. 4

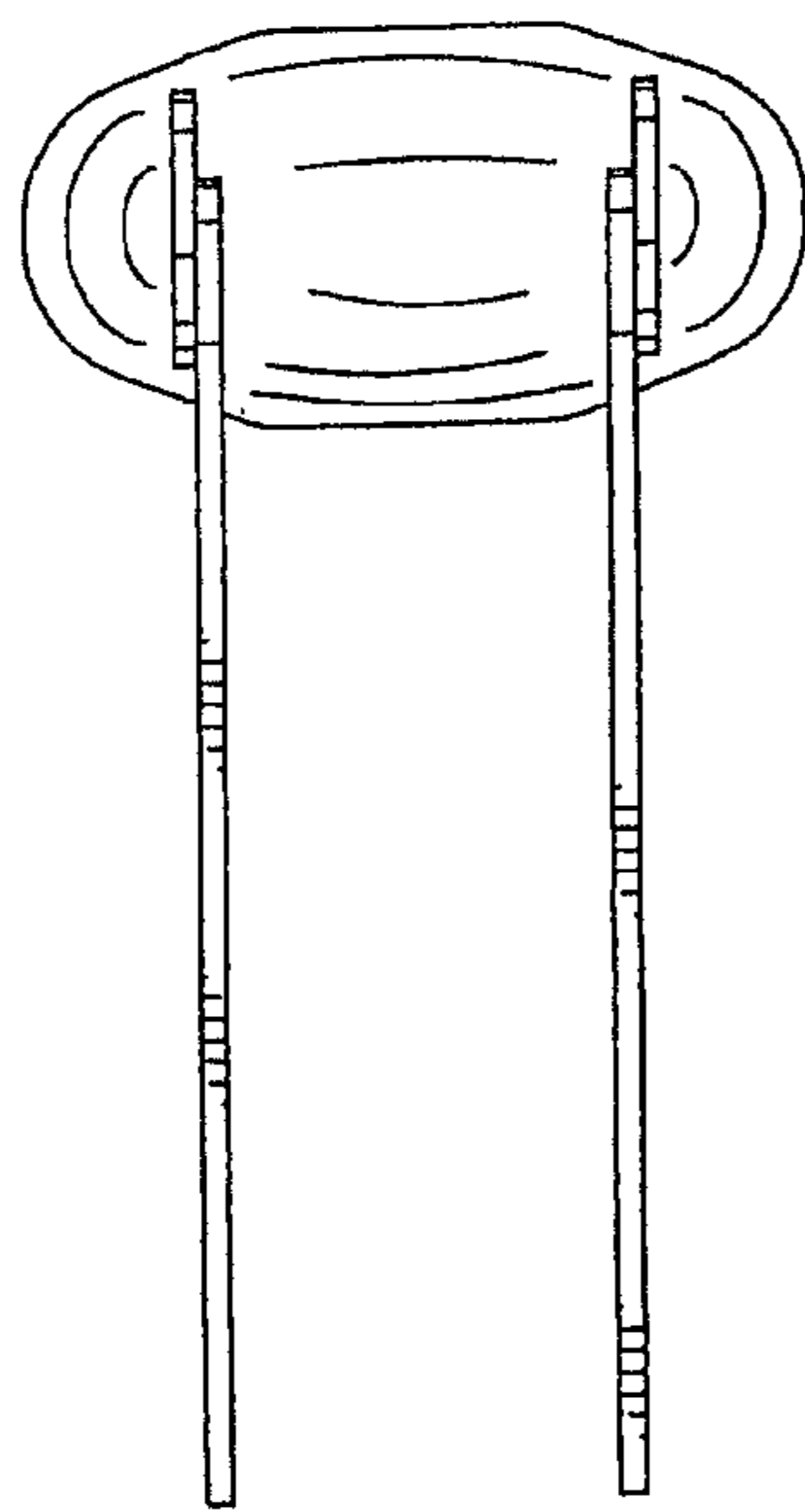

FIG. 5

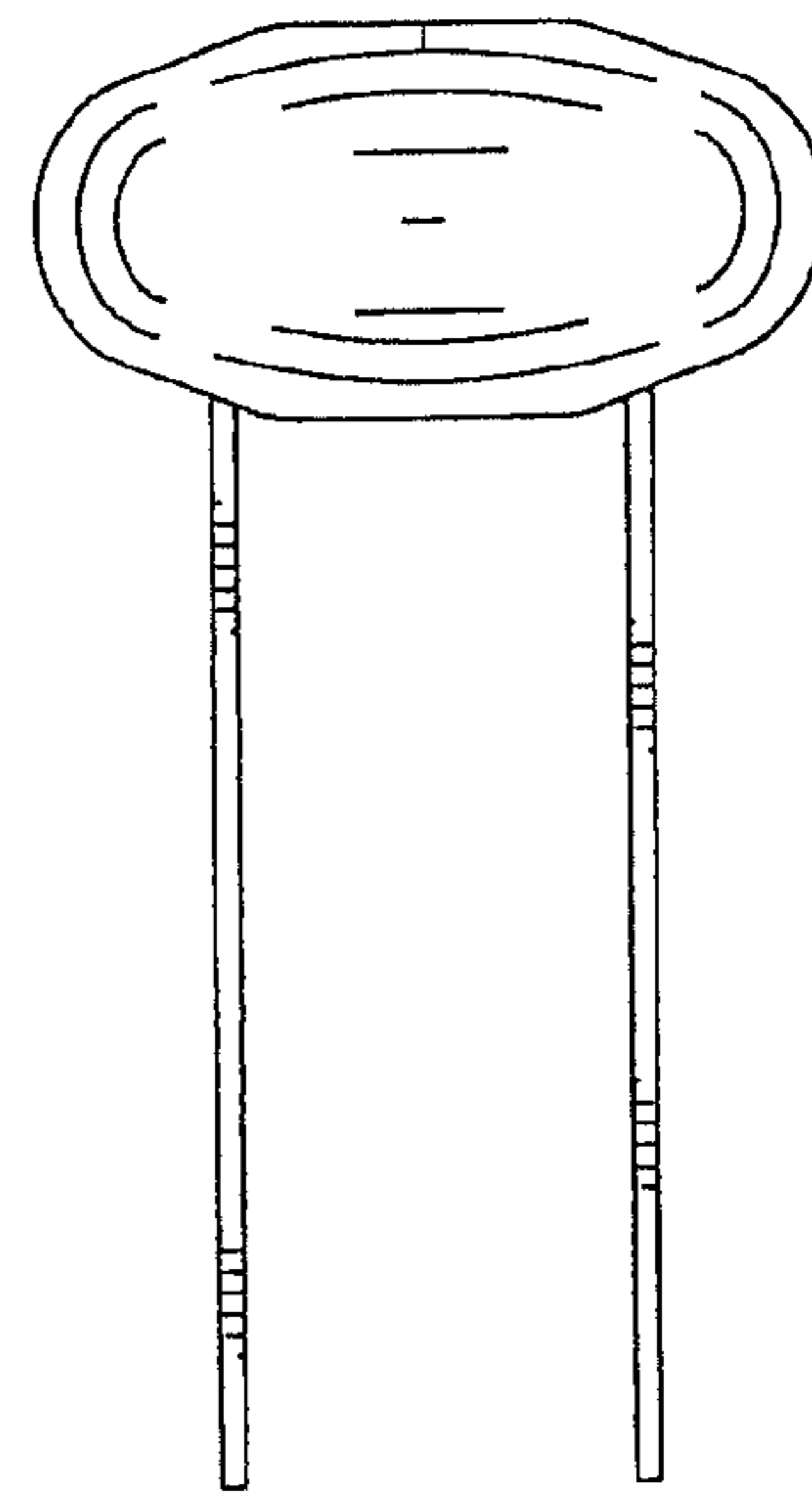

FIG. 6