



US00D570717S

(12) **United States Design Patent**  
**Elrod**

(10) **Patent No.:** **US D570,717 S**  
(45) **Date of Patent:** **\*\* Jun. 10, 2008**

(54) **METER CASE**

(75) Inventor: **Jeffrey M. Elrod**, Seattle, WA (US)

(73) Assignee: **Fluke Corporation**, Everett, WA (US)

(\*\*) Term: **14 Years**

(21) Appl. No.: **29/283,610**

(22) Filed: **Aug. 17, 2007**

(51) **LOC (8) Cl.** ..... **10-04**

(52) **U.S. Cl.** ..... **D10/78**

(58) **Field of Classification Search** ..... D10/78-79;  
324/72.5, 110, 114-115, 149, 151 A, 158 F,  
324/156; 340/653, 660; 439/482

See application file for complete search history.

(56) **References Cited**

**U.S. PATENT DOCUMENTS**

5,612,616 A *	3/1997	Earle	.....	324/72.5
D412,450 S *	8/1999	McCain	.....	D10/78
D427,919 S *	7/2000	Laverick et al.	.....	D10/78
D497,817 S *	11/2004	Lord	.....	D10/78
D520,888 S *	5/2006	Sydrowski et al.	.....	D10/78
D528,933 S *	9/2006	Hunter et al.	.....	D10/78
D558,621 S *	1/2008	Rich et al.	.....	D10/78

\* cited by examiner

*Primary Examiner*—Antoine D Davis

(74) *Attorney, Agent, or Firm*—Christensen O'Connor Johnson Kindness PLLC

(57) **CLAIM**

The ornamental design for a meter case, as shown and described.

**DESCRIPTION**

FIG. 1 is an isometric view of a meter case constructed in accordance with the present disclosure;

FIG. 2 is a planar view of a first surface of the meter case of FIG. 1;

FIG. 3 is a planar view of a second surface of the meter case of FIG. 1;

FIG. 4 is a planar view of a top side of the meter case of FIG. 1;

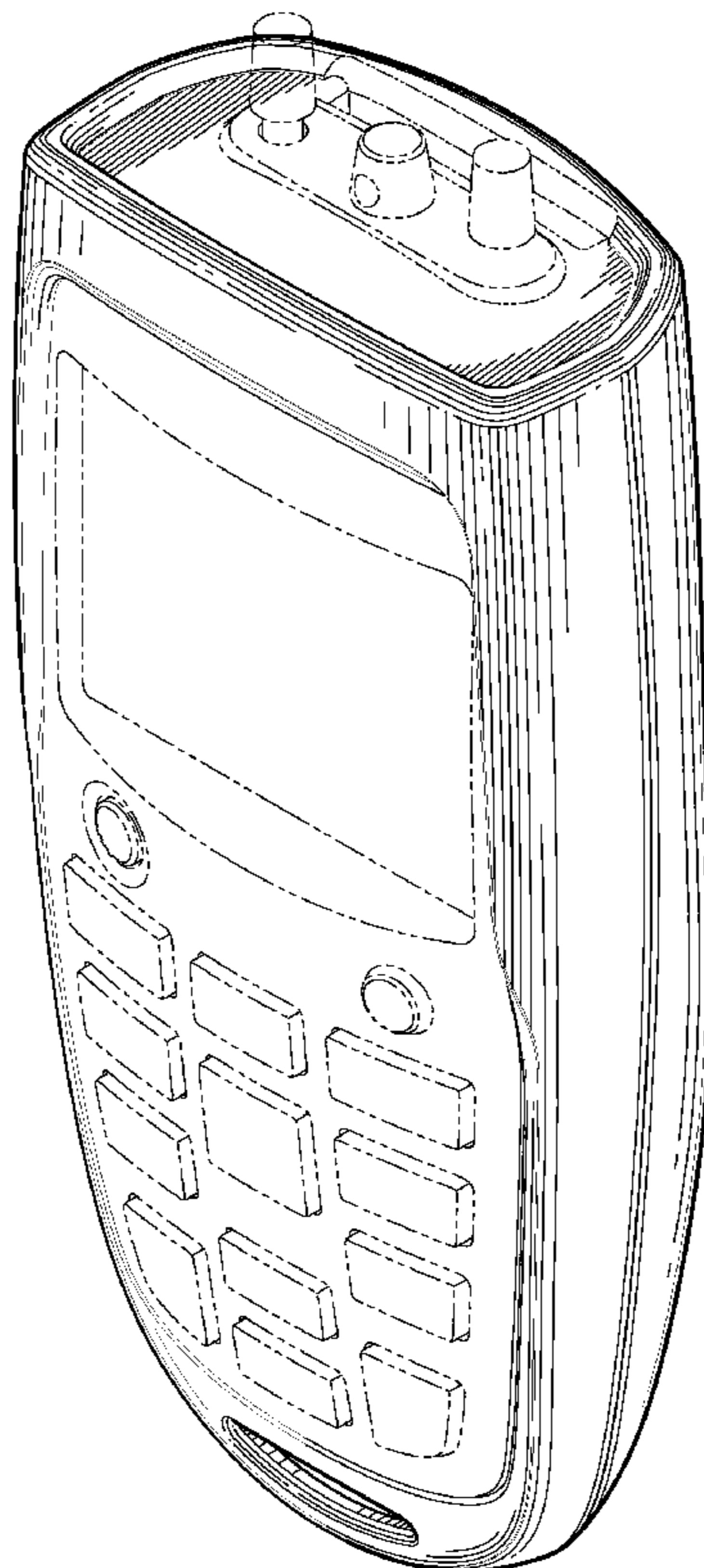
FIG. 5 is a planar view of a bottom side of the meter case of FIG. 1;

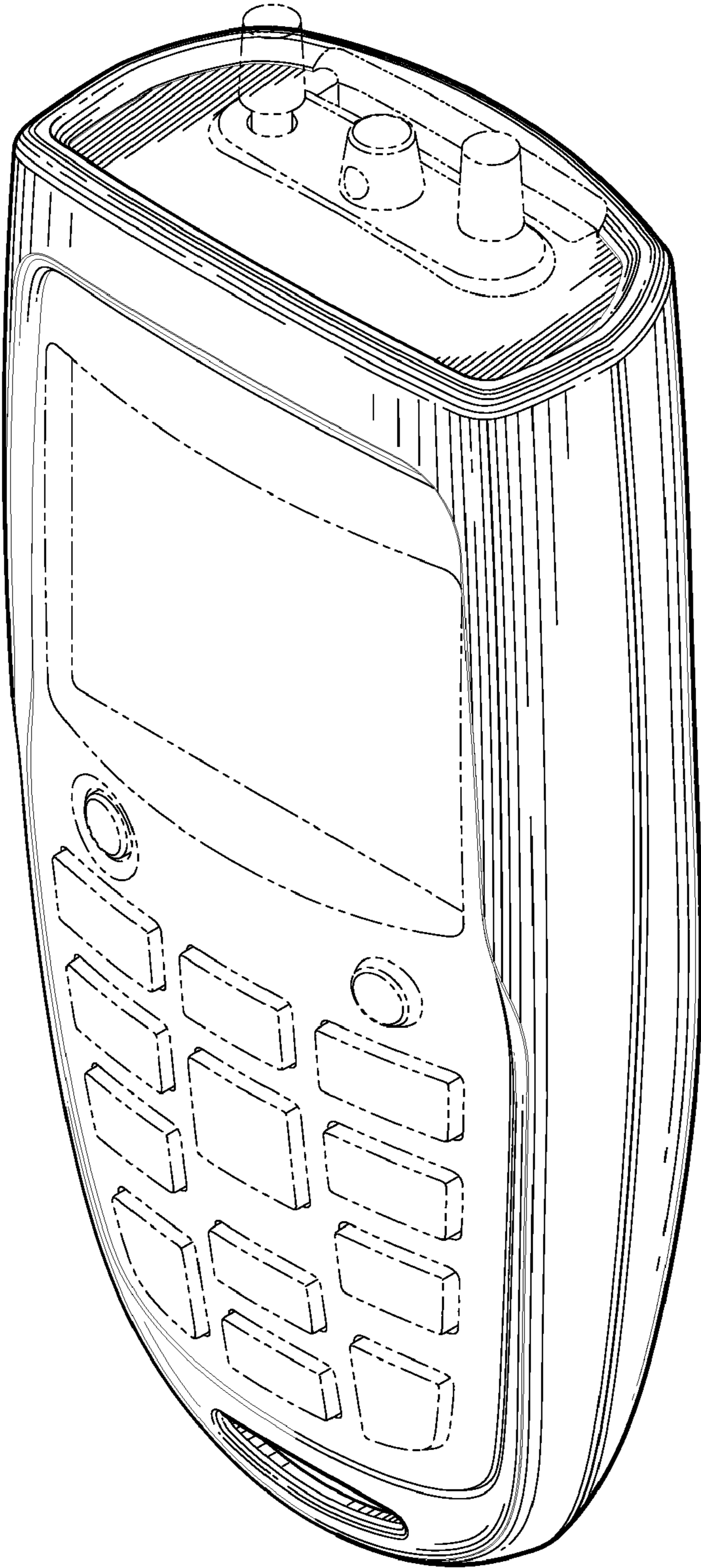
FIG. 6 is a planar view of a first side of the meter case of FIG. 1; and,

FIG. 7 is a planar view of a second side of the meter case of FIG. 1.

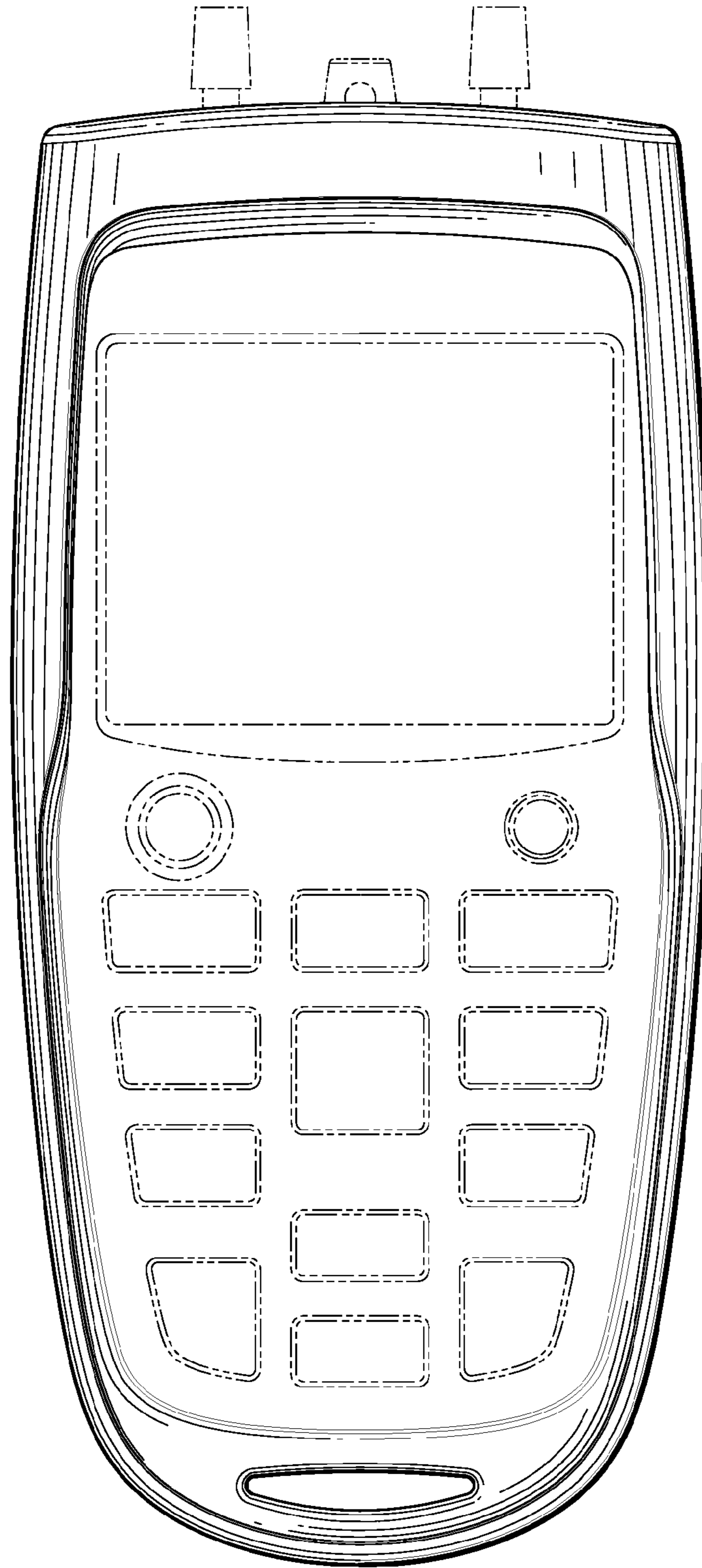
The subject matter shown in phantom lines is hereby disclaimed and forms no part of the claimed design.

**1 Claim, 5 Drawing Sheets**

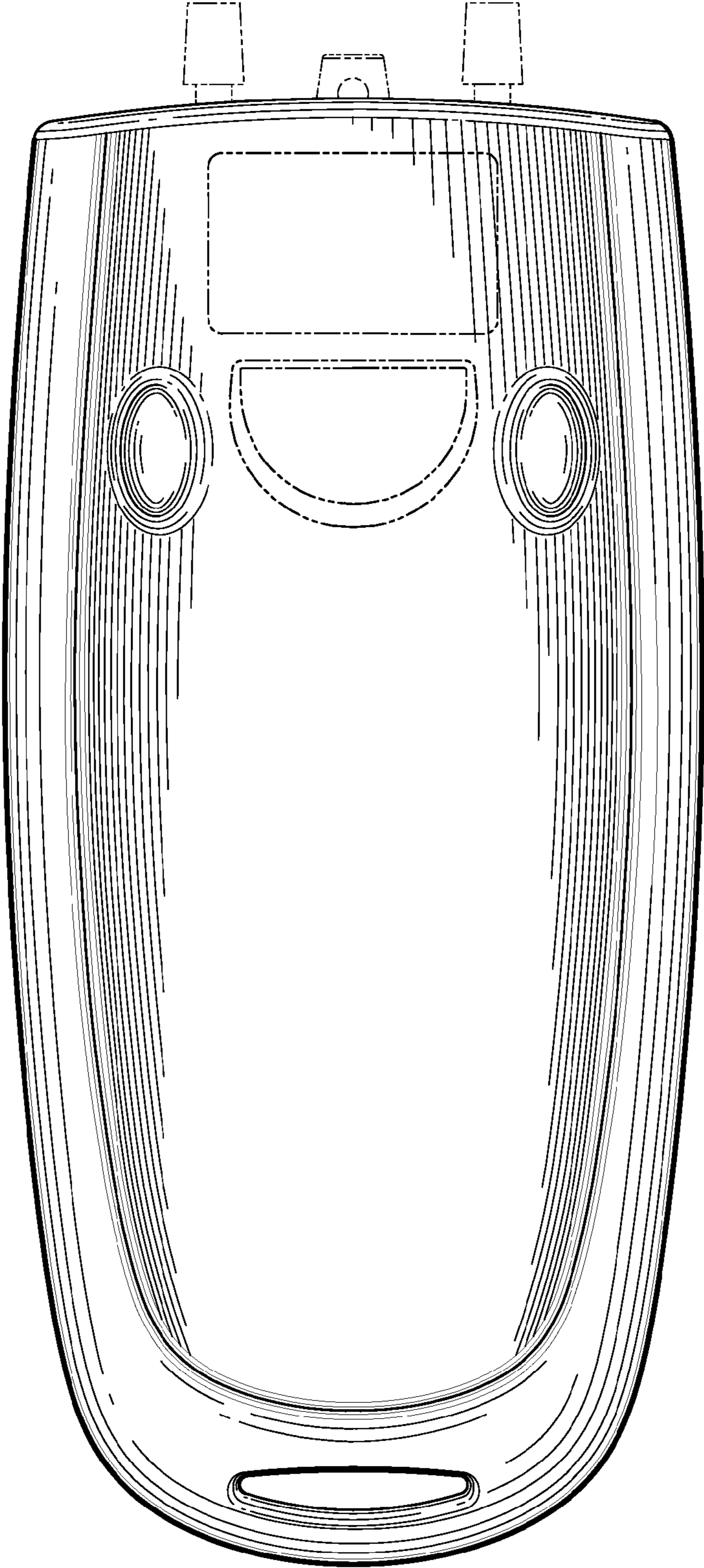




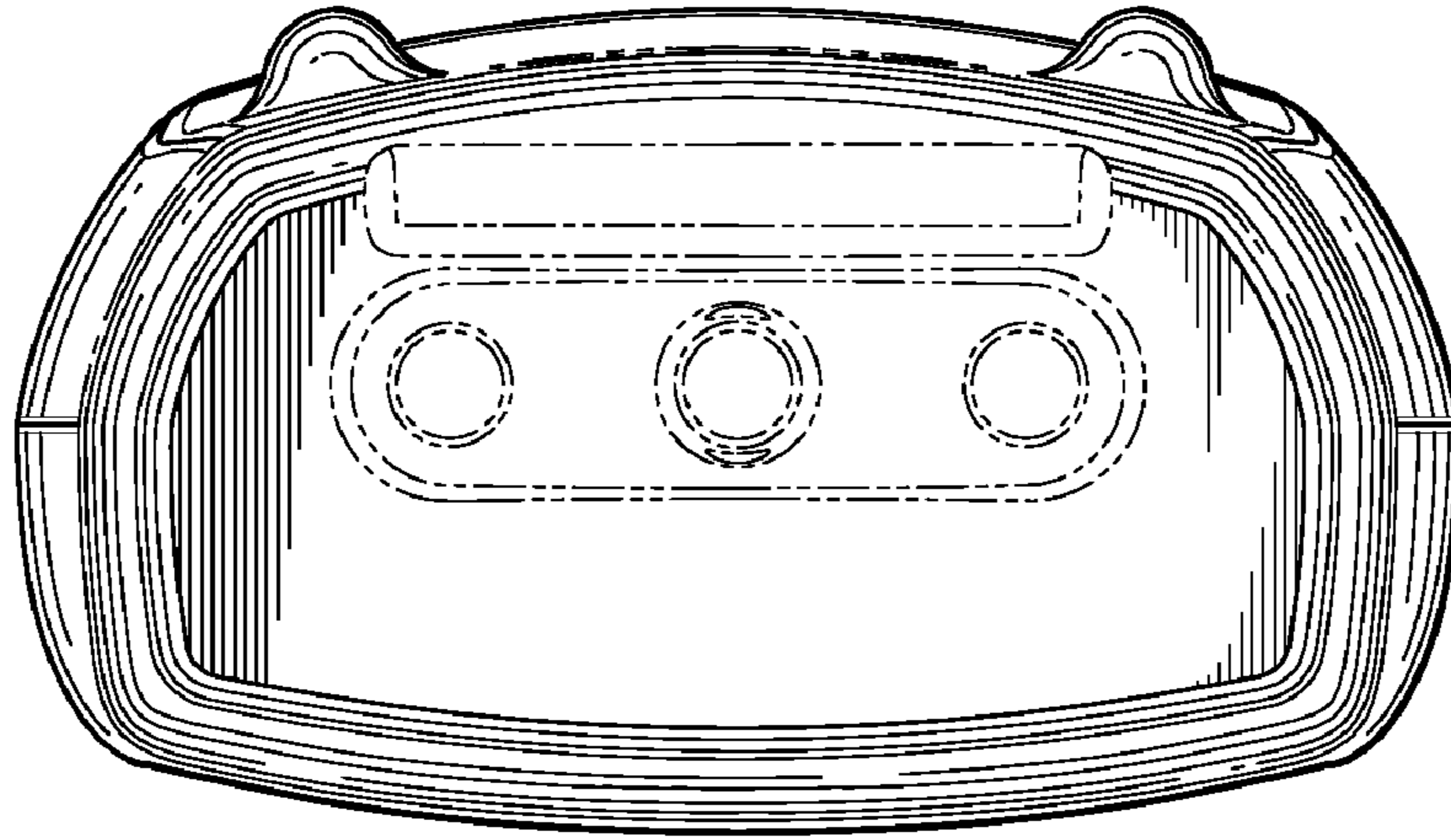
***Fig. 1.***



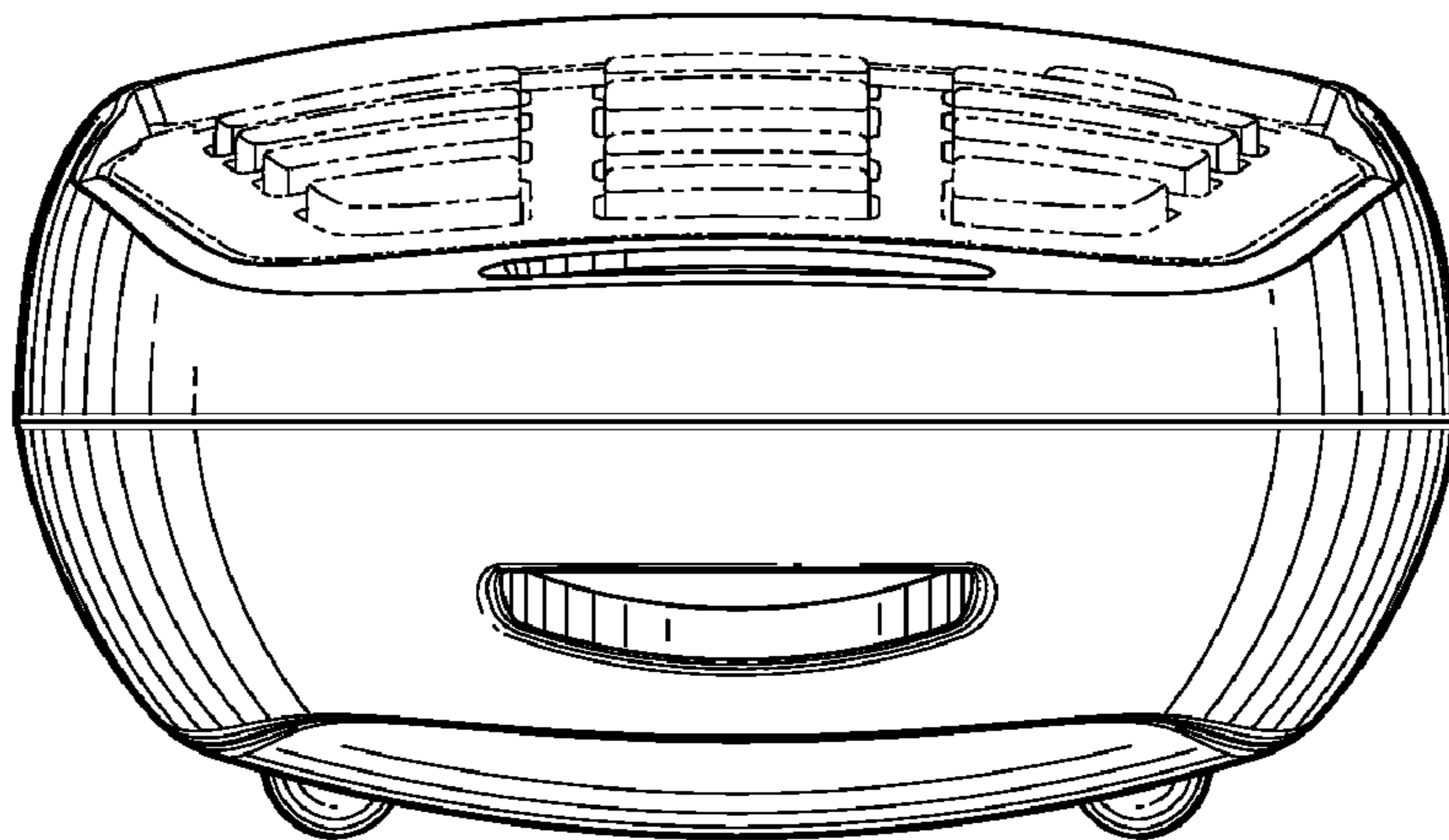
*Fig. 2*



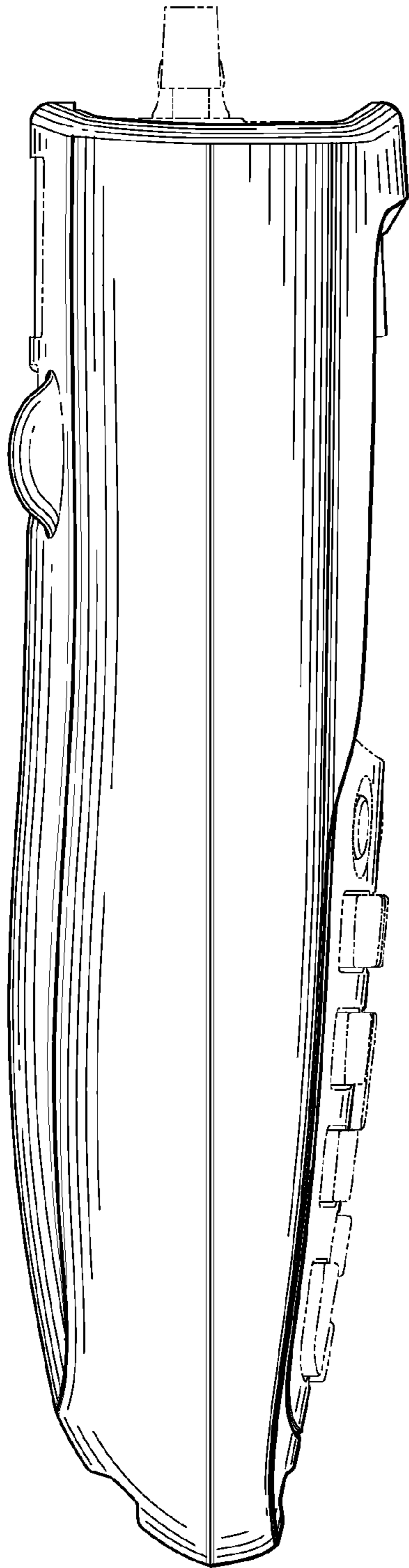
*Fig. 3.*



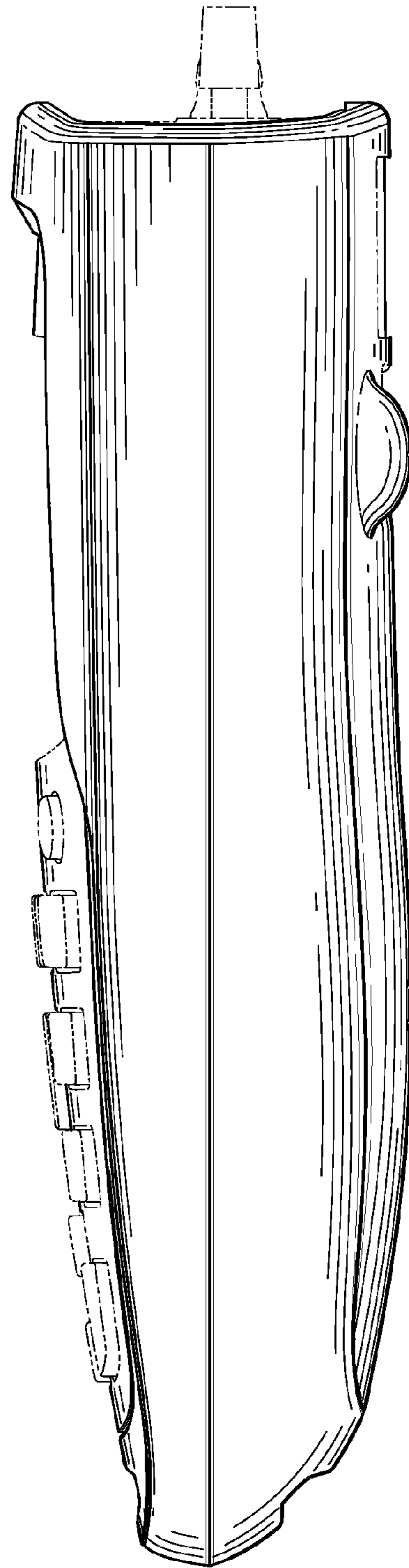
*Fig. 4.*



*Fig. 5.*



***Fig. 6.***



***Fig. 7.***