



US00D570598S

(12) **United States Design Patent**
Chan

(10) **Patent No.:** **US D570,598 S**
(45) **Date of Patent:** **** Jun. 10, 2008**

(54) **CASE FOR ELECTRICAL DEVICE**

(75) Inventor: **James Chan**, San Marino, CA (US)
(73) Assignee: **Belkin International, Inc.**, Compton, CA (US)
(**) Term: **14 Years**
(21) Appl. No.: **29/272,698**
(22) Filed: **Feb. 12, 2007**

(51) **LOC (8) Cl.** **03-01**
(52) **U.S. Cl.** **D3/218**
(58) **Field of Classification Search** D3/218,
D3/215, 219, 224, 226, 232-253, 294; 224/250,
224/197, 666, 674, 605, 930, 602, 904, 240,
224/236, 625, 664; 206/320, 581
See application file for complete search history.

(56) **References Cited**

U.S. PATENT DOCUMENTS

D356,120 S *	3/1995	Allen	D3/249
D390,590 S *	2/1998	Bedol	D3/249
D501,718 S *	2/2005	Brown	D3/247
D525,422 S *	7/2006	Williams et al.	D3/218
2001/0035444 A1 *	11/2001	Alis	224/250
2006/0243772 A1	11/2006	Sirichai et al.	224/666

* cited by examiner

Primary Examiner—Catherine R Oliver
(74) *Attorney, Agent, or Firm*—Bryan Cave LLP

(57) **CLAIM**

I claim the ornamental design for a case for electrical device, as shown.

DESCRIPTION

FIG. 1 is a front view of the case in a closed configuration; FIG. 2 is a top view of the case in a closed configuration; FIG. 3 is a back view of the case in the closed configuration; FIG. 4 is a right view of the case in the closed configuration; FIG. 5 is a back, left isometric view of the case in the closed configuration; FIG. 6 is a left view of the case in the closed configuration; FIG. 7 is a bottom view of the case in the closed configuration; FIG. 8 is a front view of the case in an open configuration; FIG. 9 is a bottom view of the case in the open configuration; FIG. 10 is a top, back isometric view of the case in the open configuration; FIG. 11 is a right, top isometric view of the case in the open configuration; FIG. 12 is a top, left isometric view of the case in the open configuration; FIG. 13 is a left, top isometric view of the case in the open configuration; and, FIG. 14 is a top view of the case in the open configuration. The broken lines in the drawings are for illustrative purposes only and form no part of the claimed design.

1 Claim, 11 Drawing Sheets

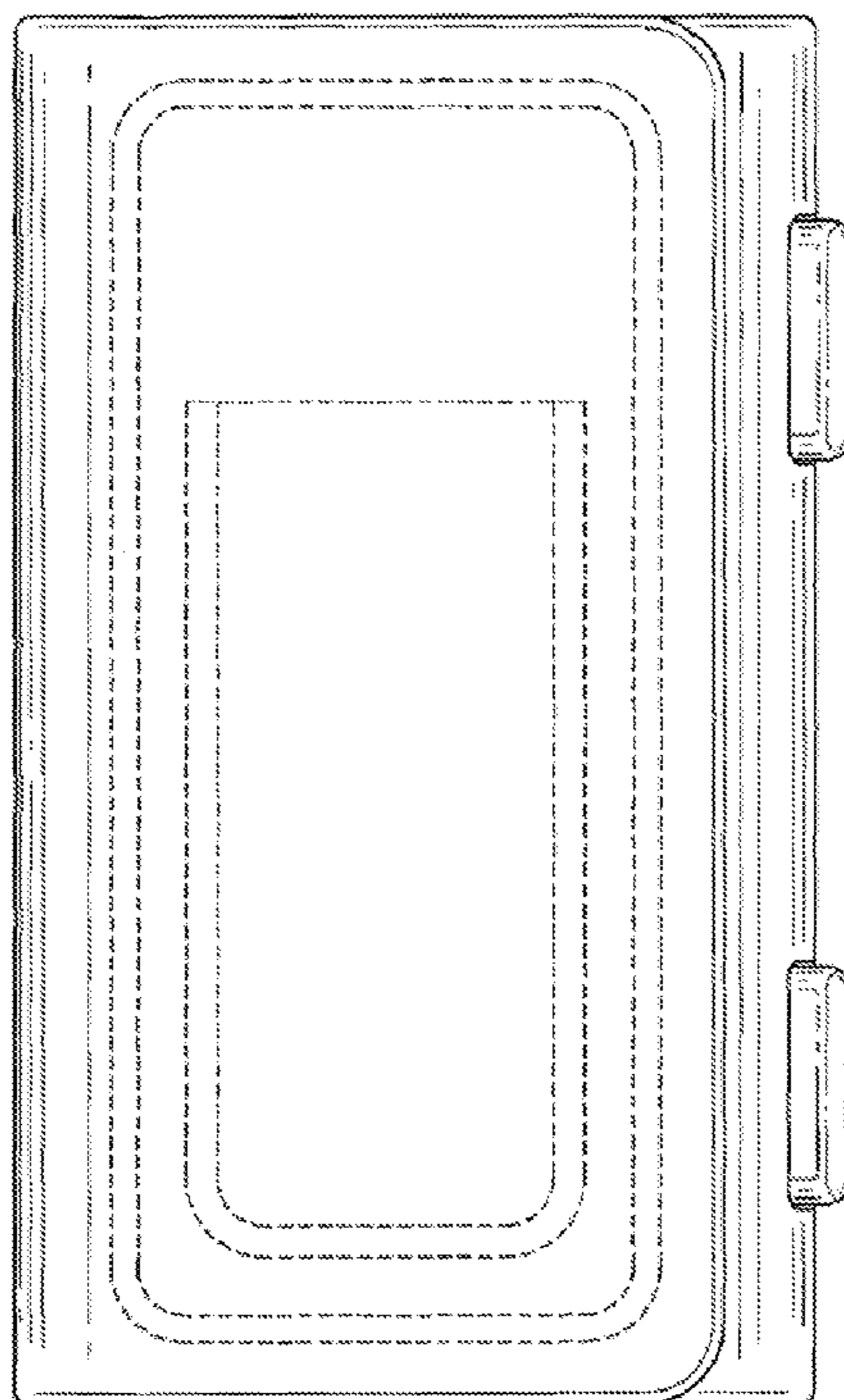

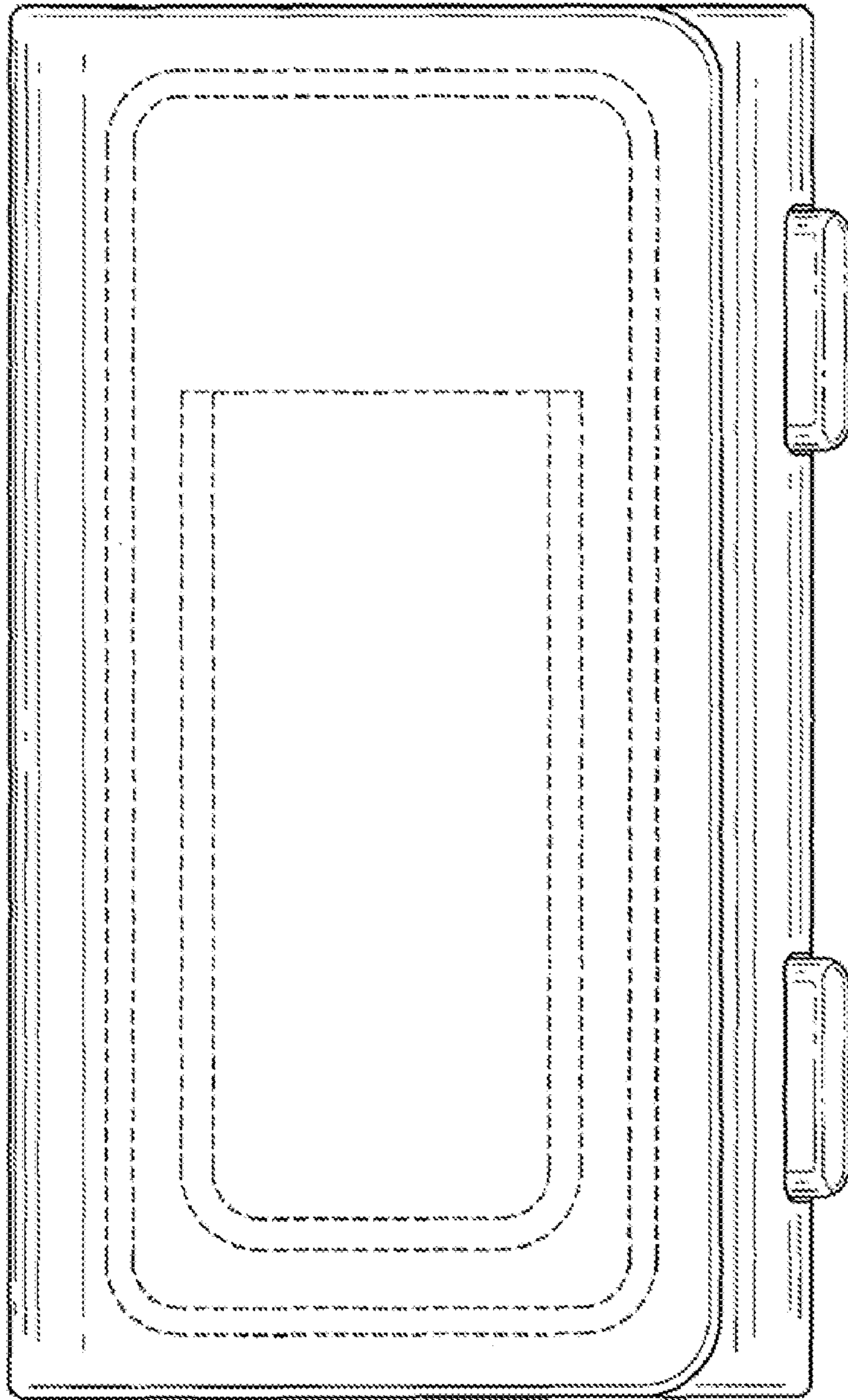

FIG. 1

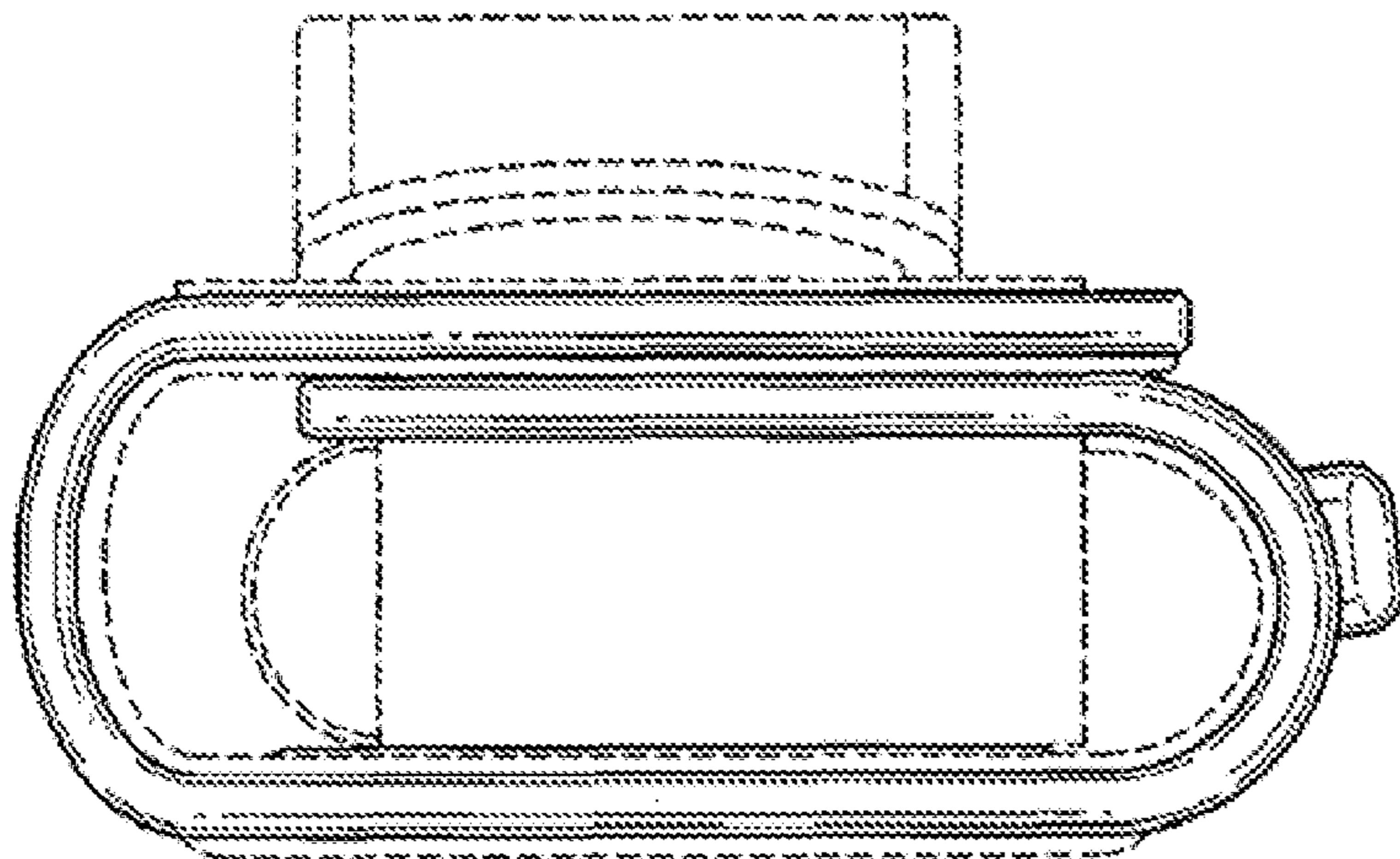

FIG. 2

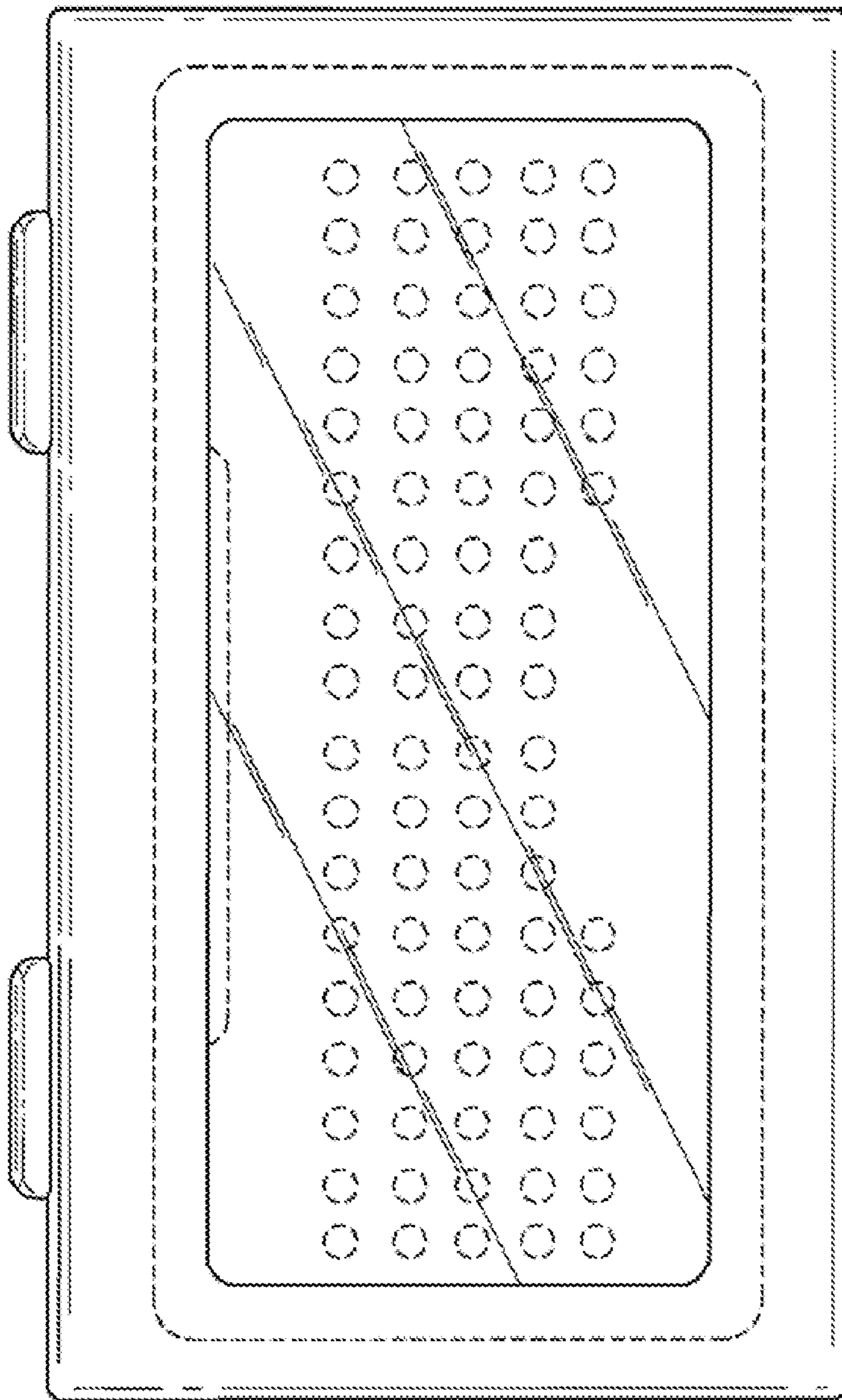

FIG. 3

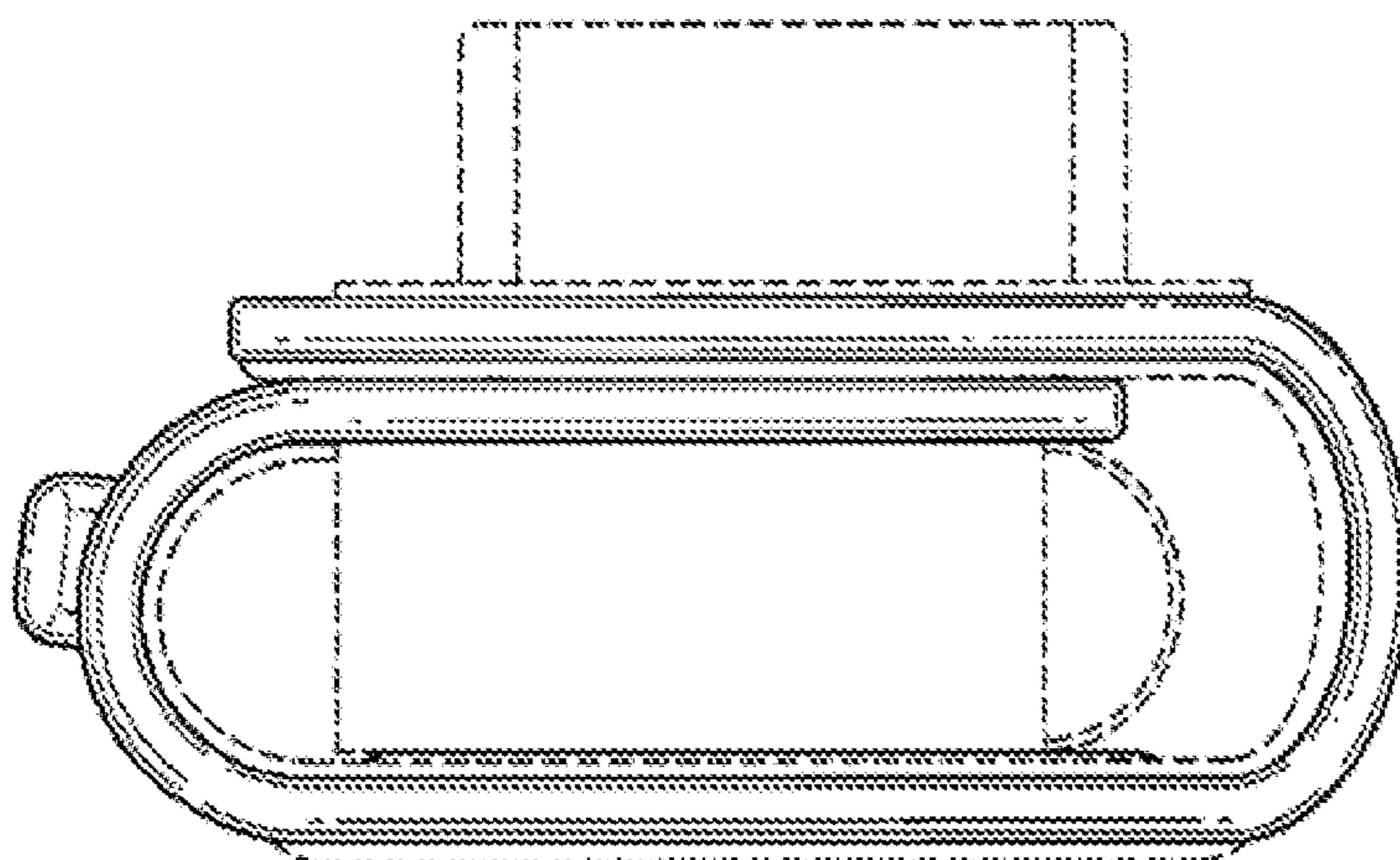

FIG. 7

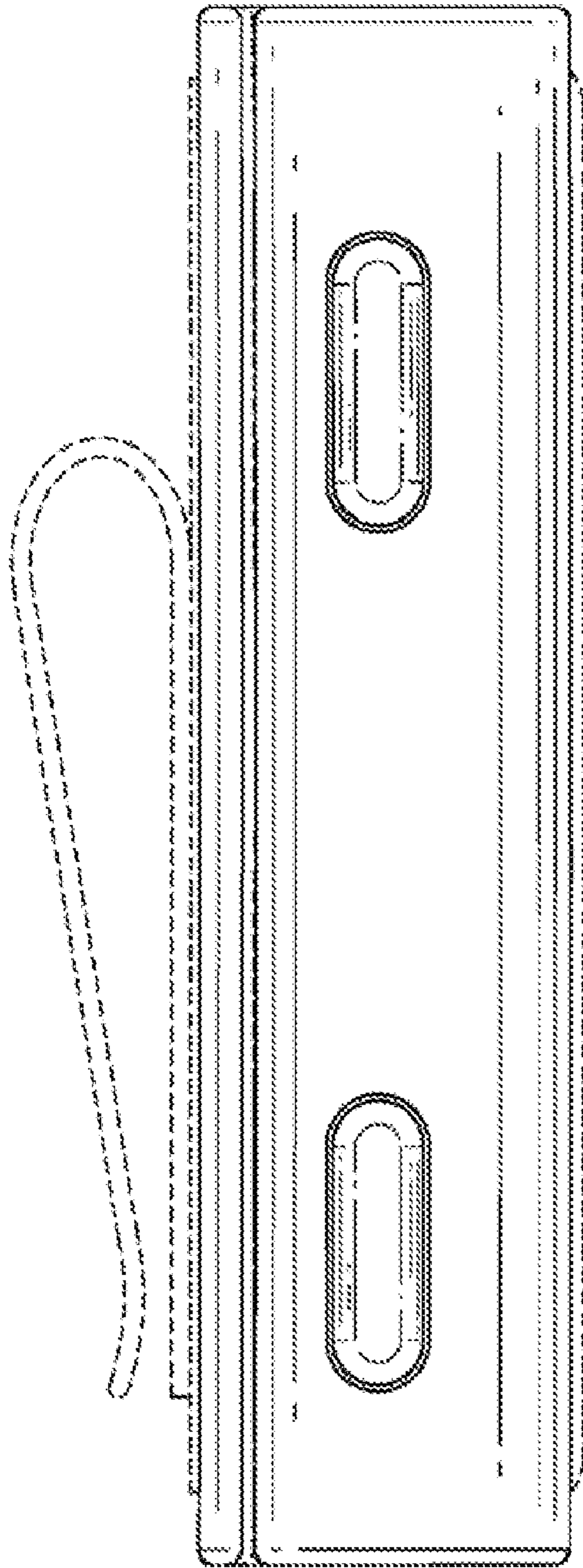

FIG. 4

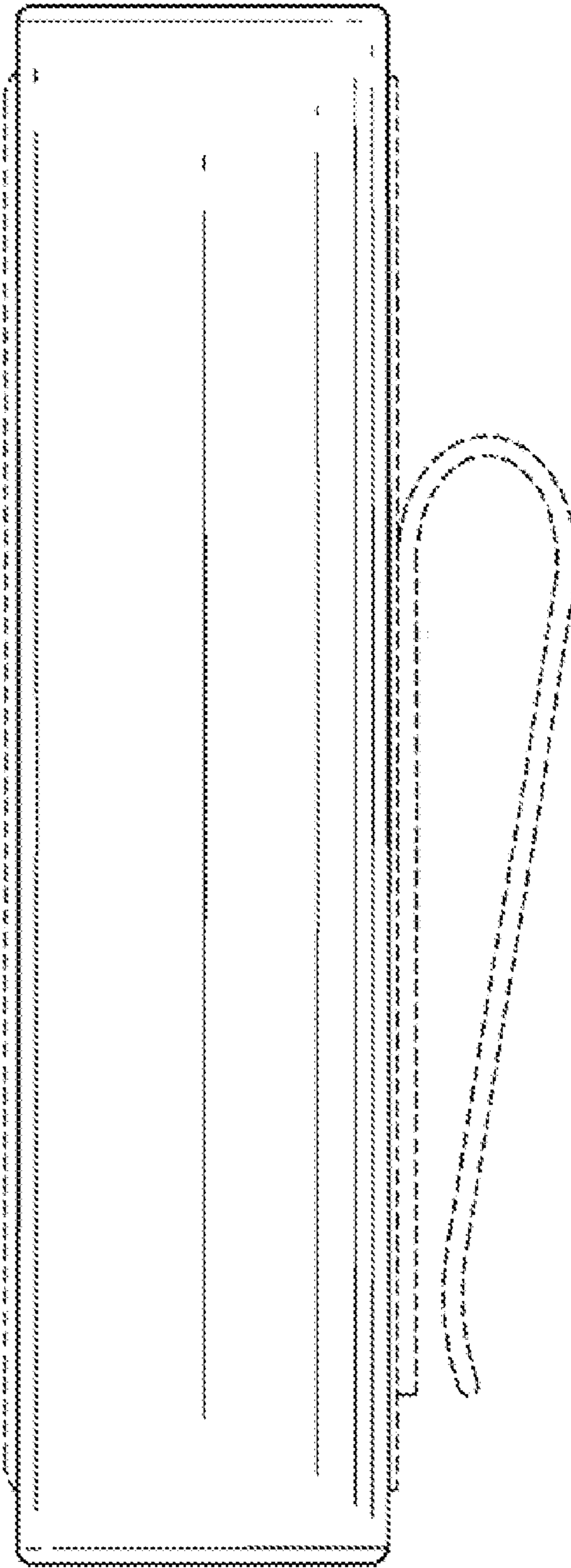

FIG. 6

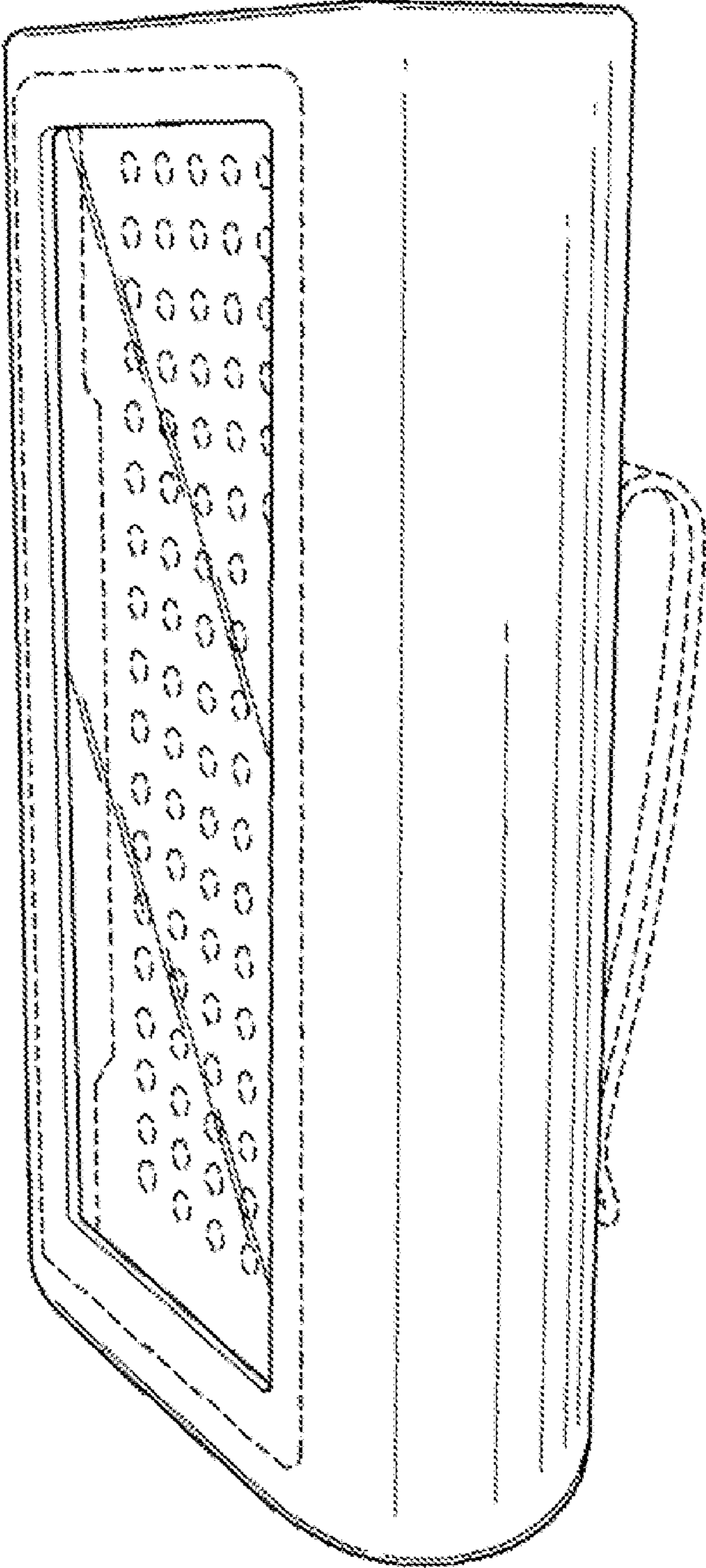

FIG. 5

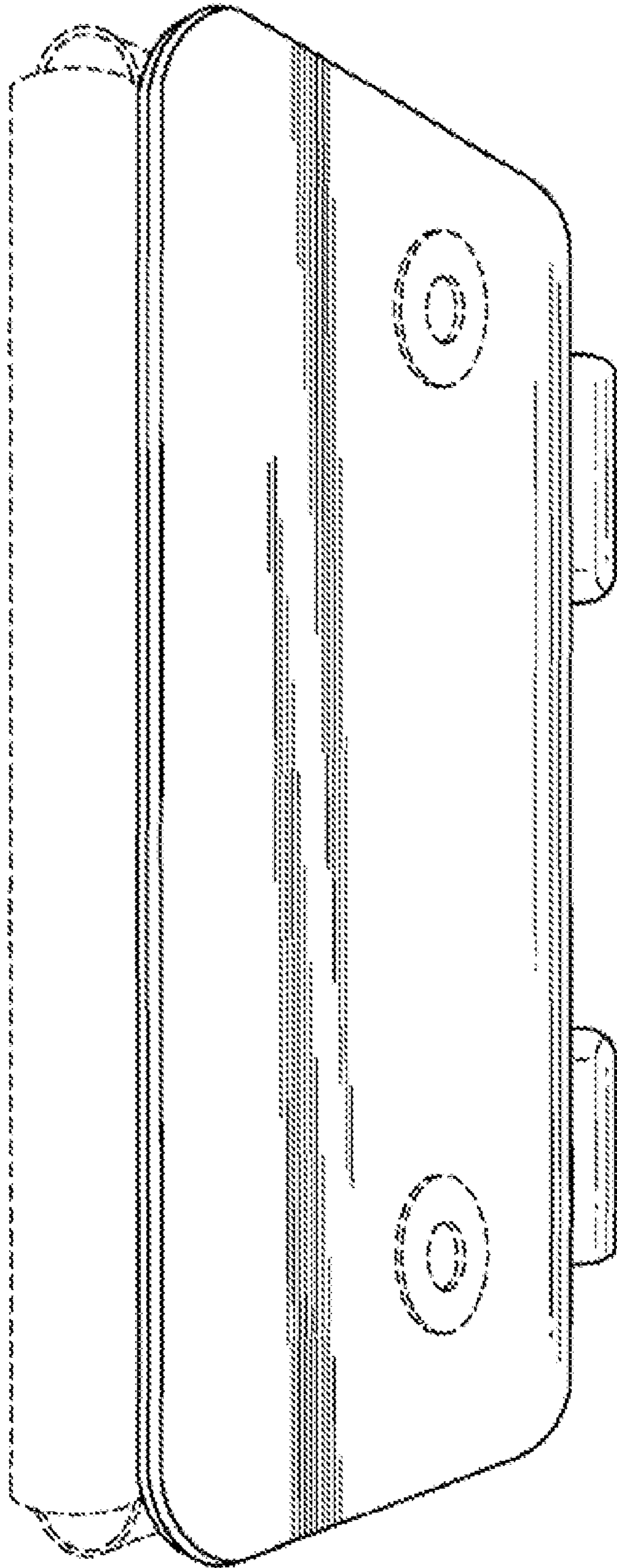

FIG. 8

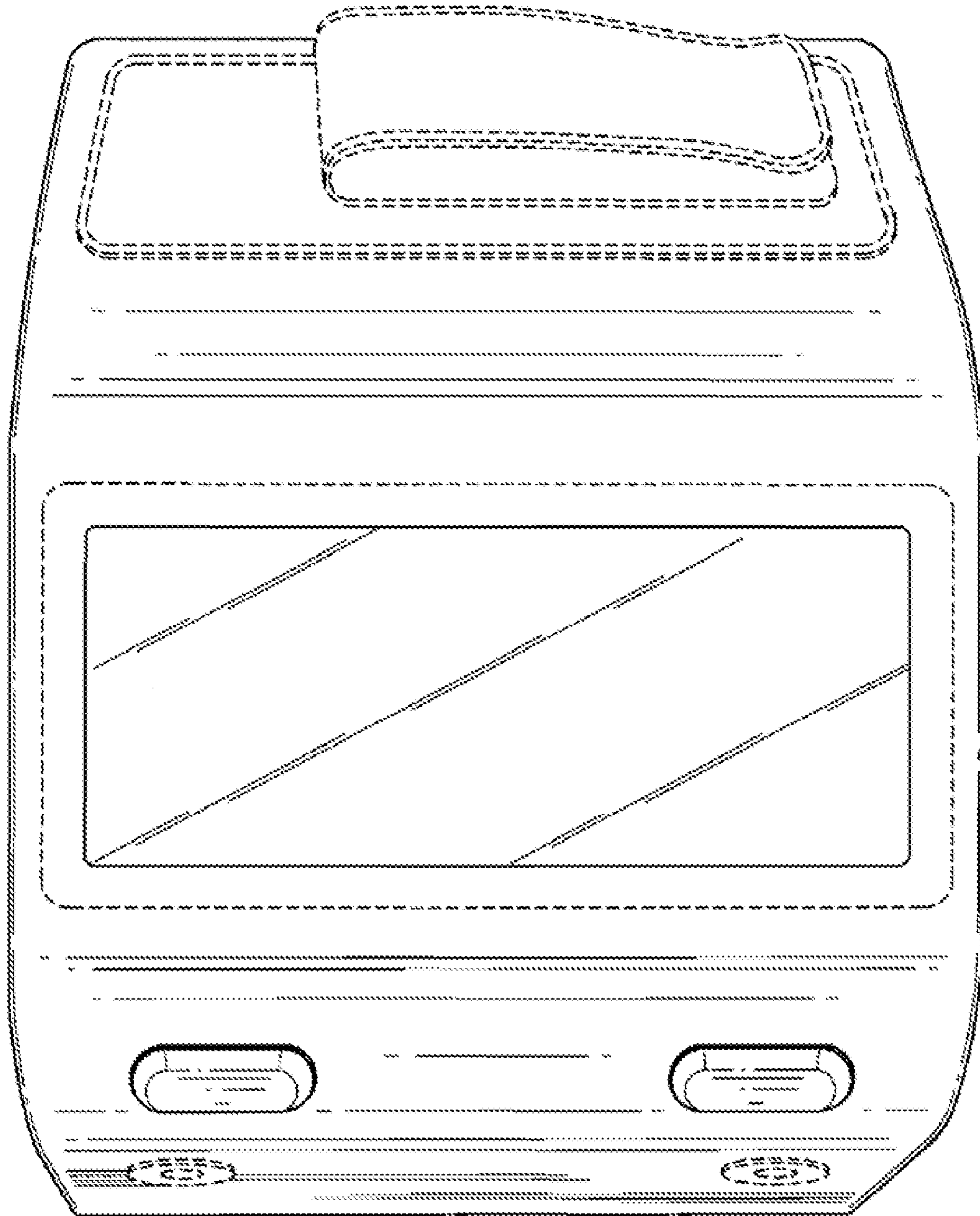

FIG. 9

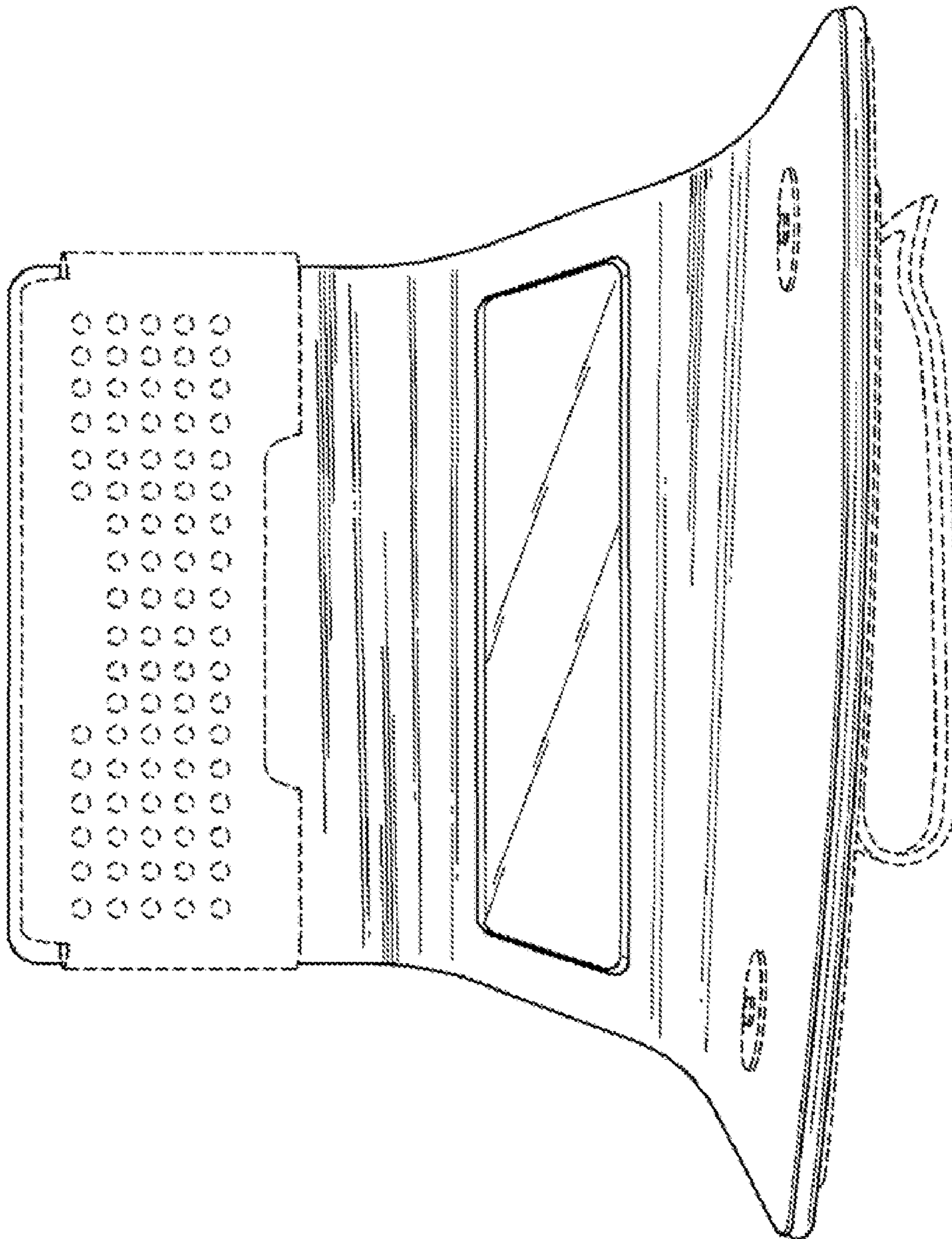

FIG. 10

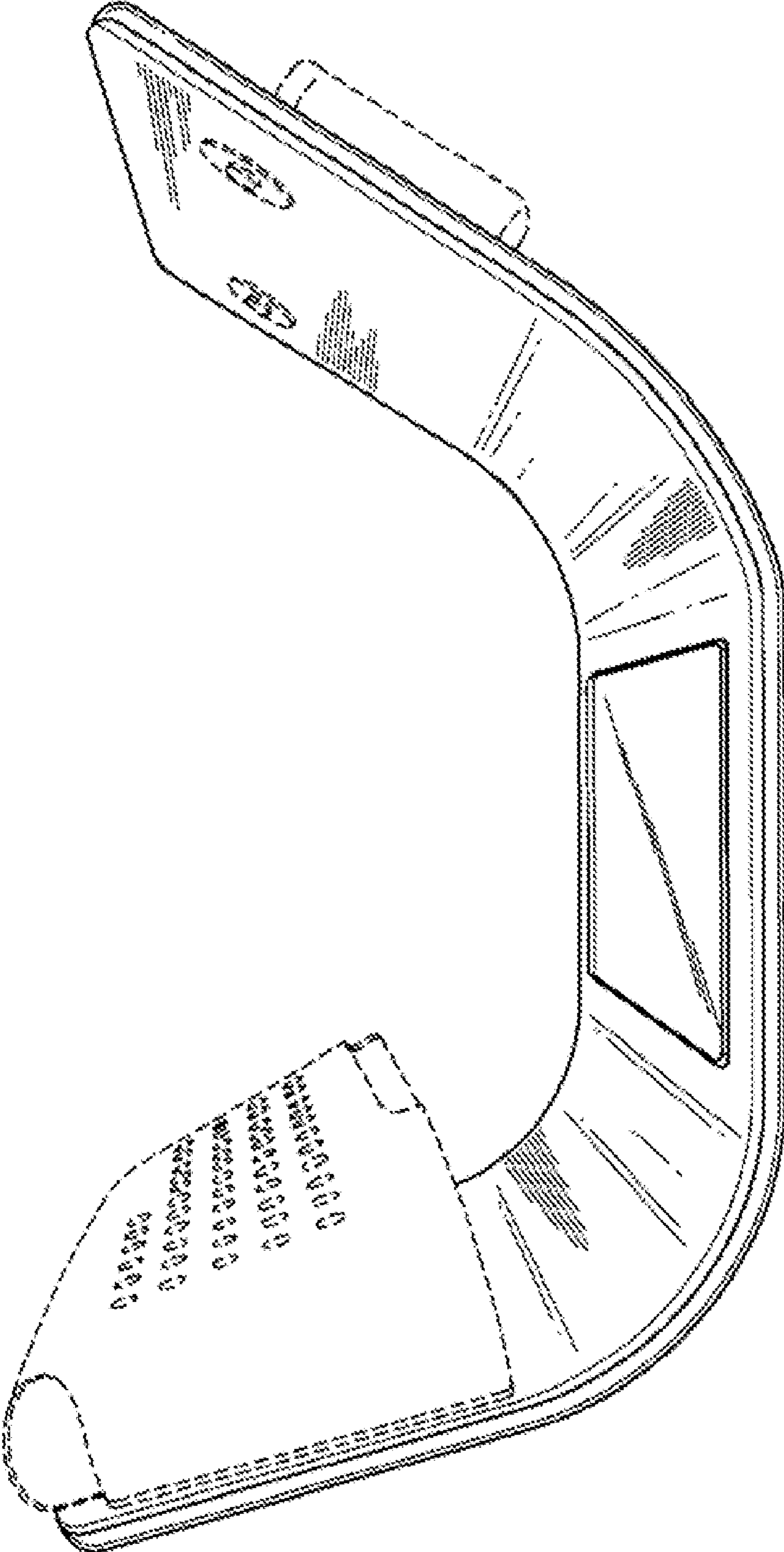

FIG. 11

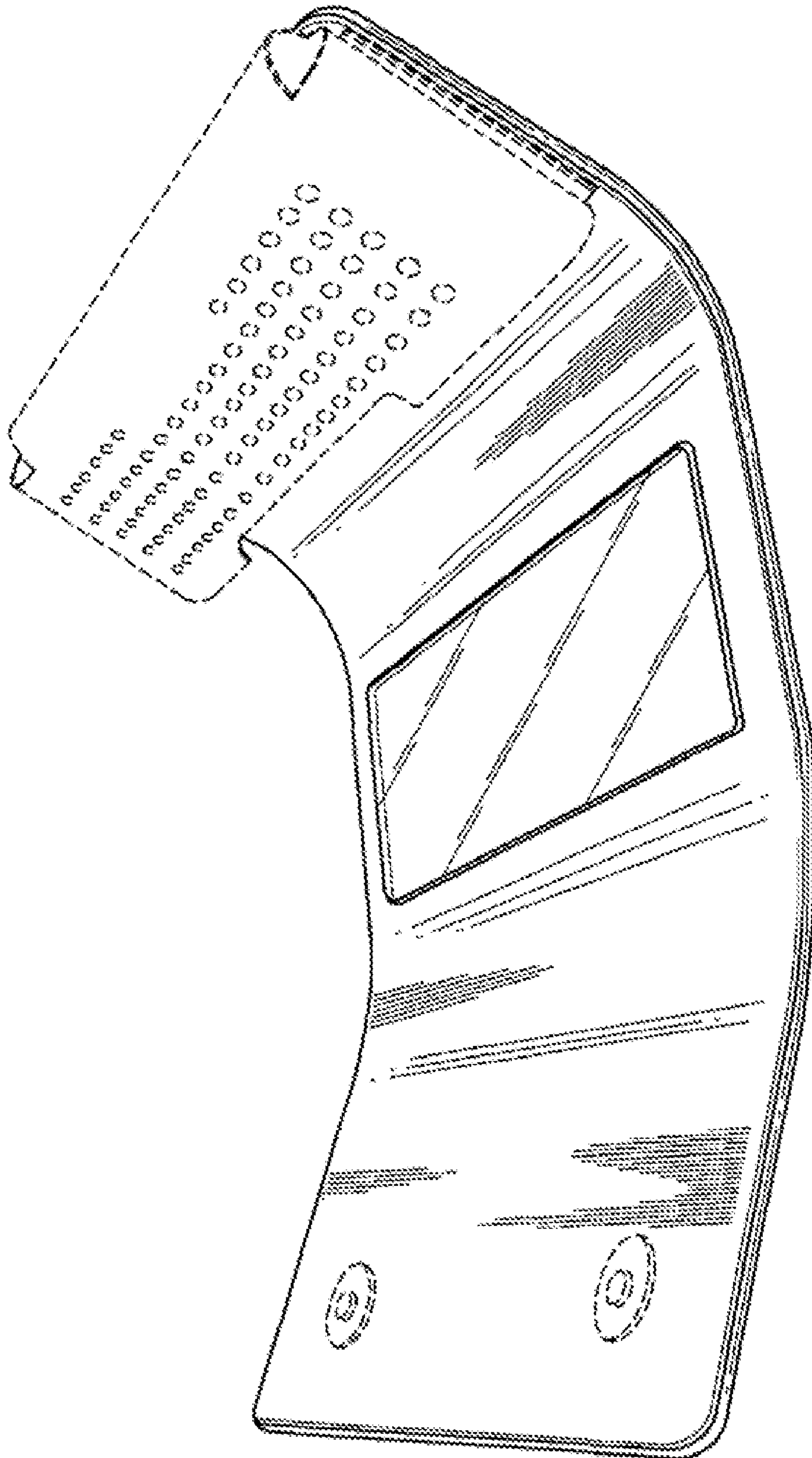

FIG. 12

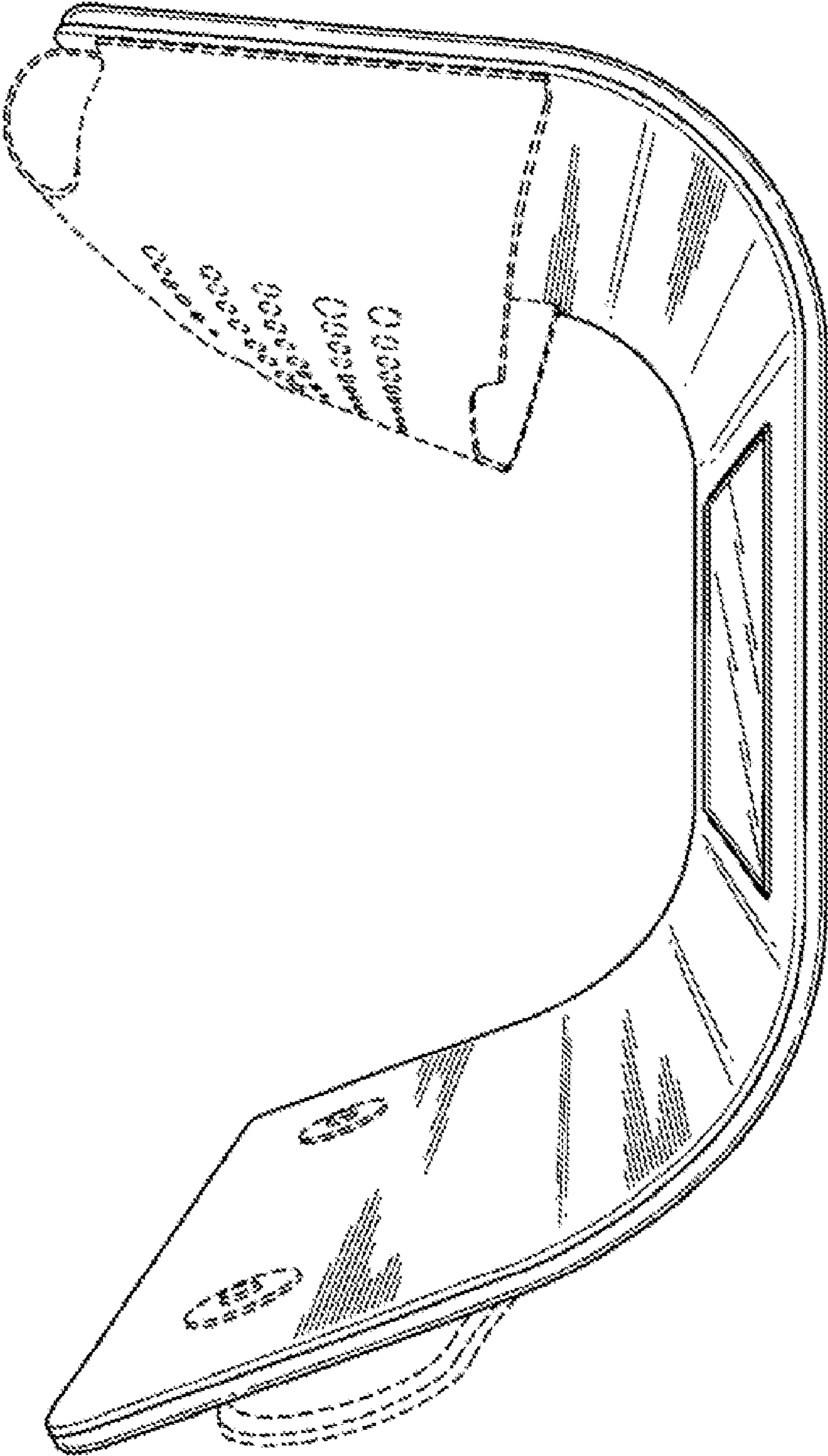

FIG. 13

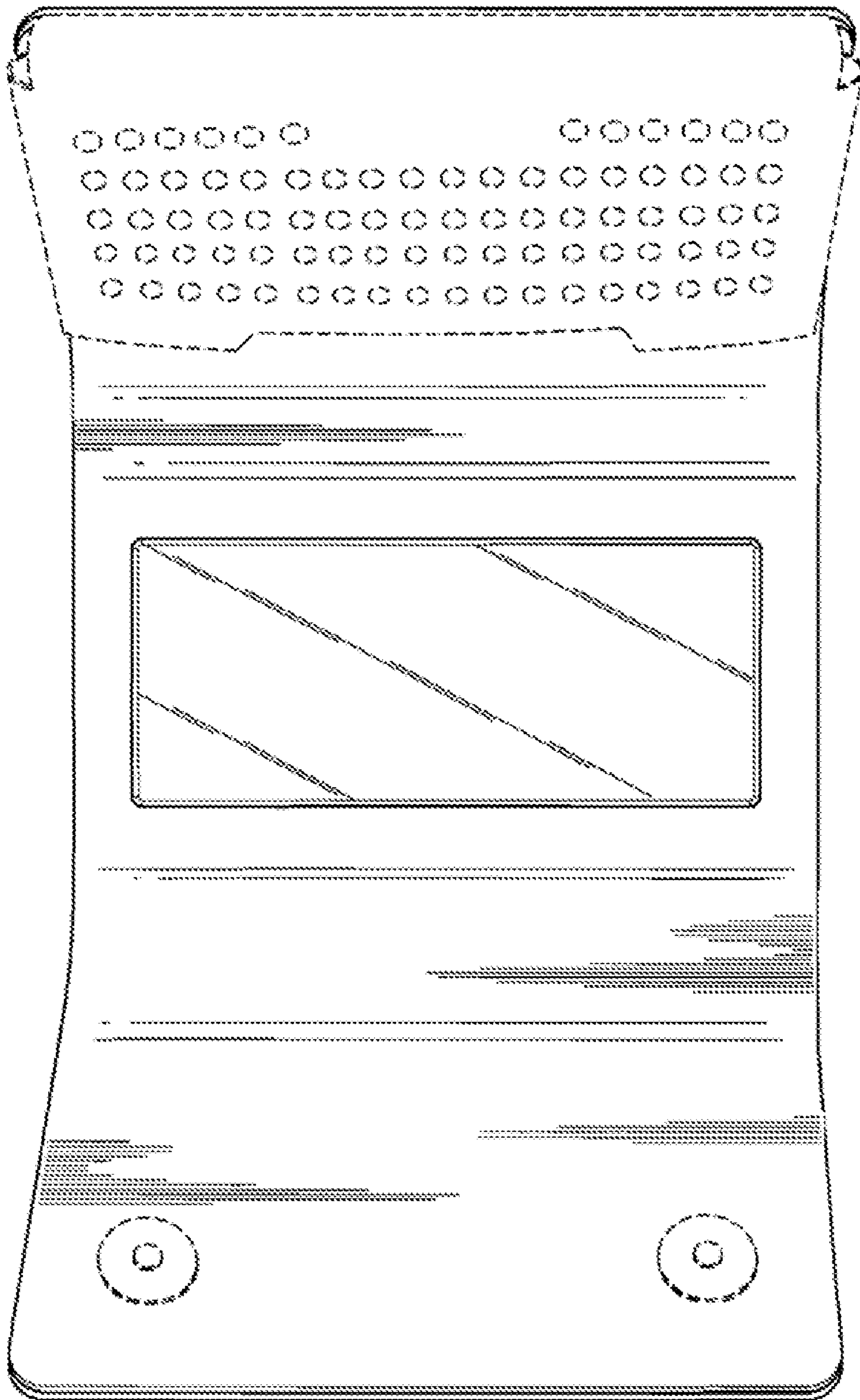

FIG. 14