

US00D570326S

(12) **United States Design Patent**
Chang

(10) **Patent No.:** **US D570,326 S**

(45) **Date of Patent:** **** Jun. 3, 2008**

(54) **INTERNET PHONE**

(75) Inventor: **Chao-Han Chang**, Taipei (TW)

(73) Assignee: **Pchome Online Inc.**, Taipei (TW)

(**) Term: **14 Years**

(21) Appl. No.: **29/264,691**

(22) Filed: **Aug. 16, 2006**

(51) **LOC (8) Cl.** **14-03**

(52) **U.S. Cl.** **D14/150**

(58) **Field of Classification Search** D14/130,
D14/137, 140, 140.1, 140.8, 141.1, 141.3,
D14/142, 147, 149-151, 158-159, 168, 171-172,
D14/188, 211, 214, 225-226, 240, 243, 251,
D14/253, 299, 434; 379/387.01, 388.02,
379/420.02, 447, 453; 381/16; D13/107-108;
191/12.2 R

See application file for complete search history.

(56) **References Cited**

U.S. PATENT DOCUMENTS

- D238,079 S * 12/1975 Herlbertson D14/147
- 4,178,488 A * 12/1979 Nishihata 379/420.02
- D257,841 S * 1/1981 Tada D14/138
- D273,490 S * 4/1984 Chen D14/147
- D275,392 S * 9/1984 Breger D14/147
- D280,403 S * 9/1985 Mitchell D14/147

- D285,681 S * 9/1986 Nakashima D14/159
- D297,732 S * 9/1988 Chan D14/149
- D315,732 S * 3/1991 Shimasaki D14/171
- D420,361 S * 2/2000 Lutz et al. D14/242
- D437,839 S * 2/2001 Eddington et al. D14/150
- D526,639 S * 8/2006 Huang D14/147
- D527,720 S * 9/2006 Huang D14/147

* cited by examiner

Primary Examiner—Ian Simmons

Assistant Examiner—Carla Wright

(74) *Attorney, Agent, or Firm*—Bacon & Thomas, PLLC.

(57) **CLAIM**

The ornamental design for an internet phone, as shown and described.

DESCRIPTION

FIG. 1 is a perspective view of an internet phone in accordance with my design;

FIG. 2 is a front view thereof;

FIG. 3 is a rear view thereof;

FIG. 4 is a left view thereof;

FIG. 5 is a right view thereof;

FIG. 6 is a top view thereof; and,

FIG. 7 is a bottom view thereof.

1 Claim, 3 Drawing Sheets

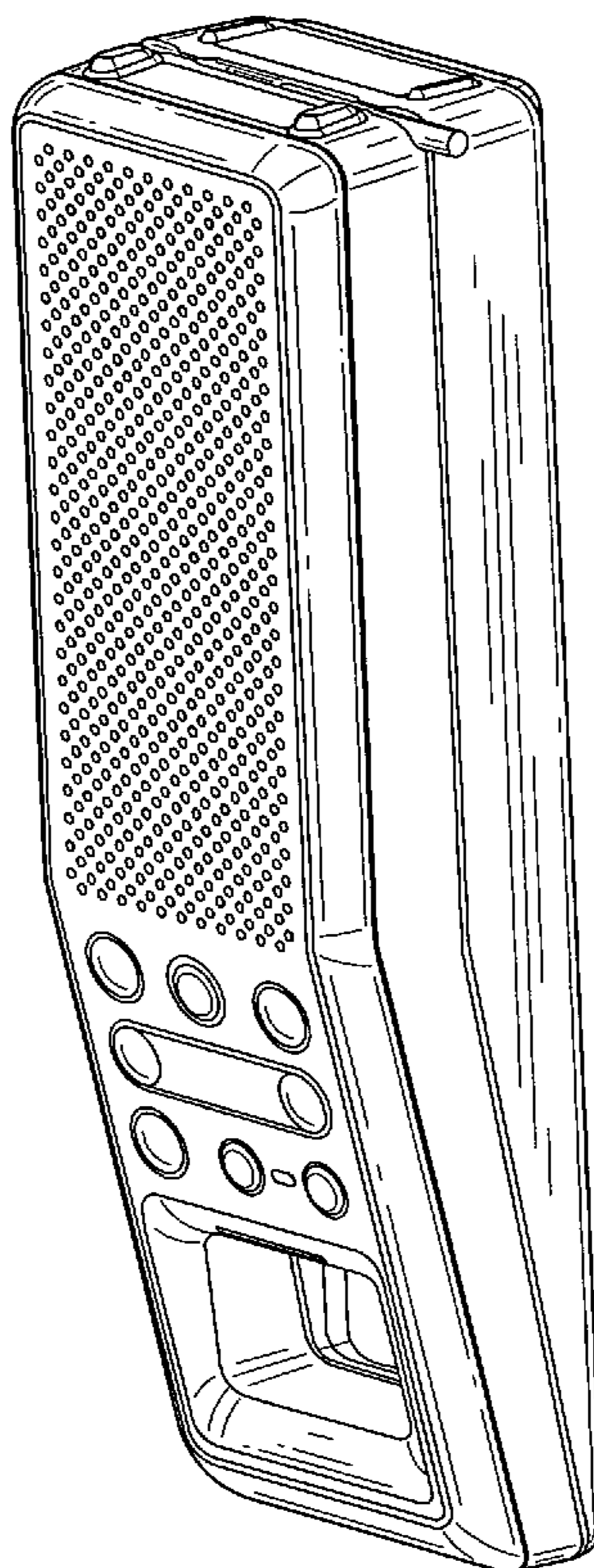

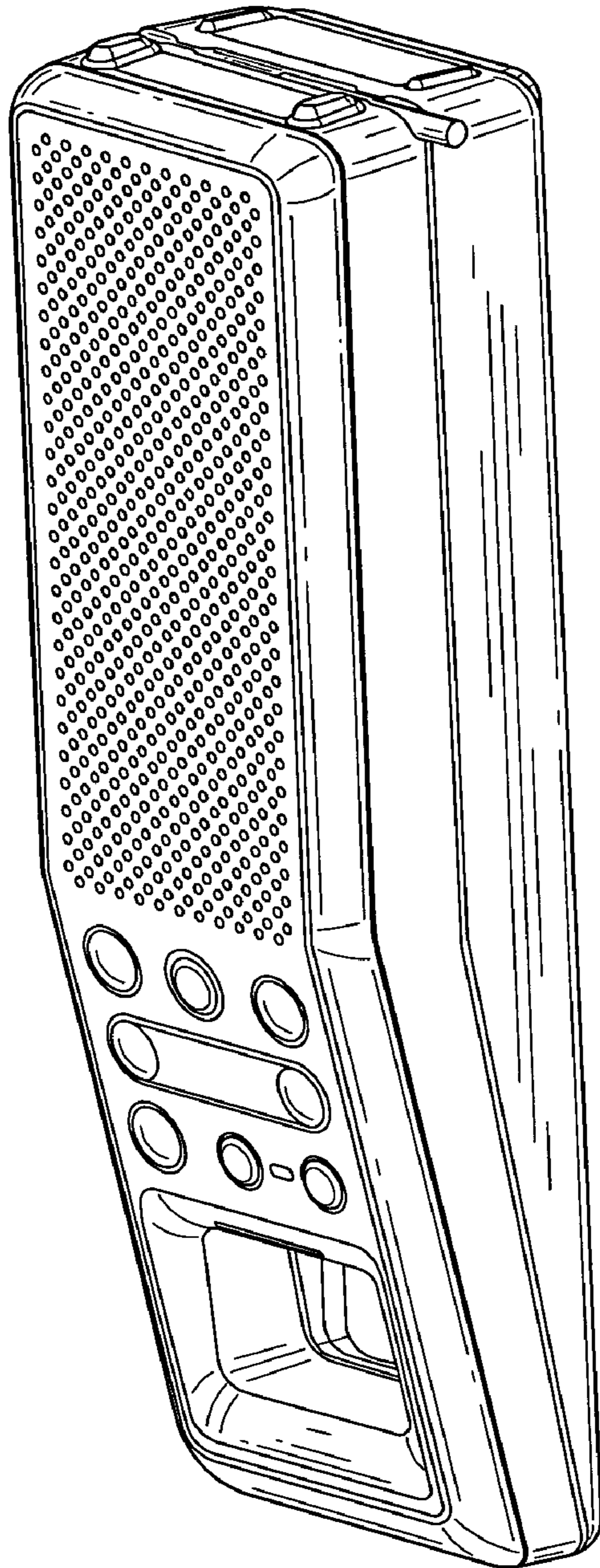

FIG. 1

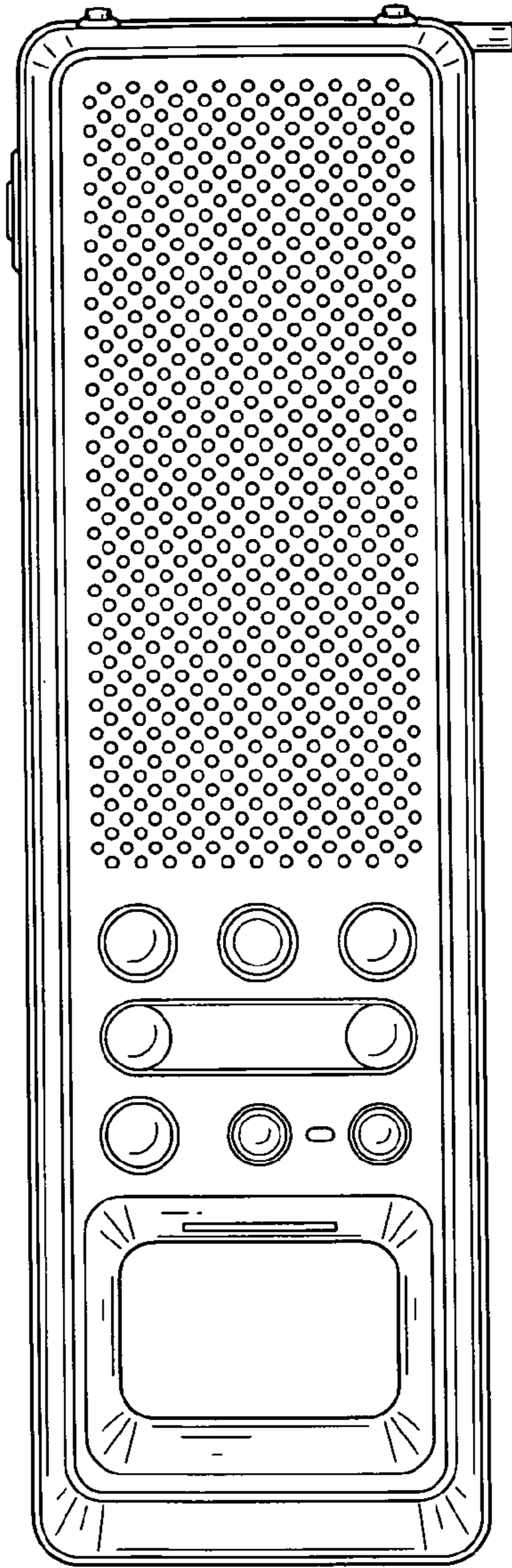

FIG. 2

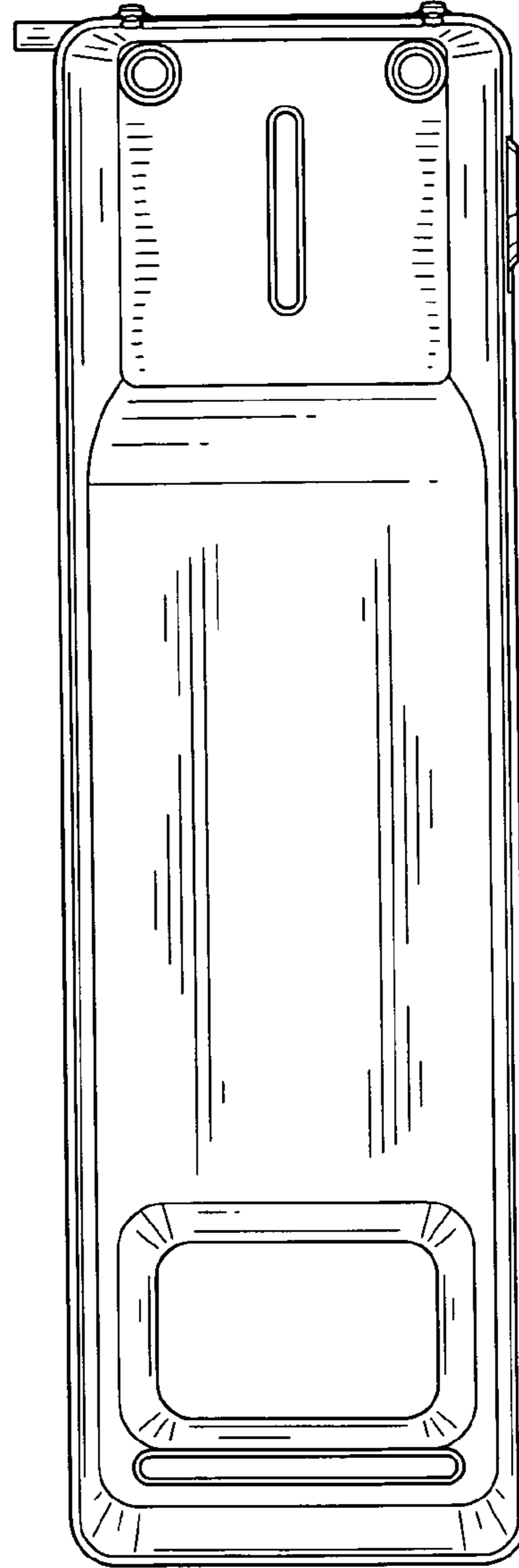

FIG. 3

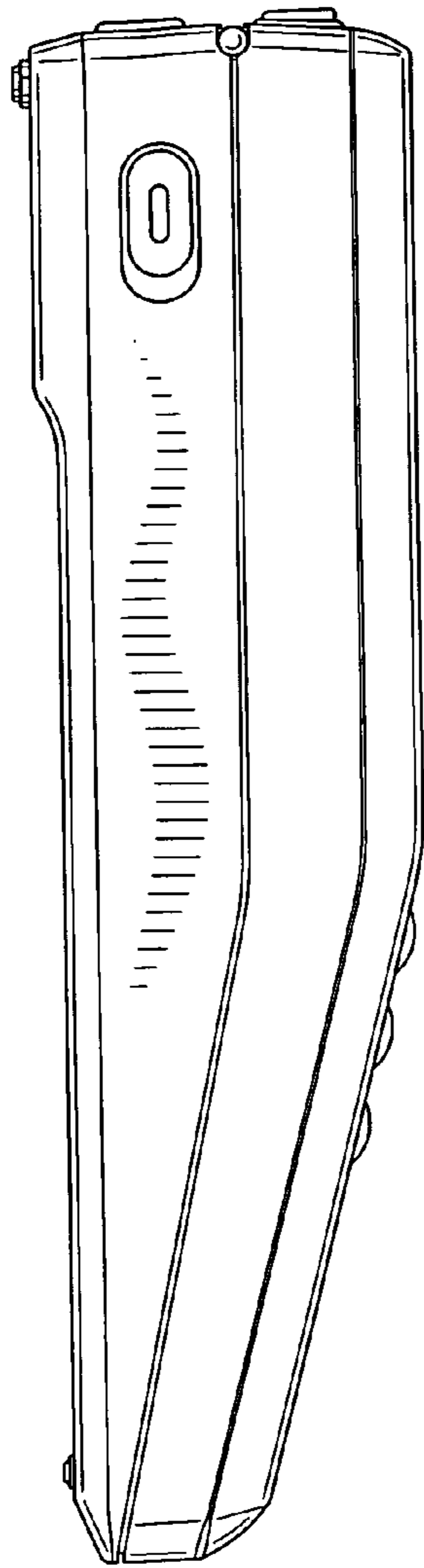

FIG. 4

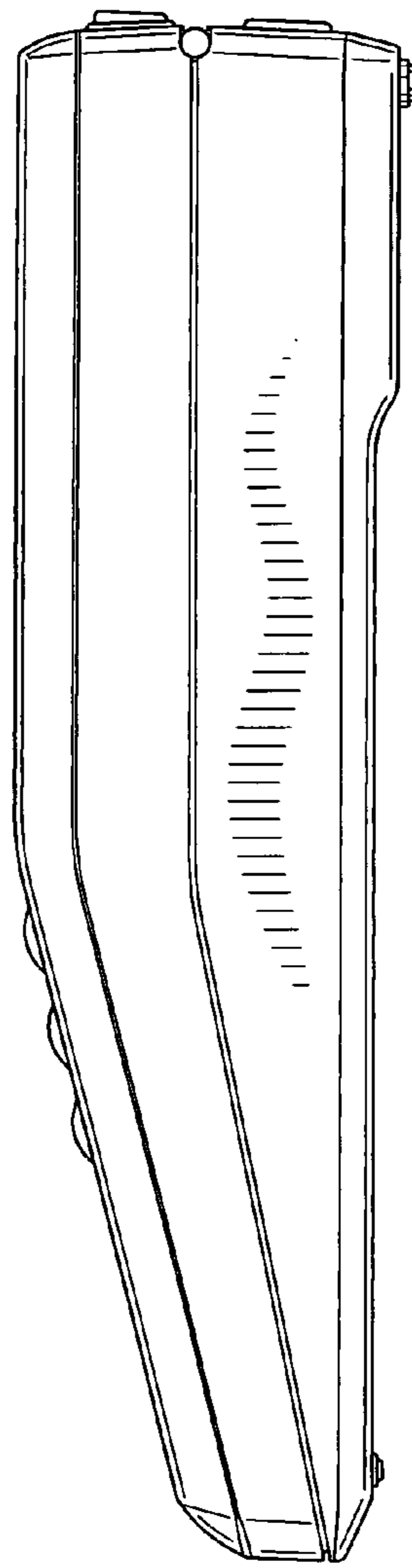

FIG. 5

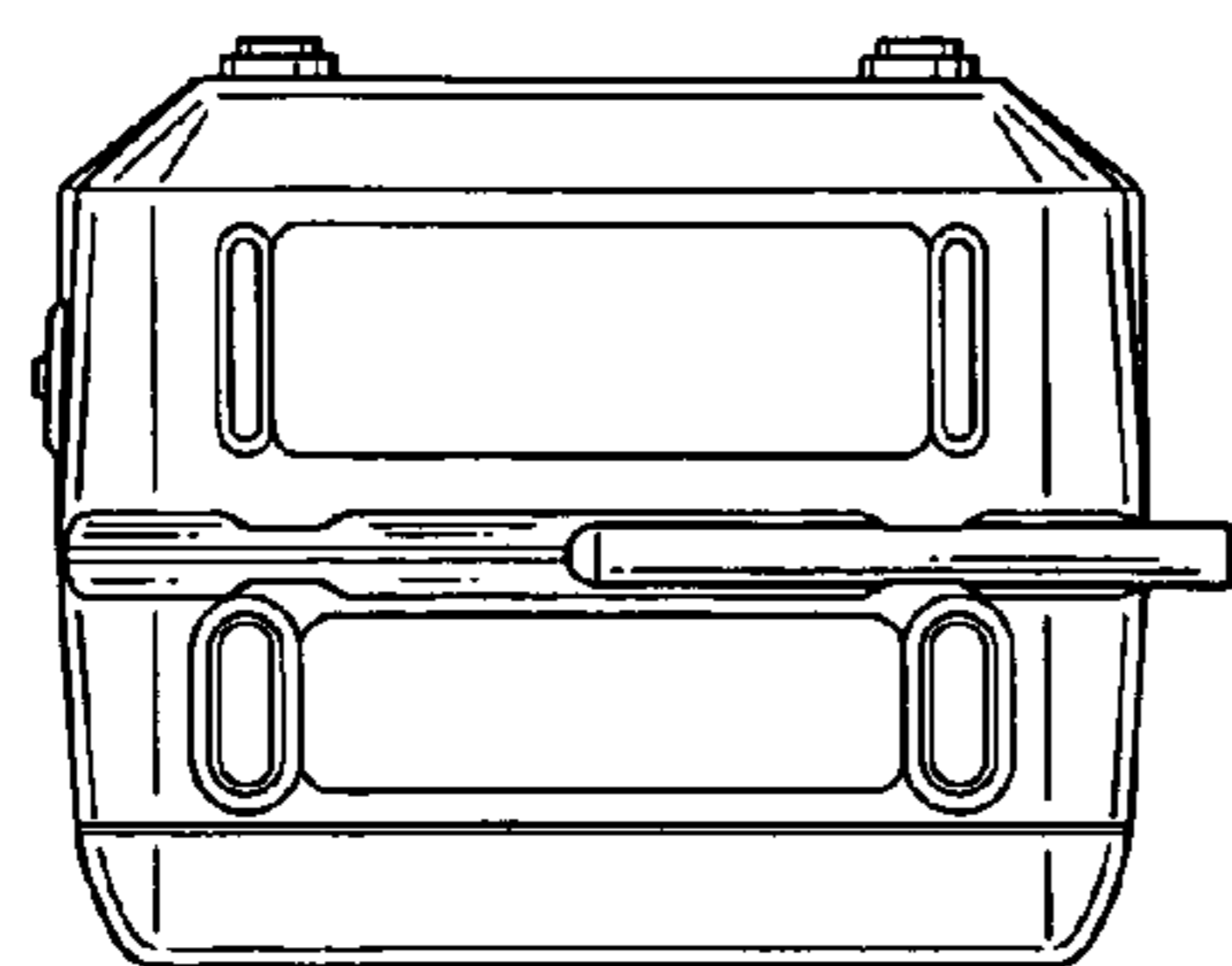

FIG. 6

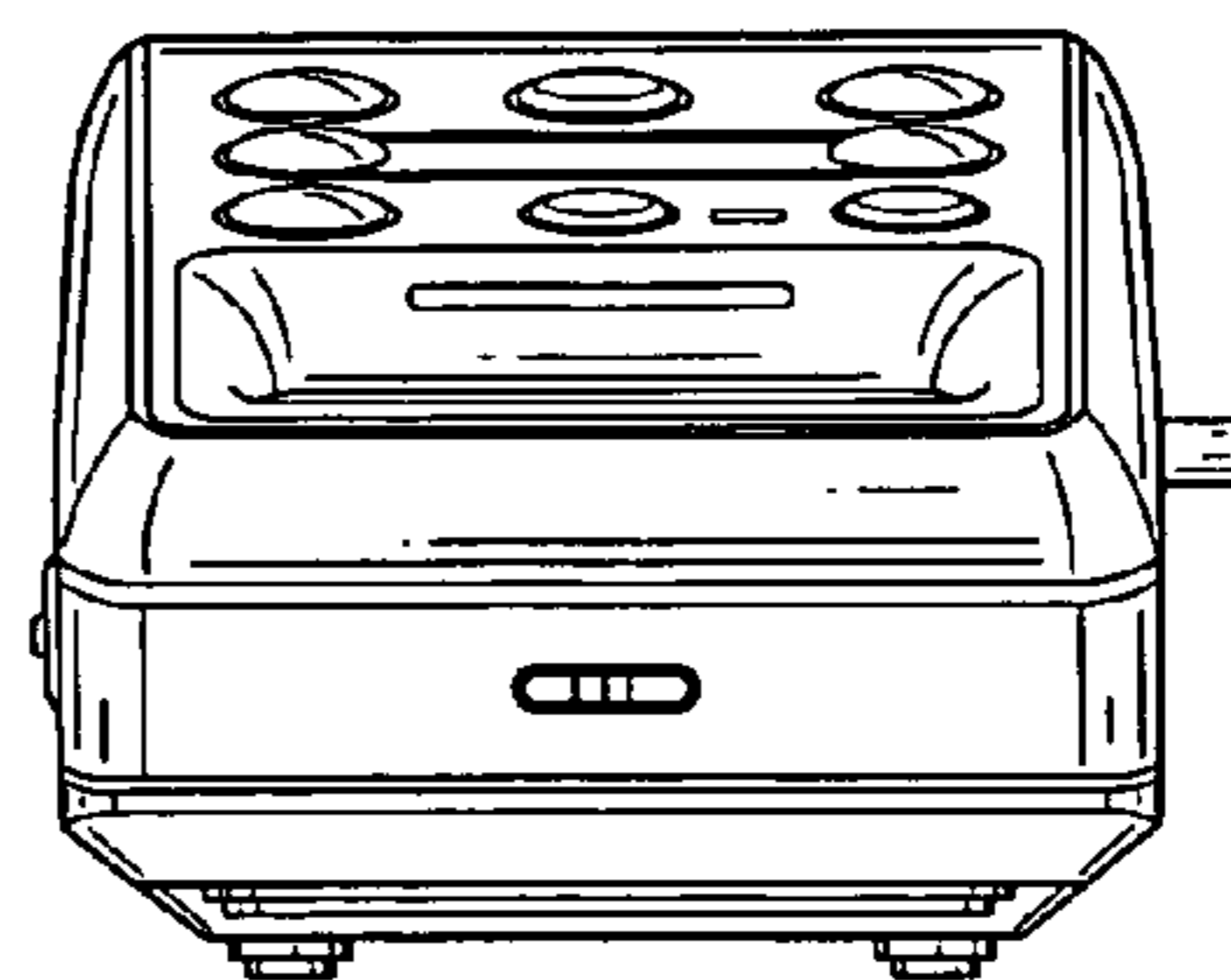

FIG. 7