



US00D570298S

(12) **United States Design Patent**
Hewson et al.

(10) **Patent No.:** **US D570,298 S**
(45) **Date of Patent:** **** Jun. 3, 2008**

(54) **TABLETOP LAMP DIMMER SWITCH**

(75) Inventors: **John C. Hewson**, Philadelphia, PA
(US); **Noel Mayo**, Philadelphia, PA
(US)

(73) Assignee: **Lutron Electronics Co., Inc.**,
Coopersburg, PA (US)

(**) Term: **14 Years**

(21) Appl. No.: **29/298,065**

(22) Filed: **Nov. 28, 2007**

Related U.S. Application Data

(62) Division of application No. 29/285,447, filed on Mar.
29, 2007, now Pat. No. Des. 560,618.

(51) **LOC (8) Cl.** **13-03**

(52) **U.S. Cl.** **D13/162; D13/171; D13/164**

(58) **Field of Classification Search** D13/125,
D13/158-177, 184, 199; 160/120, 262, 310,
160/331; 174/66; 248/266, 7; 307/112,
307/115, 125, 139, 157, 31; 315/112, 149,
315/194, 159, 291-295, 307, 200 R, 209 R,
315/244

See application file for complete search history.

(56) **References Cited**

U.S. PATENT DOCUMENTS

- D320,786 S 10/1991 Darnell et al.
- D421,246 S 2/2000 Mayo et al.
- D428,855 S 8/2000 Mayo et al.
- D437,834 S 2/2001 Mayo et al.
- D439,220 S 3/2001 Mayo et al.
- D441,723 S 5/2001 Mayo et al.
- D442,558 S 5/2001 Mayo et al.
- D456,783 S 5/2002 Mayo et al.
- D461,782 S 8/2002 Butler et al.
- D509,805 S 9/2005 Spira
- D510,073 S 9/2005 Jacoby et al.
- D510,074 S 9/2005 Larson et al.

- D533,843 S 12/2006 Larson et al.
- D540,267 S 4/2007 Larson et al.
- D540,748 S 4/2007 Larson et al.
- D542,226 S 5/2007 Spira
- D542,227 S 5/2007 Larson et al.
- D542,229 S 5/2007 Larson et al.
- D542,737 S 5/2007 Spira
- D547,731 S 7/2007 Larson et al.

Primary Examiner—Daniel Bui
Assistant Examiner—Thomas J Johannes
(74) *Attorney, Agent, or Firm*—Mark E. Rose; Philip N. Smith

(57) **CLAIM**

We claim the ornamental design for a tabletop lamp dimmer switch, as shown and described.

DESCRIPTION

FIG. 1 is a perspective view of a tabletop lamp dimmer switch according to a first embodiment of our new design.

FIG. 2 is a front view thereof.

FIG. 3 is a left side view thereof.

FIG. 4 is a right side view thereof.

FIG. 5 is a top view thereof.

FIG. 6 is a bottom view thereof.

FIG. 7 is a perspective view of a tabletop lamp dimmer switch according to a second embodiment of our new design.

FIG. 8 is a front view thereof.

FIG. 9 is a left side view thereof.

FIG. 10 is a right side view thereof.

FIG. 11 is a top view thereof; and,

FIG. 12 is a bottom view thereof.

The rear views form no part of the design and are omitted. The portions of the drawings appearing in broken line are for environment only and do not form a part of the design.

1 Claim, 8 Drawing Sheets

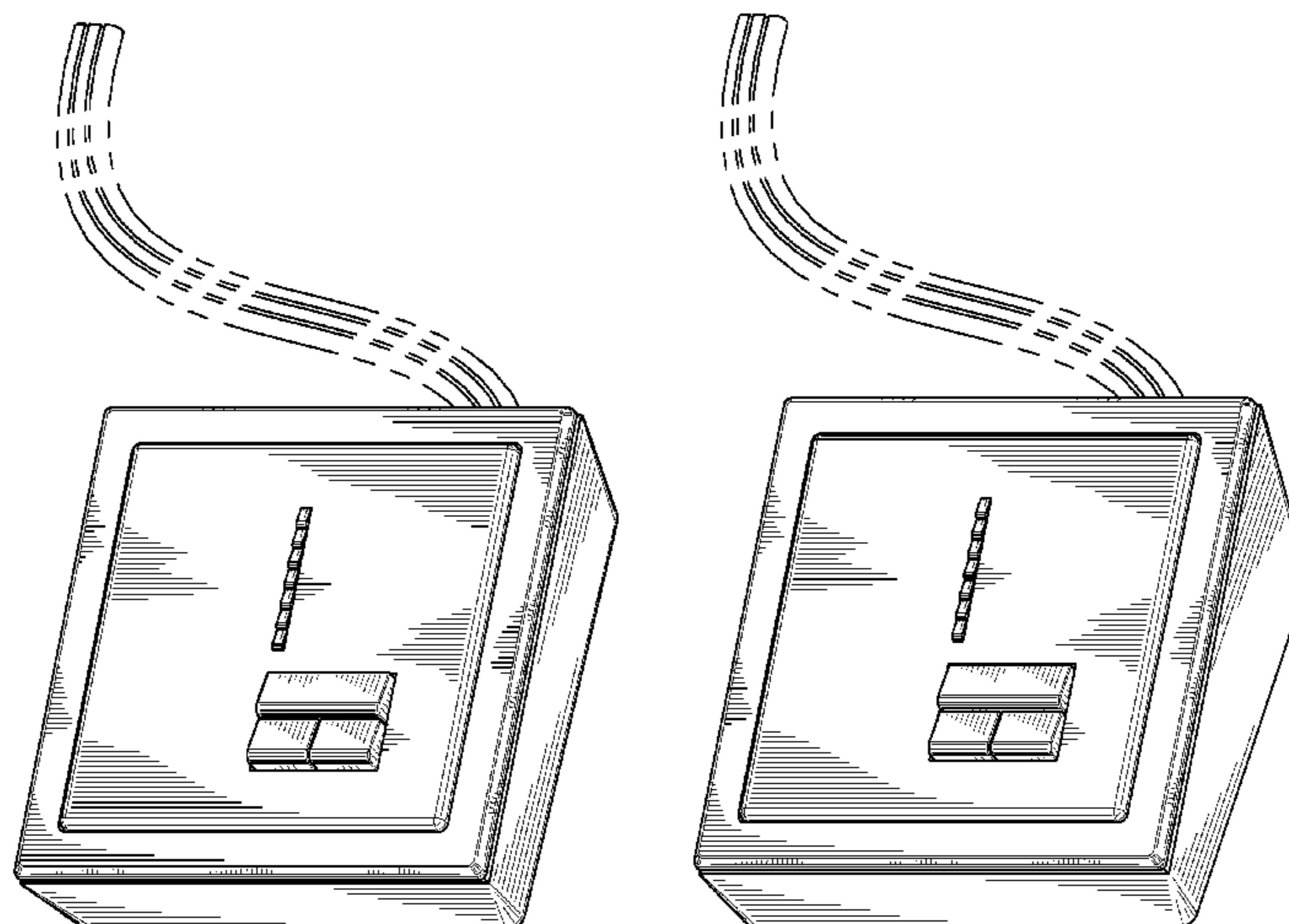

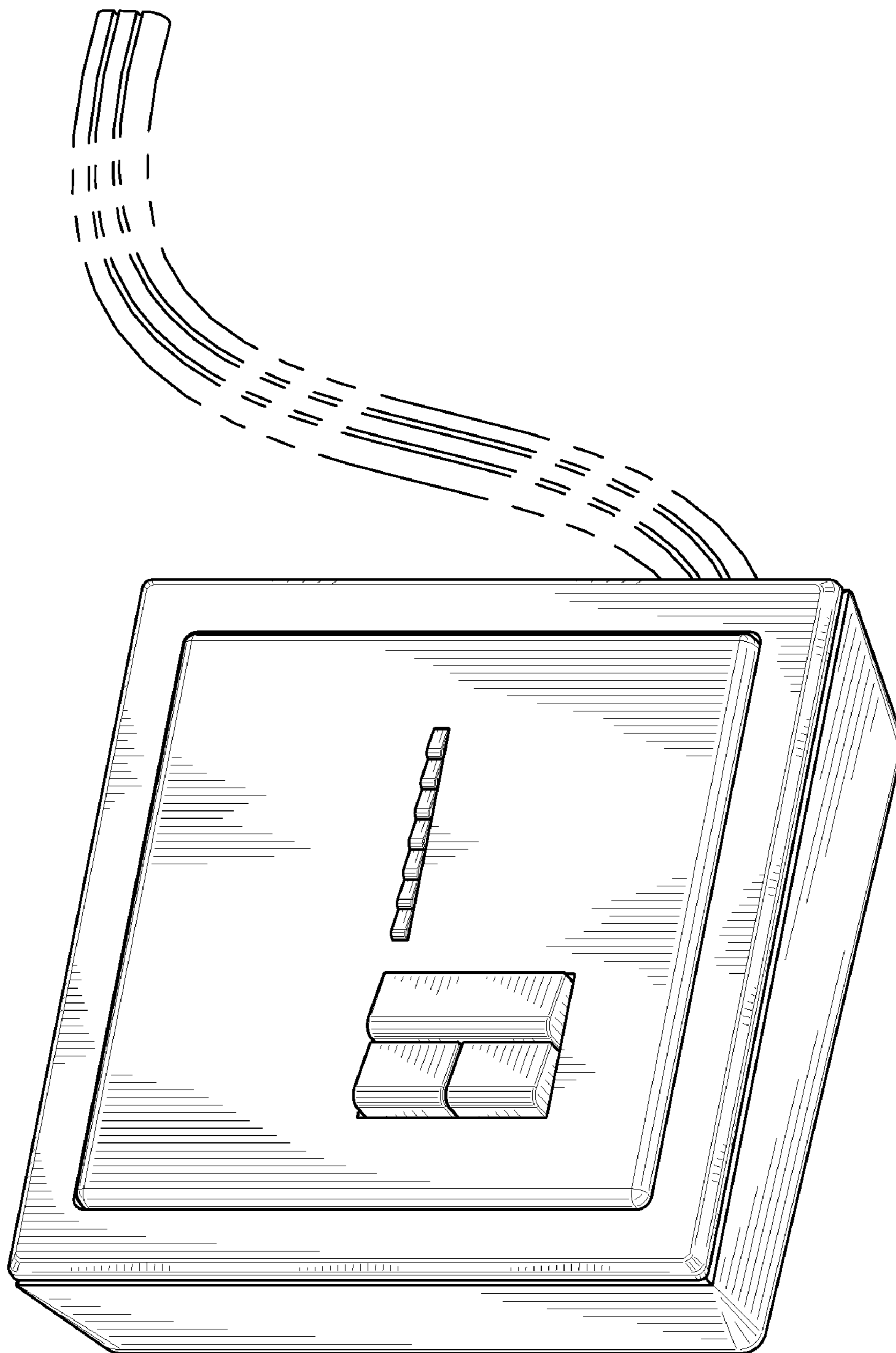

Fig. 1

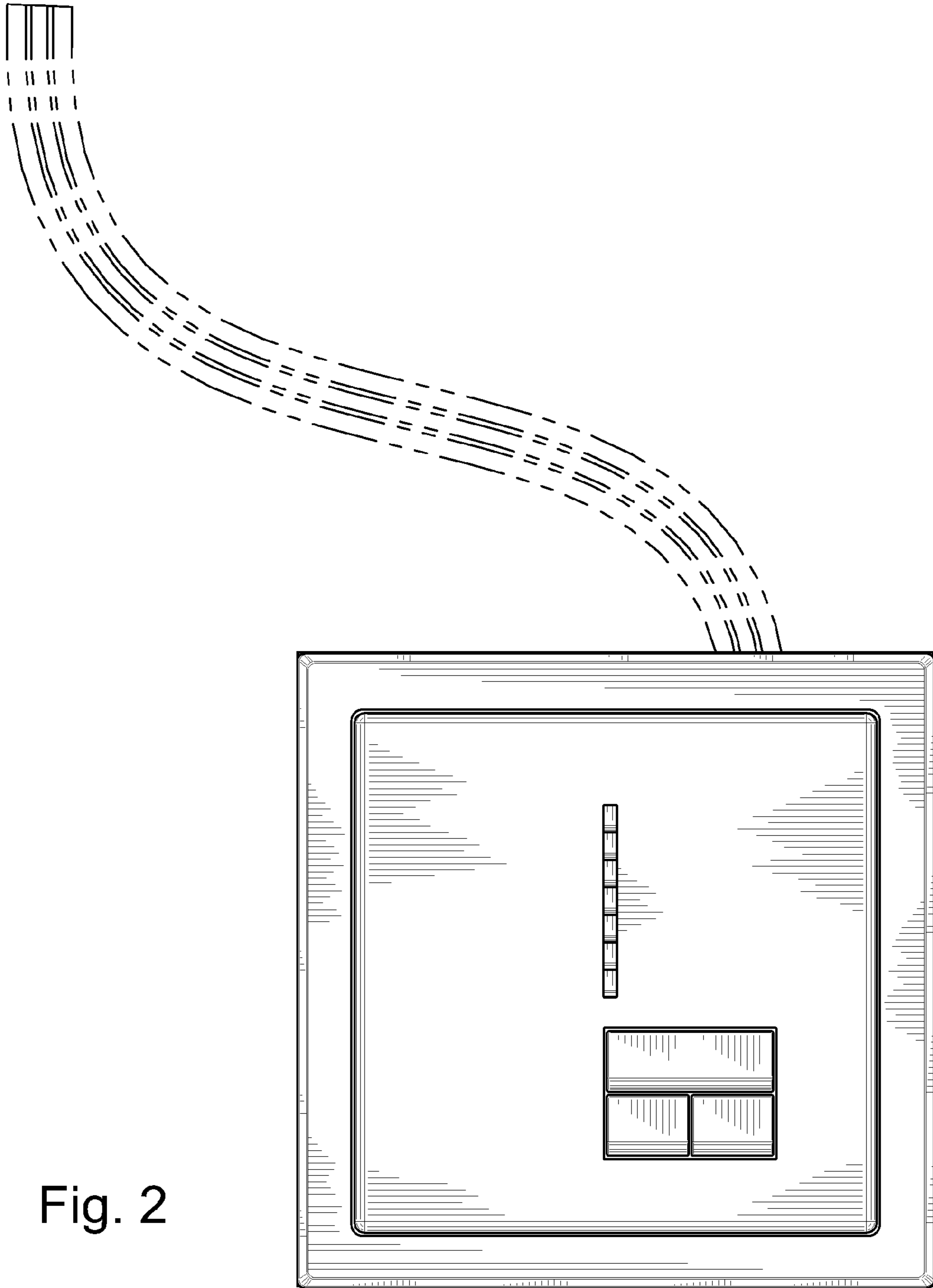

Fig. 2

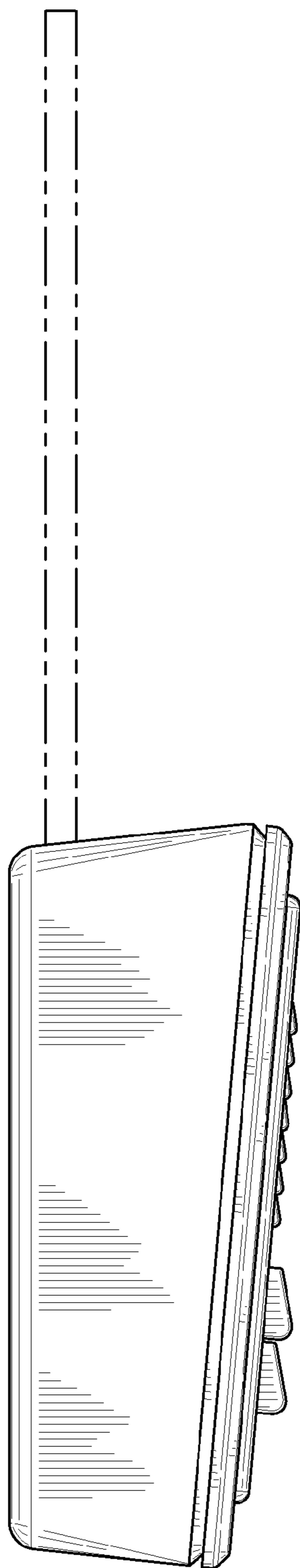

Fig. 3

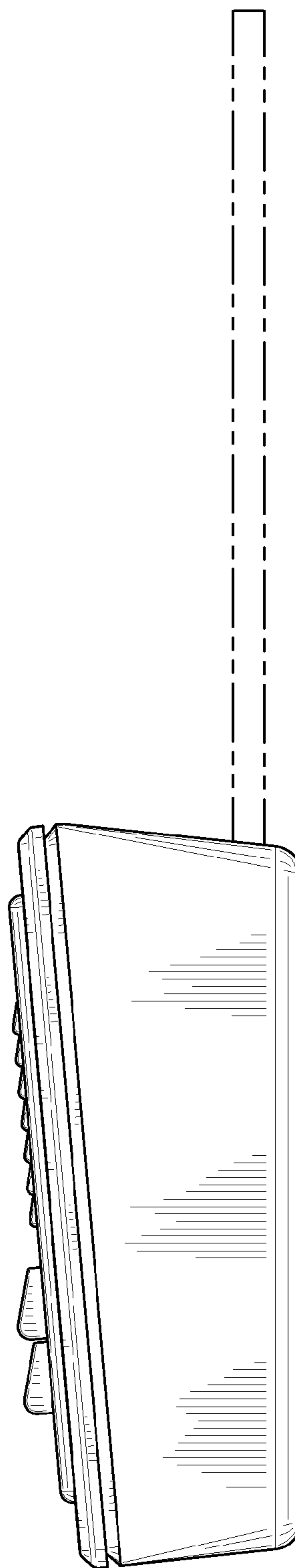

Fig. 4

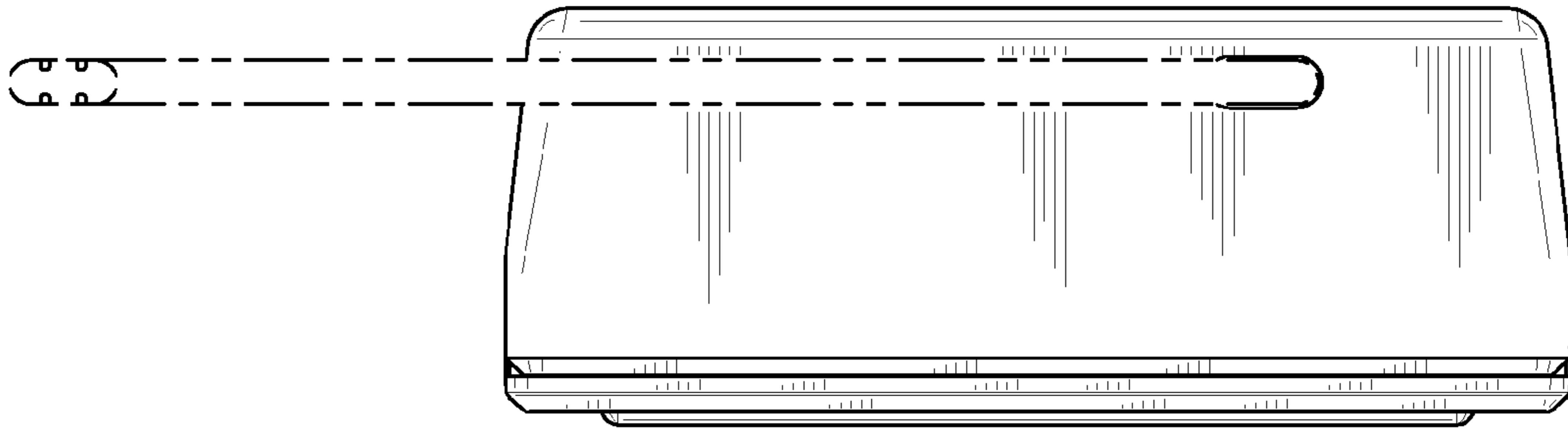

Fig. 5

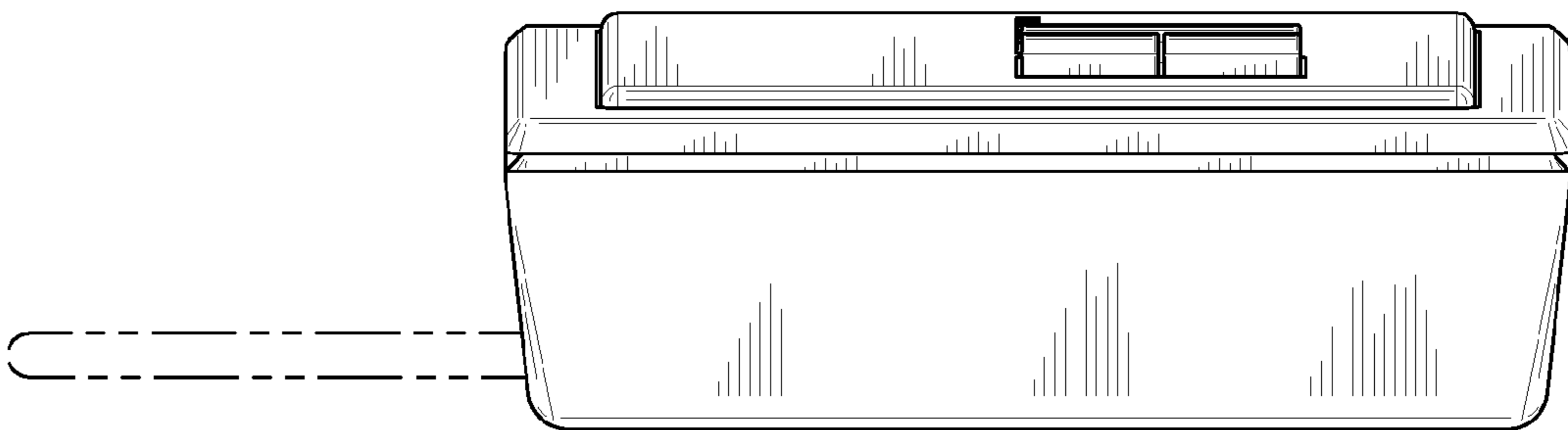

Fig. 6

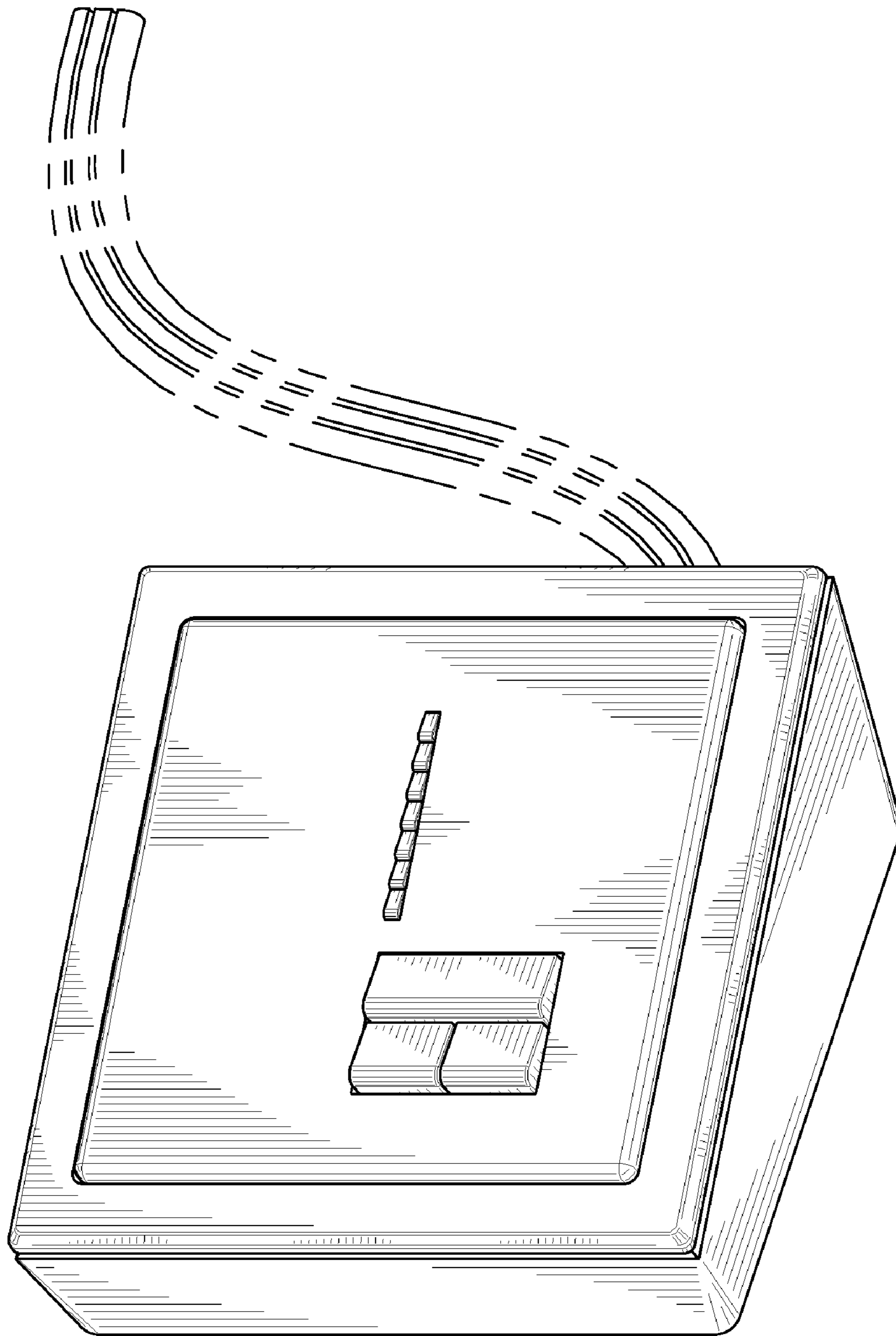

Fig. 7

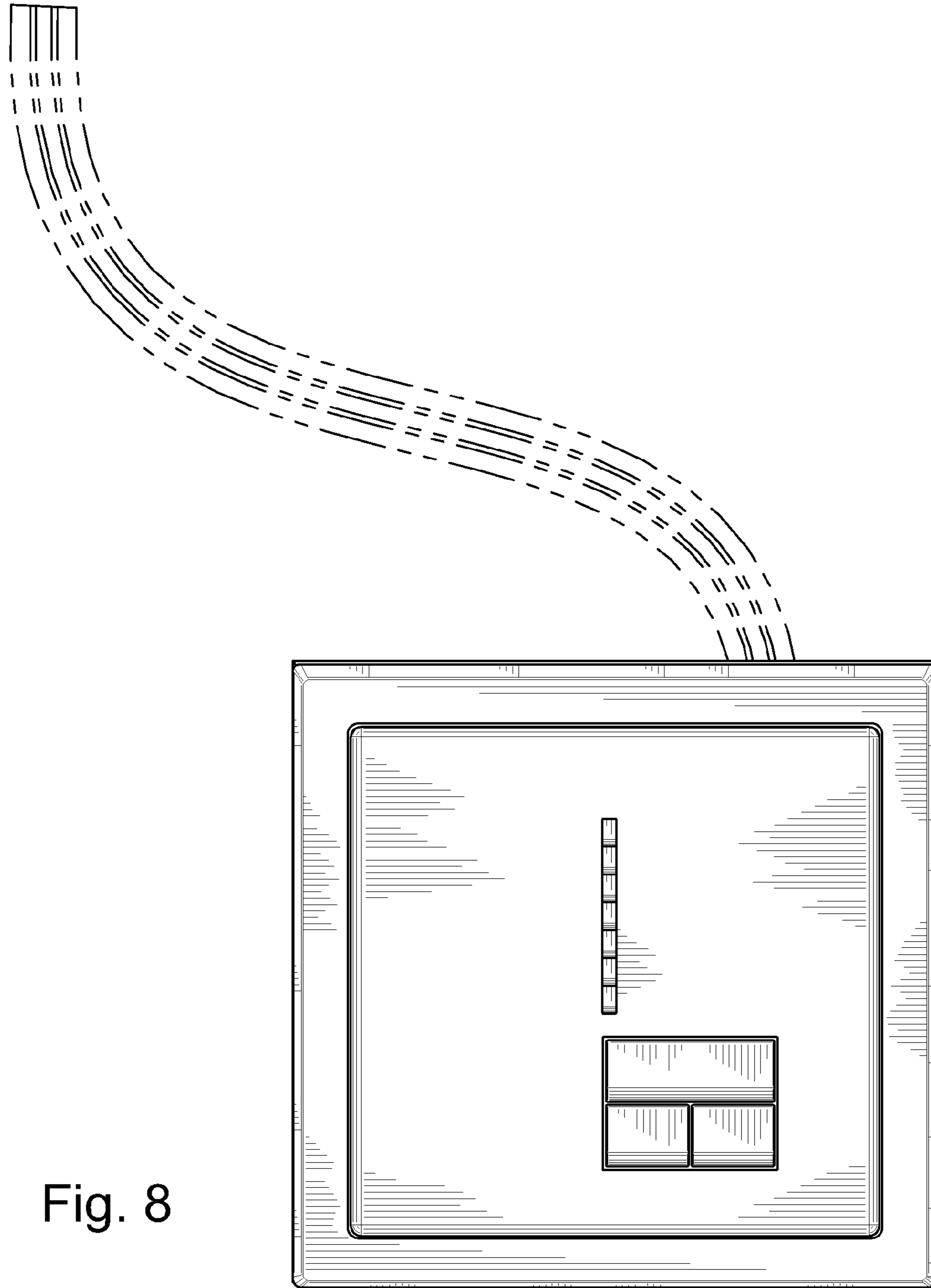

Fig. 8

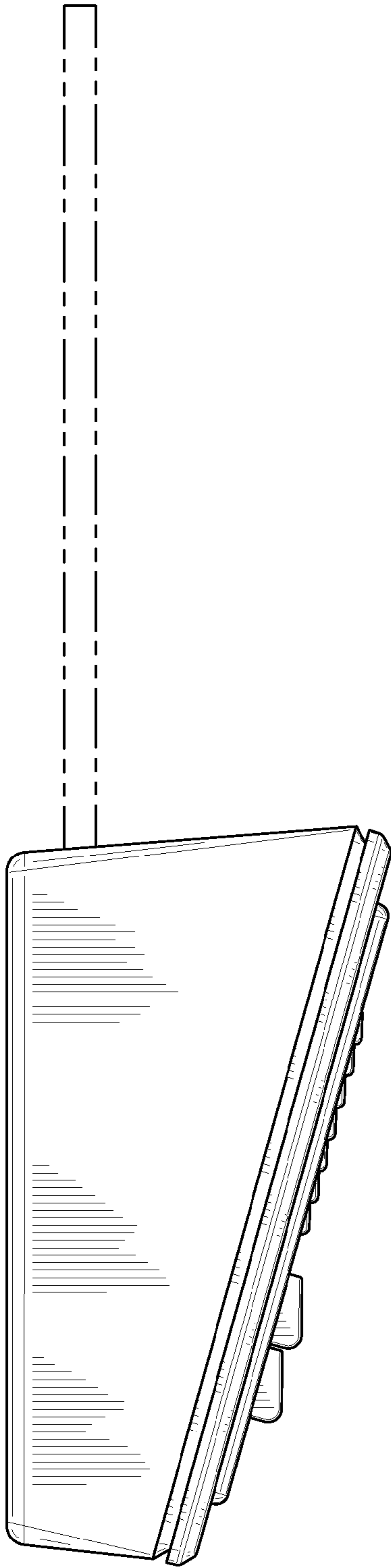

Fig. 9

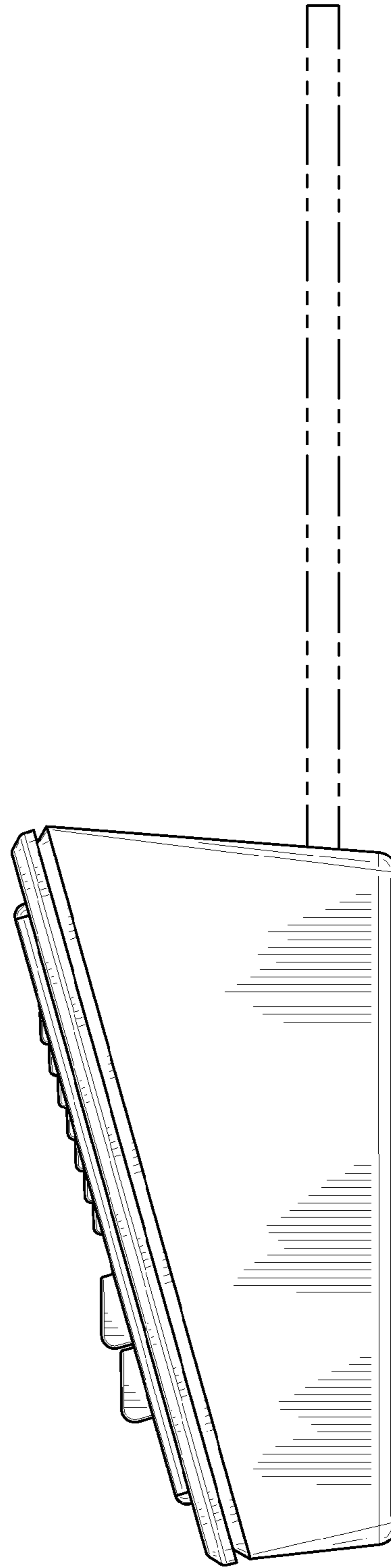

Fig. 10

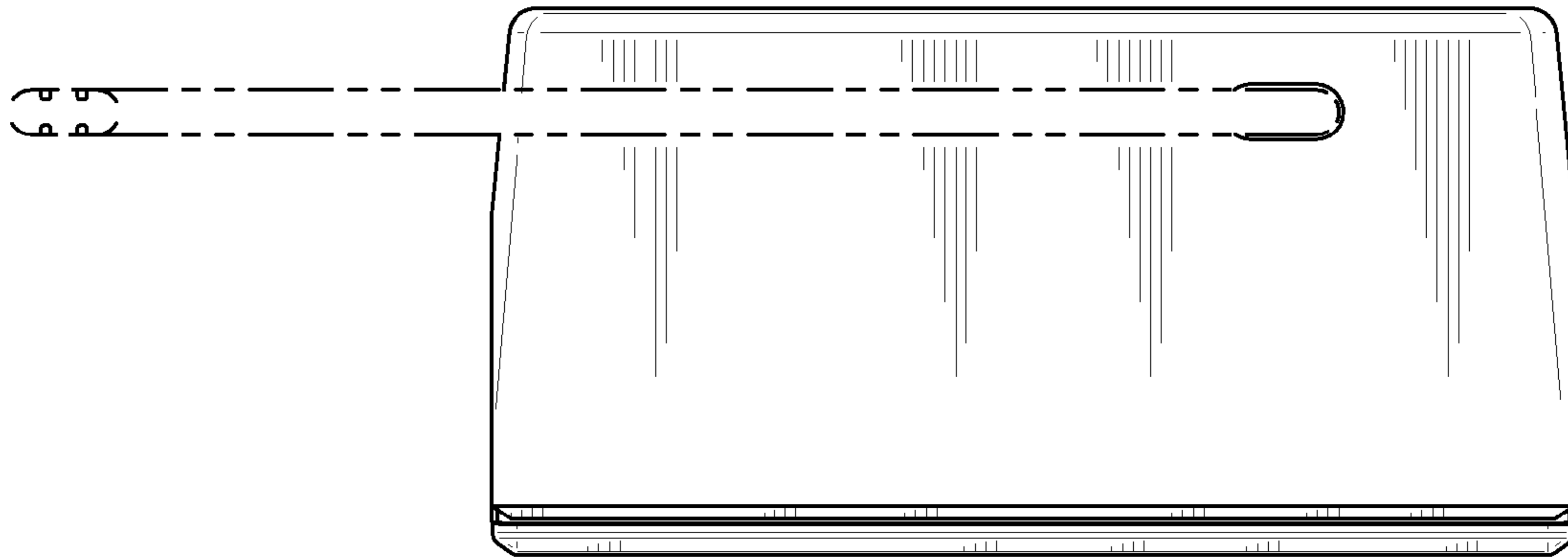

Fig. 11

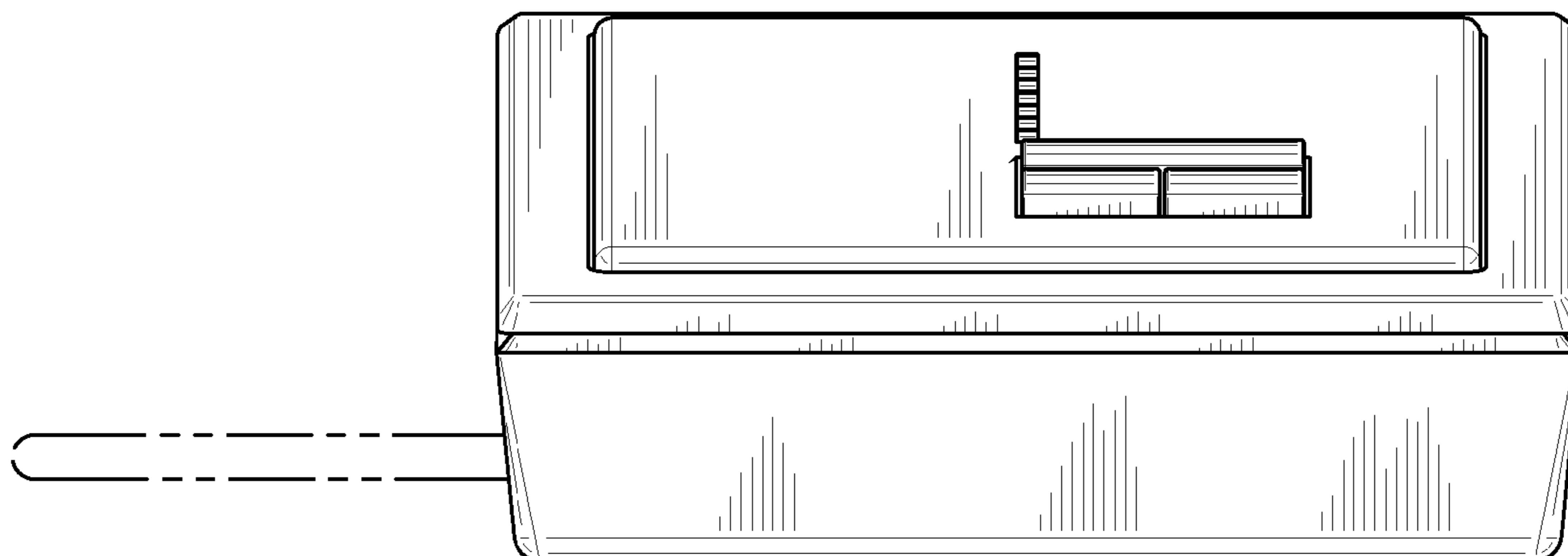

Fig. 12