



US00D570240S

(12) **United States Design Patent**
Gruosi-Scheufele

(10) **Patent No.:** **US D570,240 S**

(45) **Date of Patent:** **** Jun. 3, 2008**

(54) **PENDANT**

D428,354 S * 7/2000 Olofsson D11/40

D550,582 S * 9/2007 Gruosi-Scheufele D11/43

D552,503 S * 10/2007 Olsen D11/61

(75) Inventor: **Caroline Gruosi-Scheufele**, Prangins
(CH)

(73) Assignee: **Chopard International SA**, Prangins
(CH)

* cited by examiner

Primary Examiner—R. Seifert

(74) *Attorney, Agent, or Firm*—McGlew and Tuttle P.C.

(**) Term: **14 Years**

(21) Appl. No.: **29/295,717**

(57) **CLAIM**

(22) Filed: **Oct. 4, 2007**

The ornamental design for a pendant, as shown and described.

(30) **Foreign Application Priority Data**

Apr. 10, 2007 (WO) DM/068 850

DESCRIPTION

(51) **LOC (8) Cl.** **11-01**

(52) **U.S. Cl.** **D11/79**

(58) **Field of Classification Search** D11/1-2,
D11/40-41, 43-50, 53, 56, 60, 63, 65, 67,
D11/75-781; 63/1.11, 1.12, 1.13, 1.14, 1.16,
63/1.18, 13, 14.1, 35, 38, 39

See application file for complete search history.

FIG. 1 is a left side view of my new pendant design;

FIG. 2 is a front view thereof;

FIG. 3 is a right side view thereof;

FIG. 4 is a top view thereof;

FIG. 5 is a rear view thereof;

FIG. 6 is a bottom view thereof; and,

FIG. 7 is a perspective view thereof.

(56) **References Cited**

U.S. PATENT DOCUMENTS

D116,324 S * 8/1939 Lampl D11/81

1 Claim, 1 Drawing Sheet

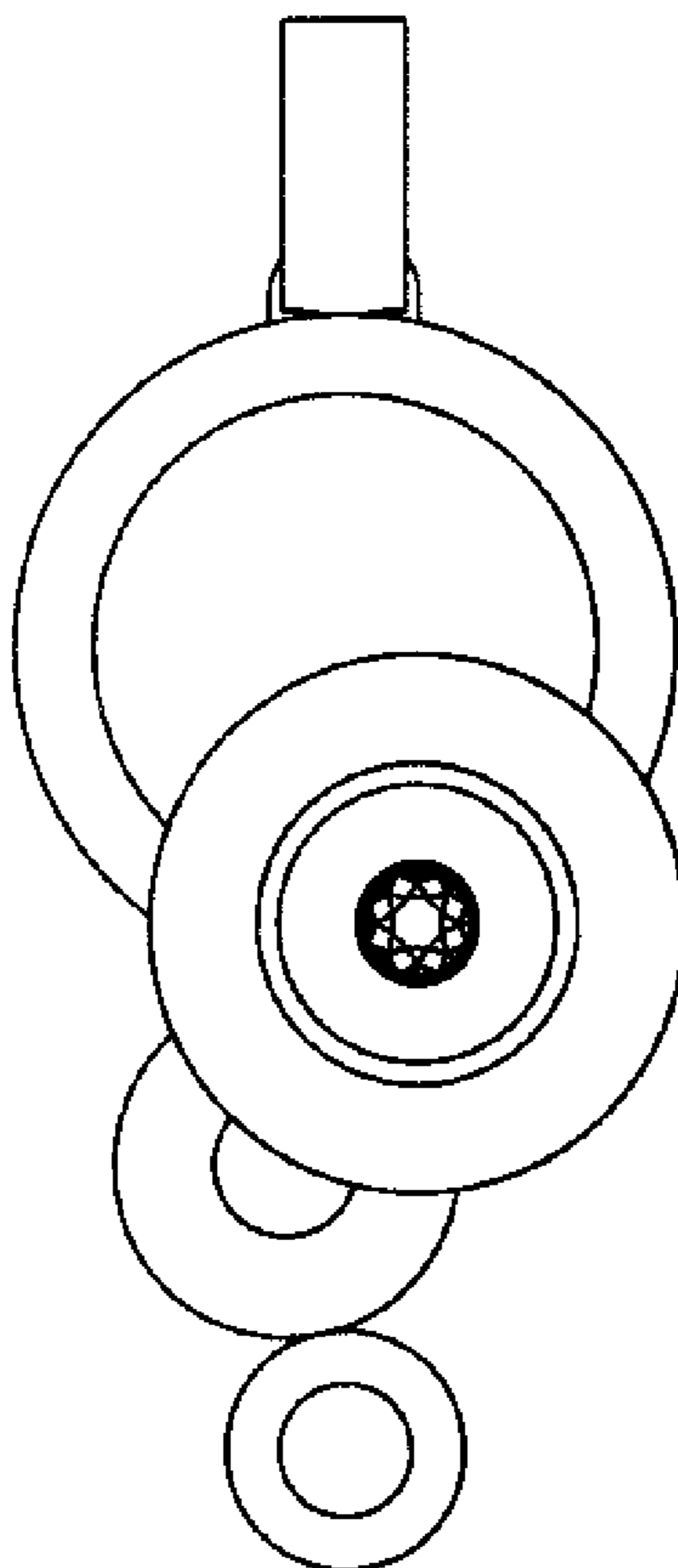

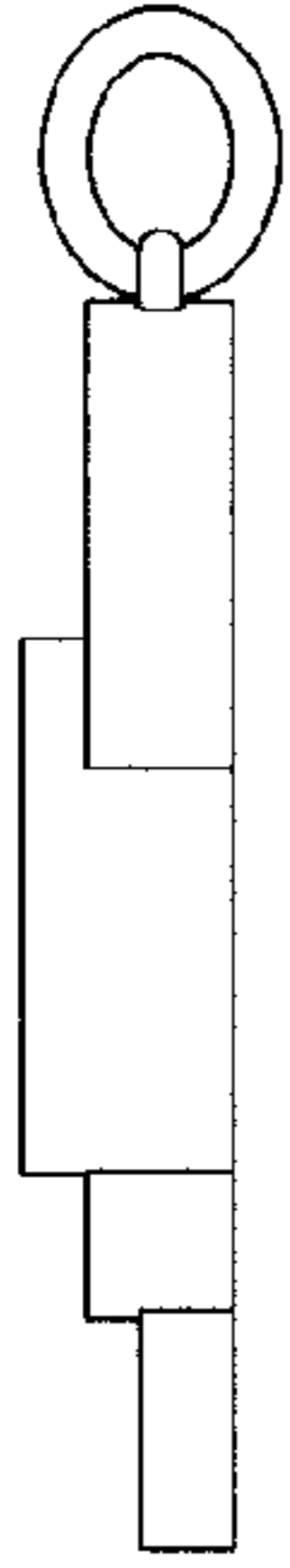

Fig. 1

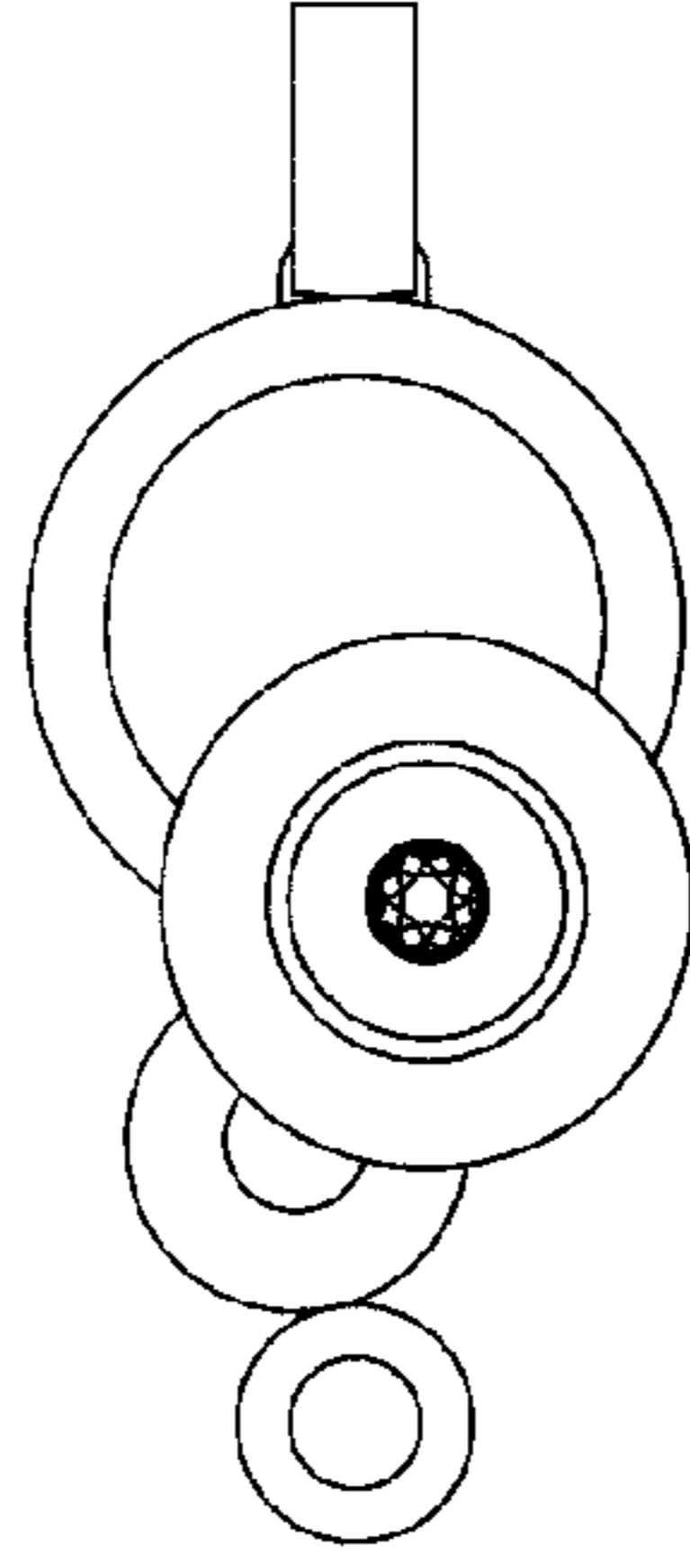

Fig. 2

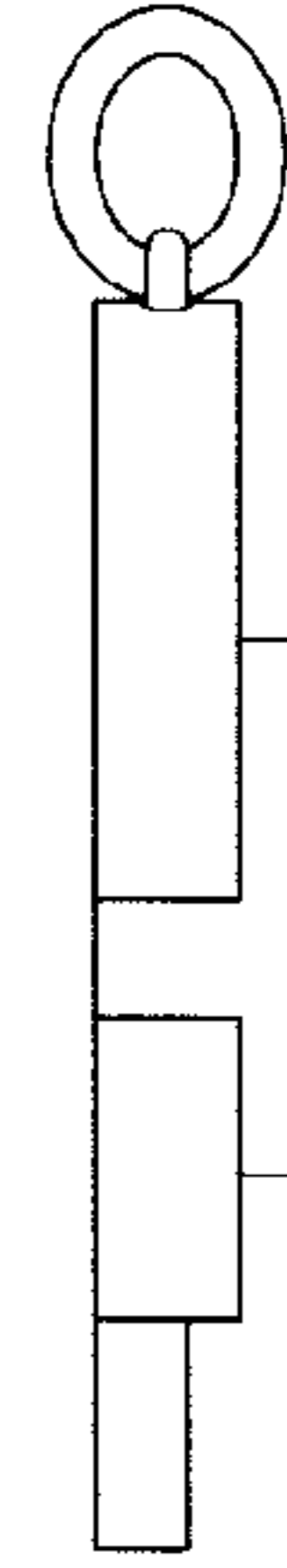

Fig. 3

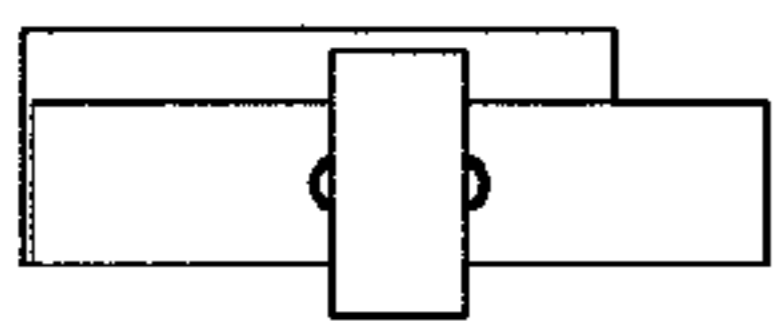

Fig. 4

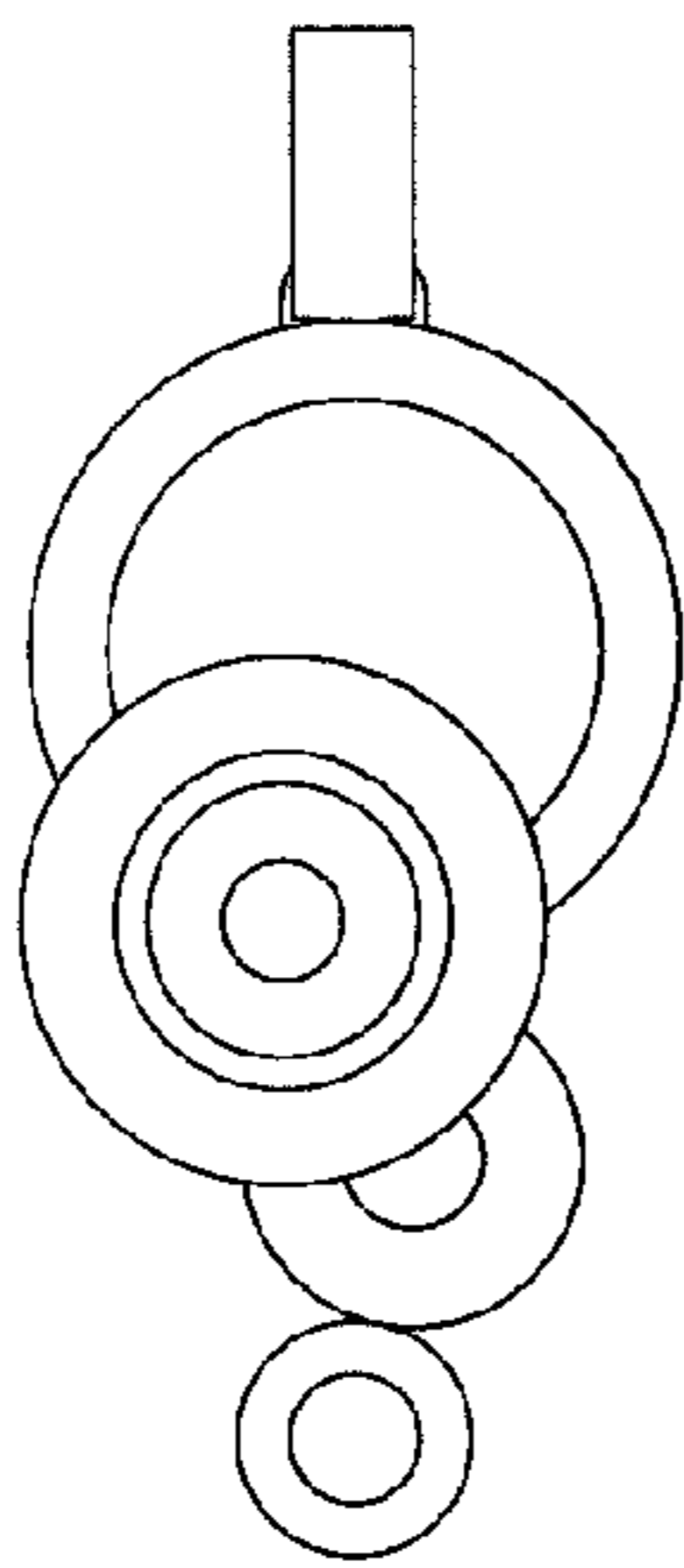

Fig. 5



Fig. 6

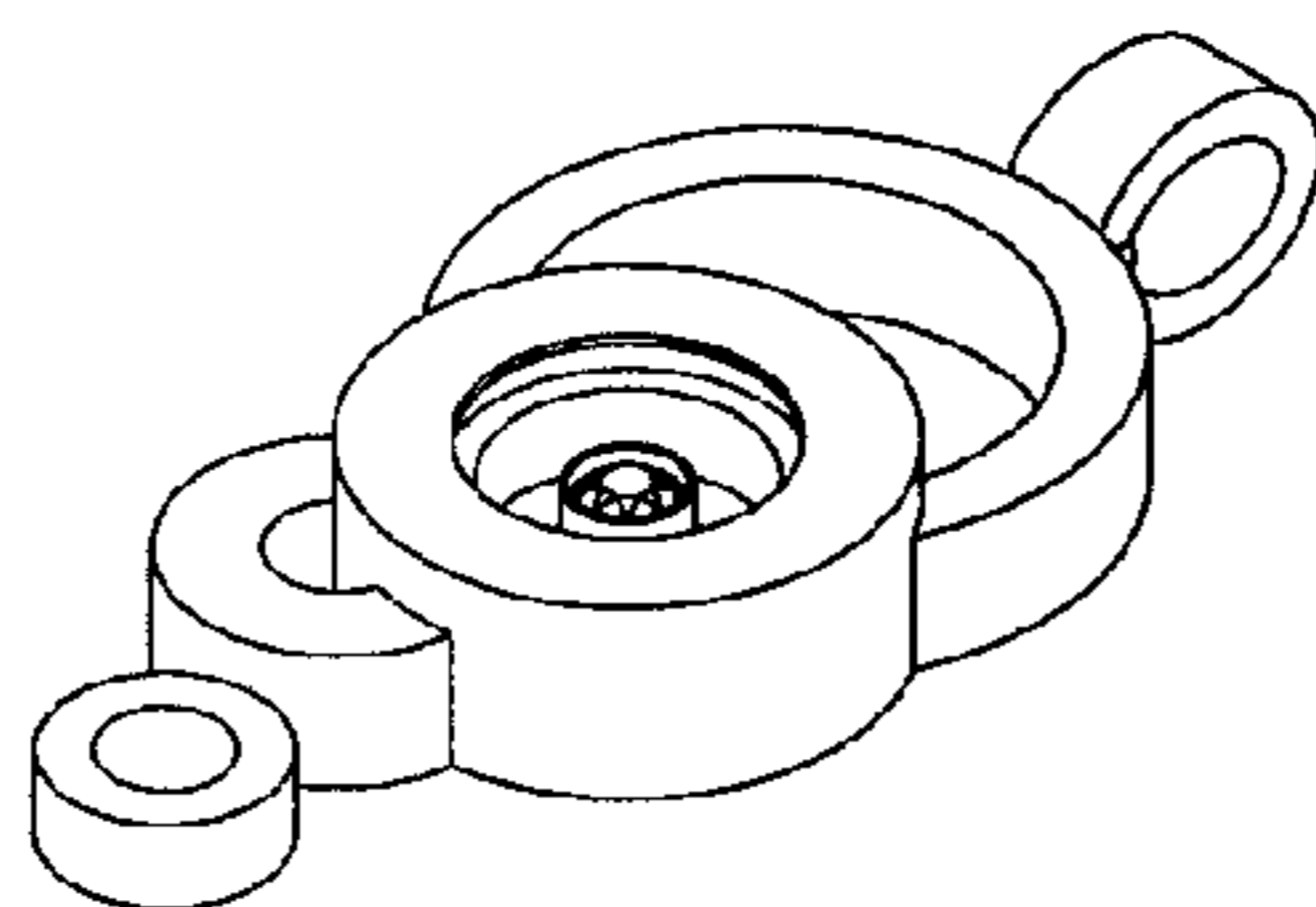

Fig. 7