



US00D570207S

(12) **United States Design Patent**
Cox et al.

(10) **Patent No.:** **US D570,207 S**
(45) **Date of Patent:** **** Jun. 3, 2008**

(54) **CONDUIT GUIDE CLIP**

FOREIGN PATENT DOCUMENTS

(75) Inventors: **Marvin Cox**, Wichita, KS (US);
Anthony F. Beugelsdyk, Wichita, KS (US)

GB 888450 1/1962

(73) Assignee: **Wescon Products Company**, Wichita, KS (US)

OTHER PUBLICATIONS

Wescon Products Company binder—1978 (11 pages).

(**) Term: **14 Years**

Primary Examiner—Robert M. Spear

Assistant Examiner—John Windmuller

(21) Appl. No.: **29/279,157**

(74) *Attorney, Agent, or Firm*—Hovey Williams LLP

(22) Filed: **Apr. 20, 2007**

(57) **CLAIM**

The ornamental design for a conduit guide clip, as shown and described.

(51) **LOC (8) Cl.** **08-08**

(52) **U.S. Cl.** **D8/396**

(58) **Field of Classification Search** D8/356,
D8/371, 394–396, 354, 355; 24/19 R, 279,
24/336, 339, 229, 536; 248/49, 62, 74.1–74.4,
248/73, 229, 681; 403/397, 399, 409.1
See application file for complete search history.

DESCRIPTION

FIG. 1 is a right, rear, bottom perspective view showing a conduit guide clip in accordance with the present invention; FIG. 2 is a left, top, front perspective view thereof; FIG. 3 is a bottom view thereof; FIG. 4 is a top plan view thereof; FIG. 5 is a left side elevational view thereof; FIG. 6 is a right side elevational view thereof; FIG. 7 is a rear view thereof; FIG. 8 is a front view thereof; FIG. 9 is a right rear bottom perspective view of an alternate embodiment of our conduit guide clip configured as a mirror image of the conduit guide clip shown in FIG. 1 and adapted for mounting on an opposite side of a tubular support; FIG. 10 is a left, top, front perspective view thereof; FIG. 11 is a bottom view thereof; FIG. 12 is a top plan view thereof; FIG. 13 is a left side elevational view thereof; FIG. 14 is a right side elevational view thereof; FIG. 15 is a rear view thereof, and, FIG. 16 is a front view thereof.

(56) **References Cited**

U.S. PATENT DOCUMENTS

639,337 A	12/1899	Anthony	
1,296,042 A	3/1919	Bralove	
2,655,703 A	10/1953	Flora	
3,491,971 A	1/1970	Fisher	
3,540,091 A *	11/1970	Marosy	24/573.11
3,995,512 A	12/1976	Johnsen	
4,011,770 A	3/1977	Webb	
4,386,752 A	6/1983	Pavlak et al.	
4,461,189 A	7/1984	Rottenkolber et al.	
4,647,241 A	3/1987	Weber	
D298,645 S *	11/1988	Miyata et al.	D22/143
5,016,843 A	5/1991	Ward	
5,172,878 A	12/1992	Lederman	
5,230,257 A	7/1993	Nowak	
5,291,910 A	3/1994	Bui et al.	
D351,552 S *	10/1994	Williams	D8/356

(Continued)

1 Claim, 2 Drawing Sheets

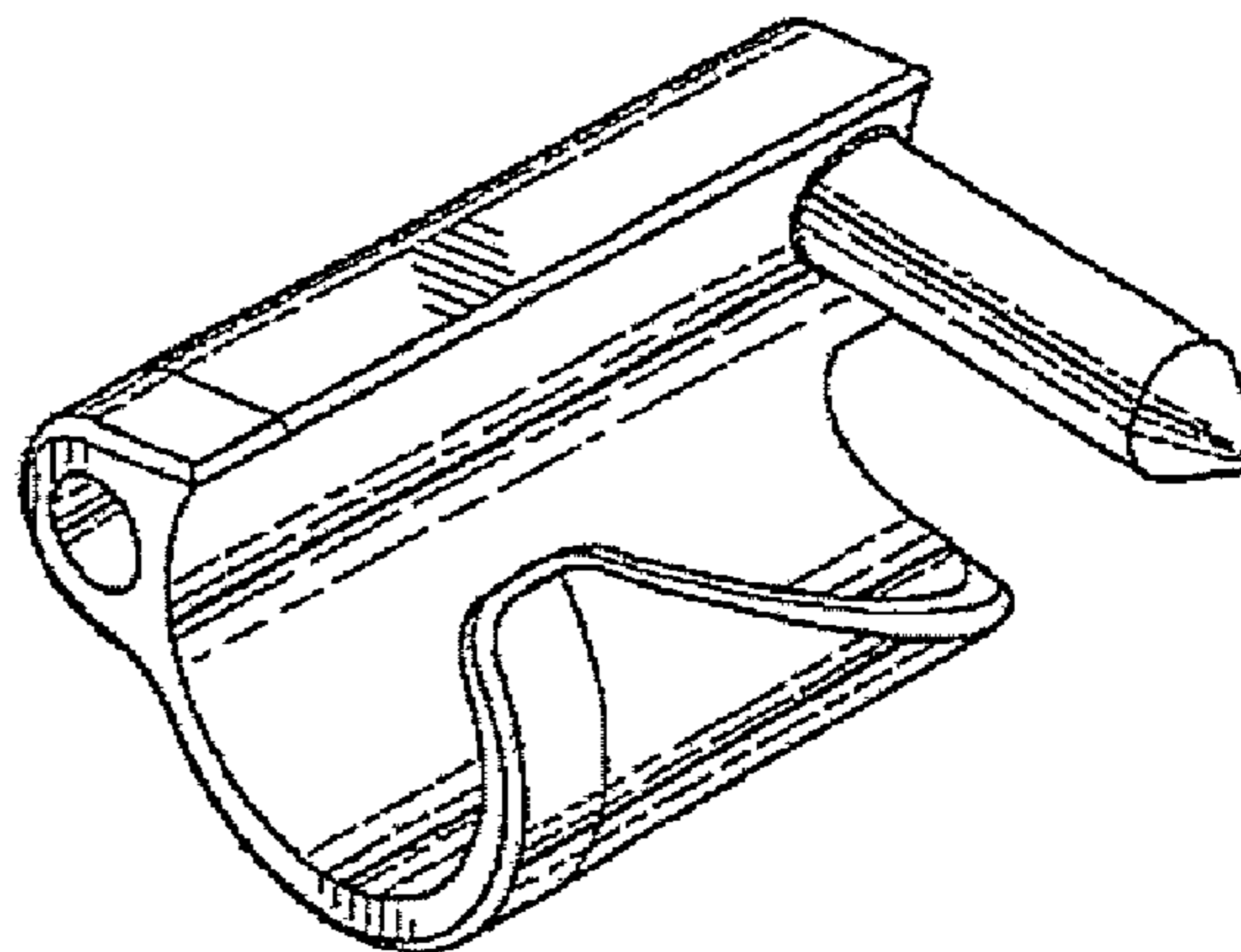
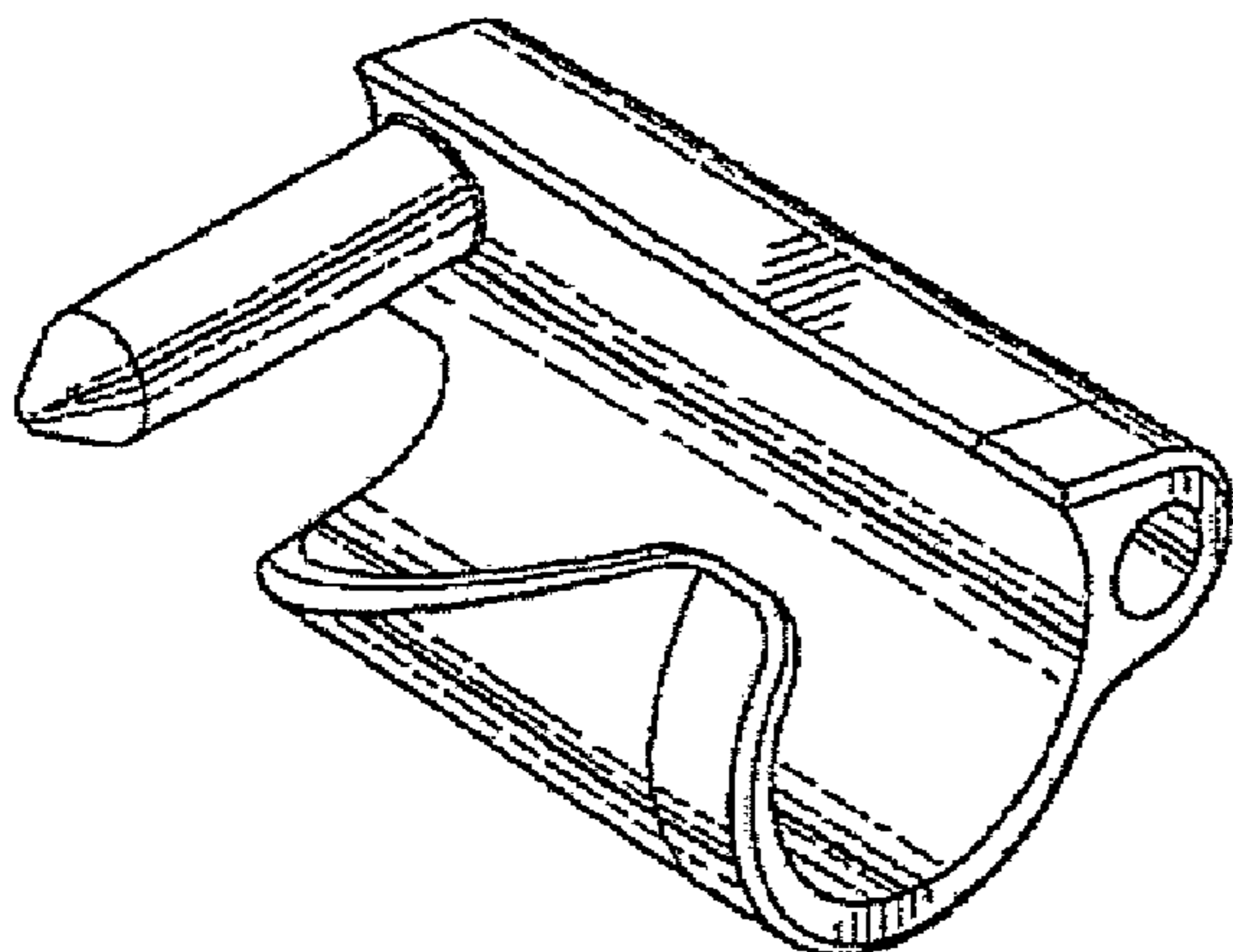

US D570,207 S

Page 2

U.S. PATENT DOCUMENTS								
5,553,822	A	9/1996	Barnard et al.	5,803,654	A	9/1998	Spease et al.	
5,570,611	A	11/1996	Pospisil et al.	5,807,018	A *	9/1998	Peek et al.	403/397
5,577,415	A	11/1996	Reasoner	5,846,017	A *	12/1998	Meyer	403/397
5,579,662	A	12/1996	Reasoner	D409,479	S	5/1999	Beugelsdyk et al.	
5,605,074	A	2/1997	Hall et al.	D425,784	S	5/2000	Beugelsdyk et al.	
5,615,583	A	4/1997	Cunningham et al.	6,498,903	B2 *	12/2002	Omiya	396/379
5,632,182	A	5/1997	Reasoner	7,280,287	B2 *	10/2007	Yamane	359/698
5,634,379	A	6/1997	Barnard	2002/0071674	A1 *	6/2002	Omiya	396/379

* cited by examiner

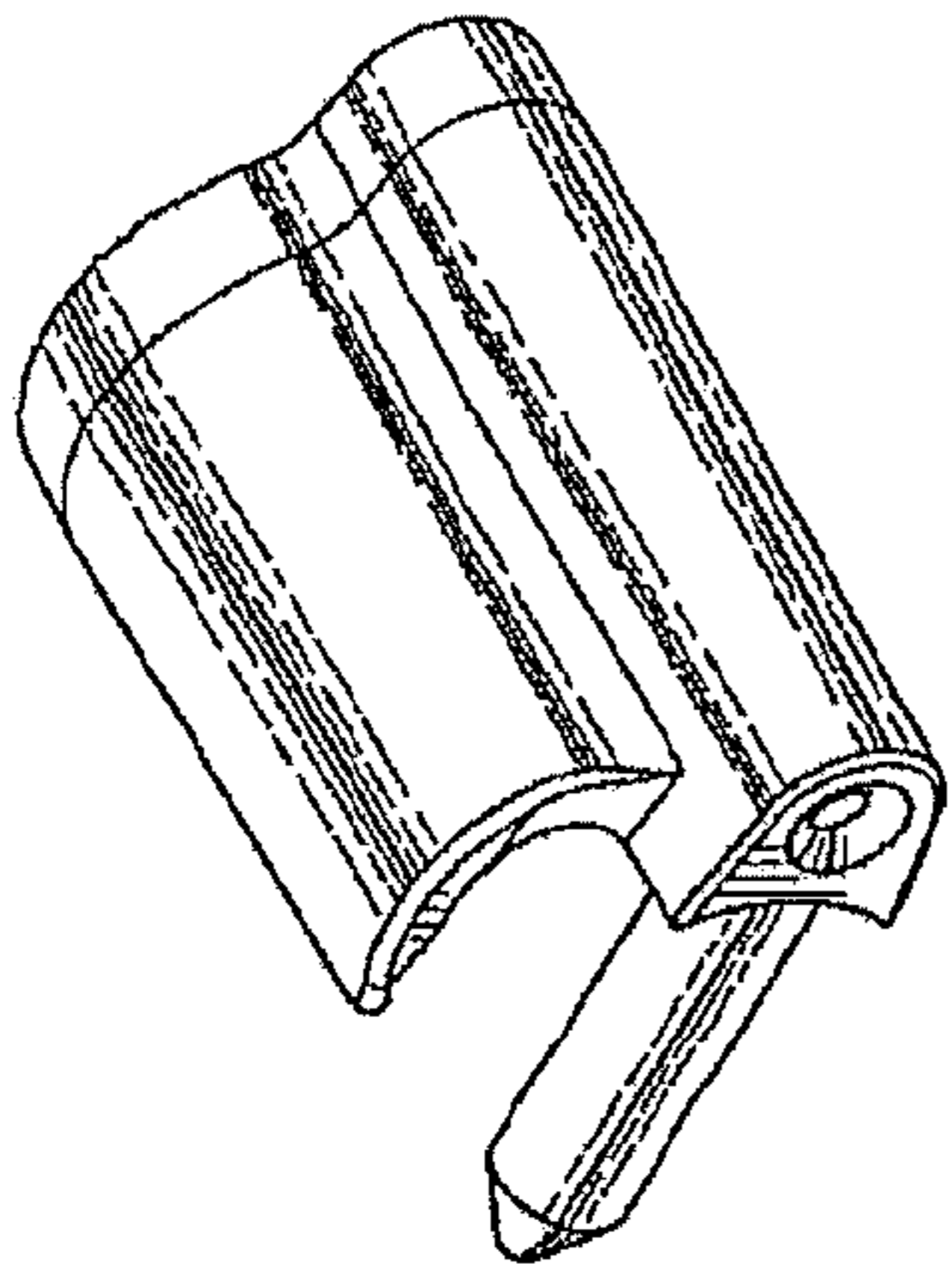

Fig. 1.

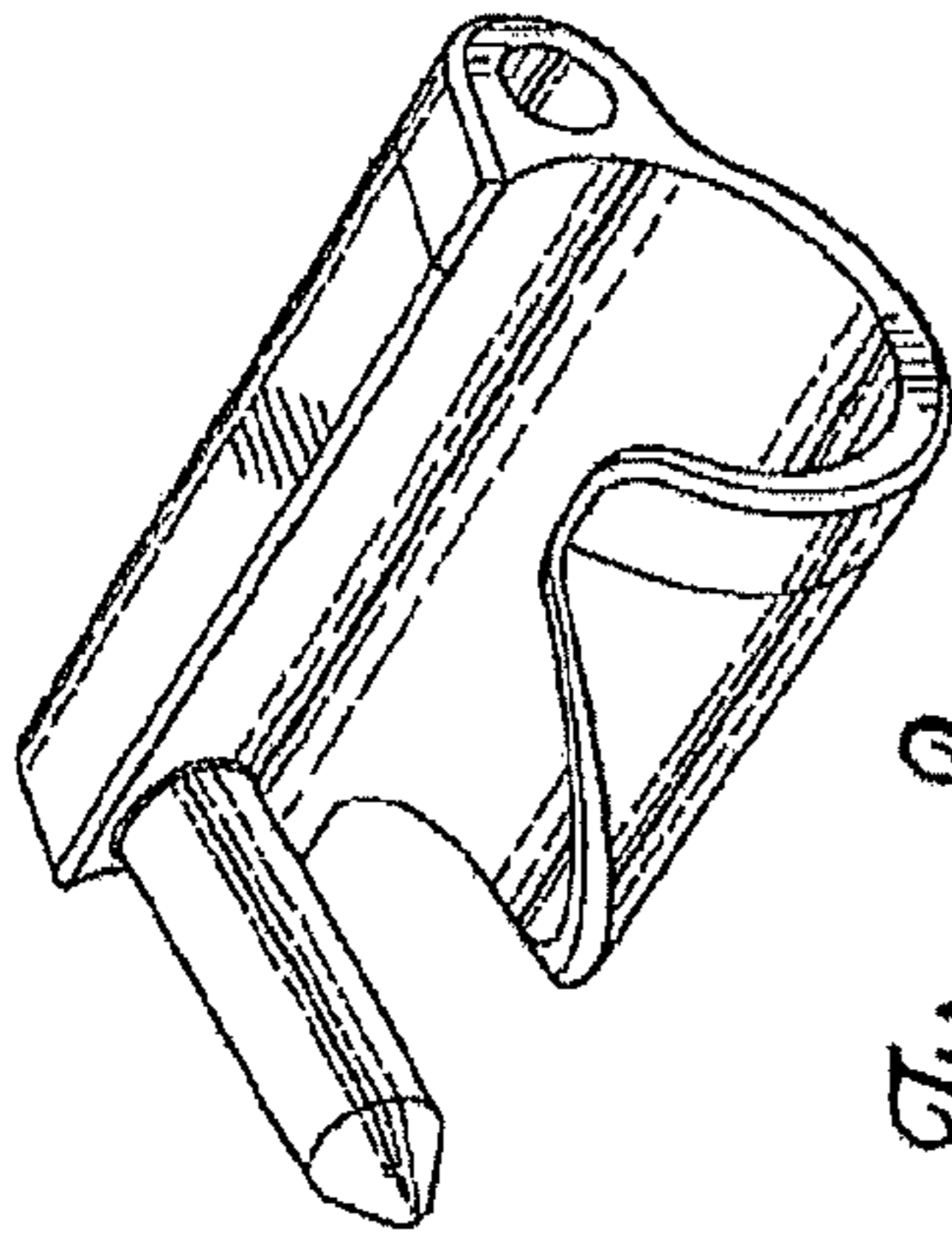

Fig. 2.

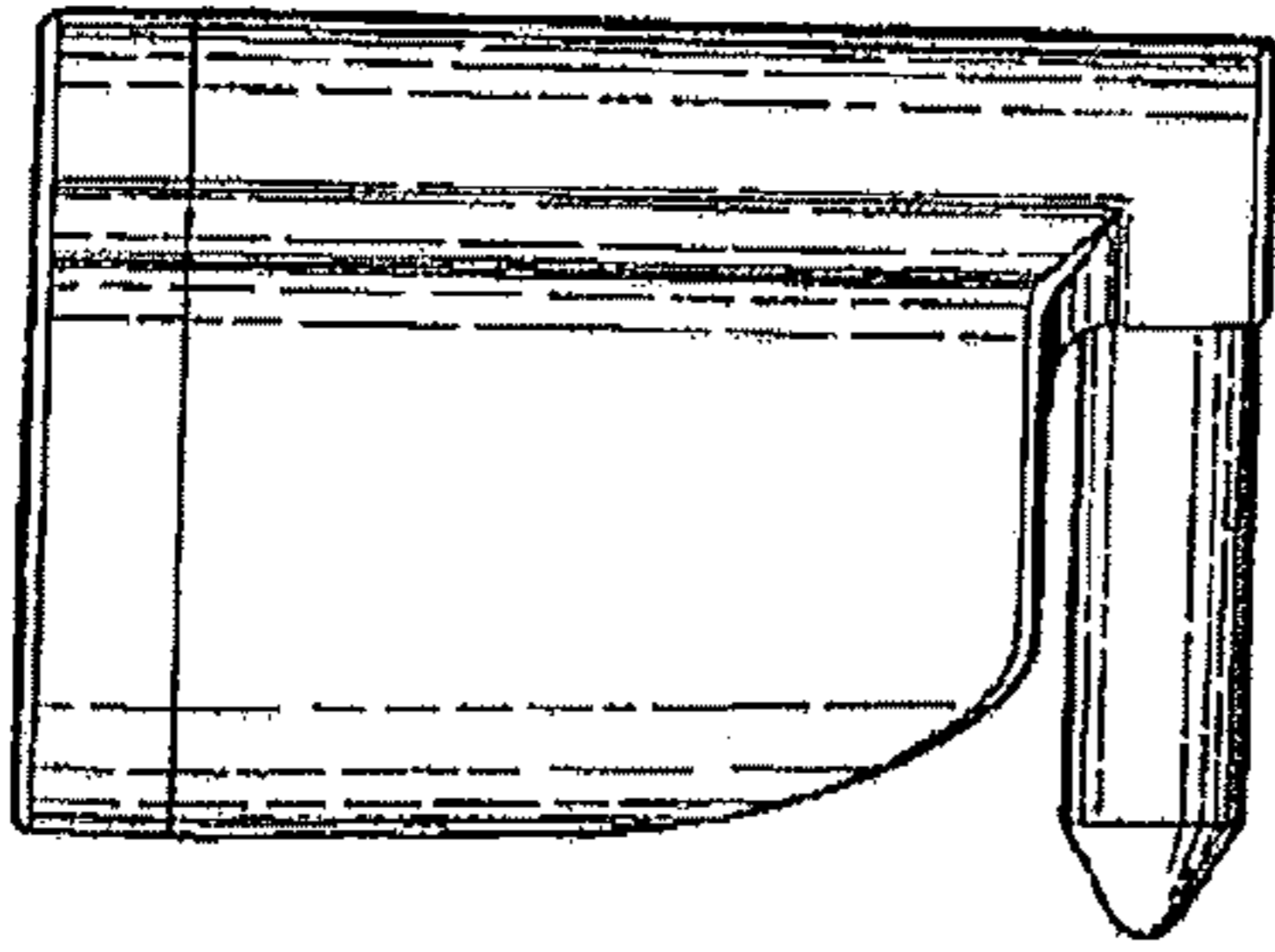

Fig. 3.

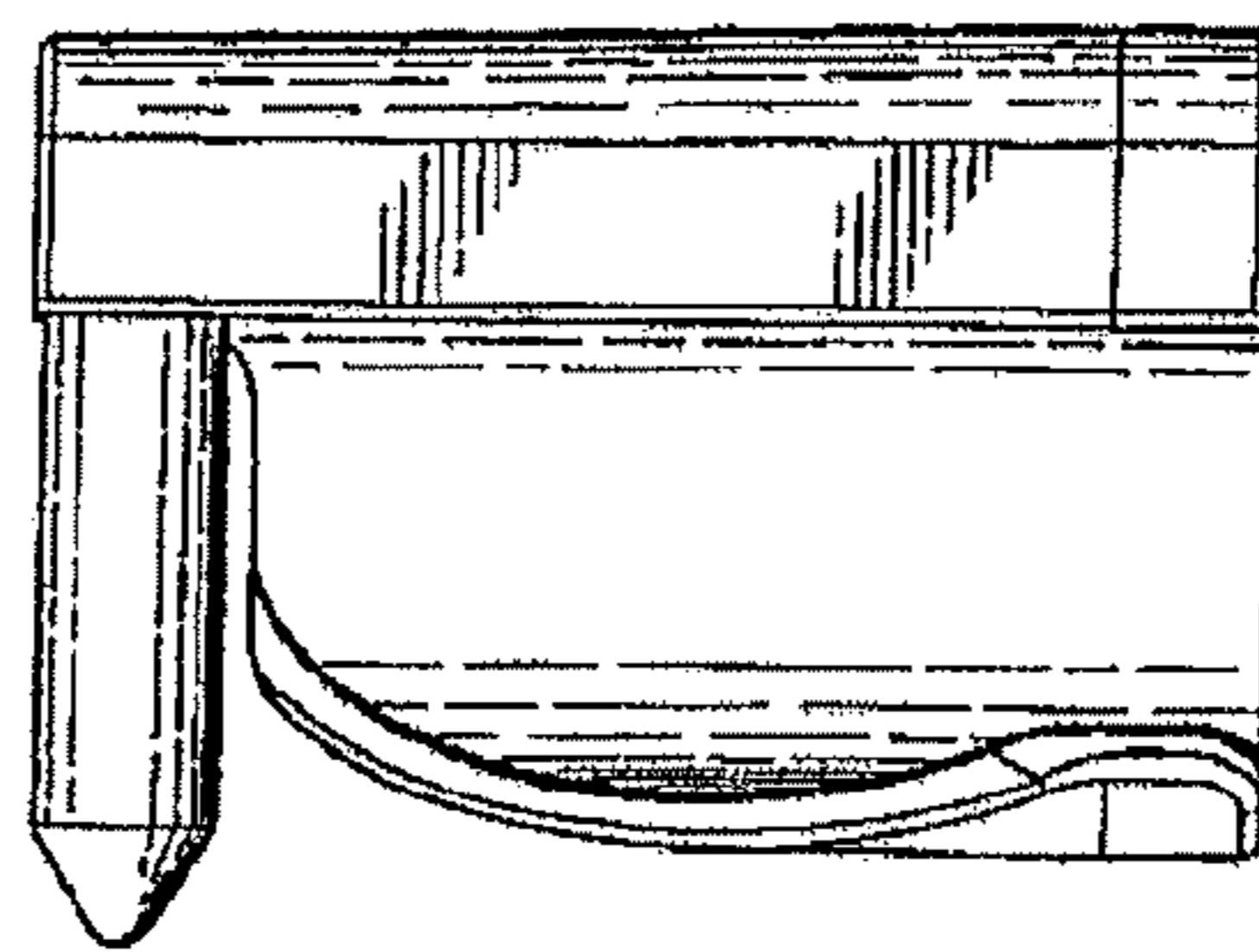

Fig. 4.

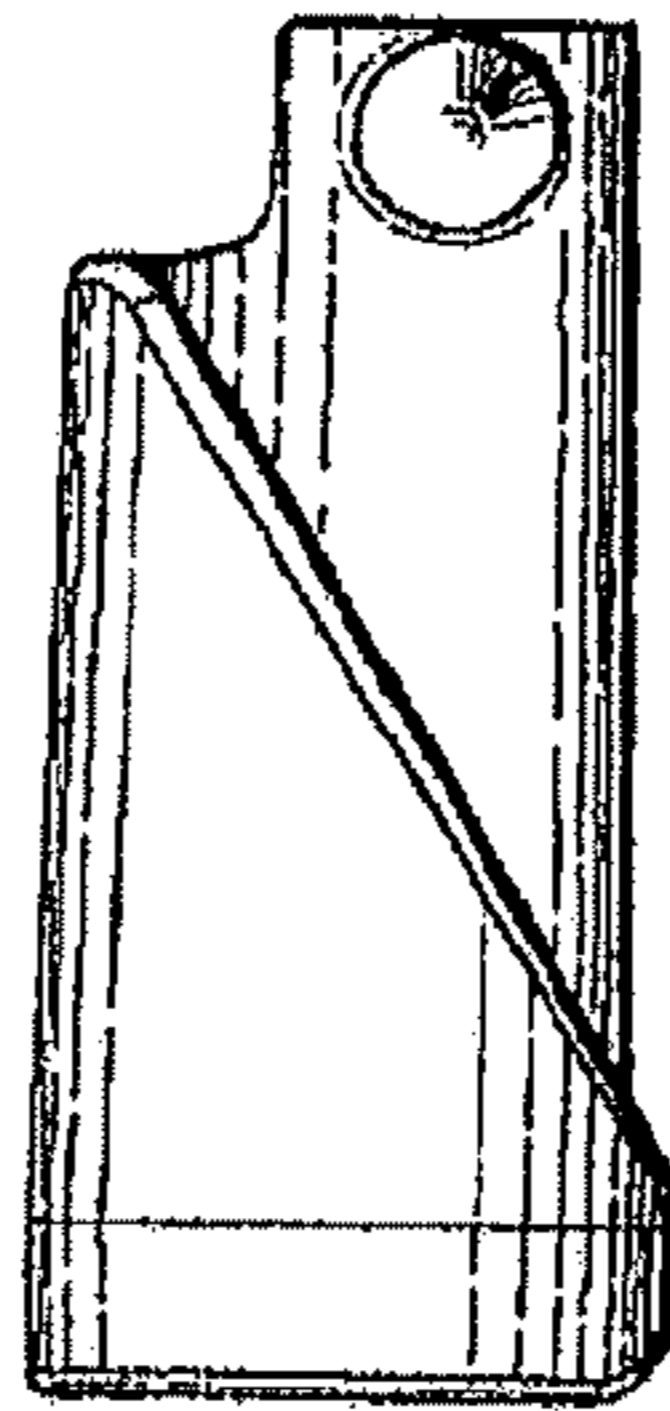

Fig. 5.

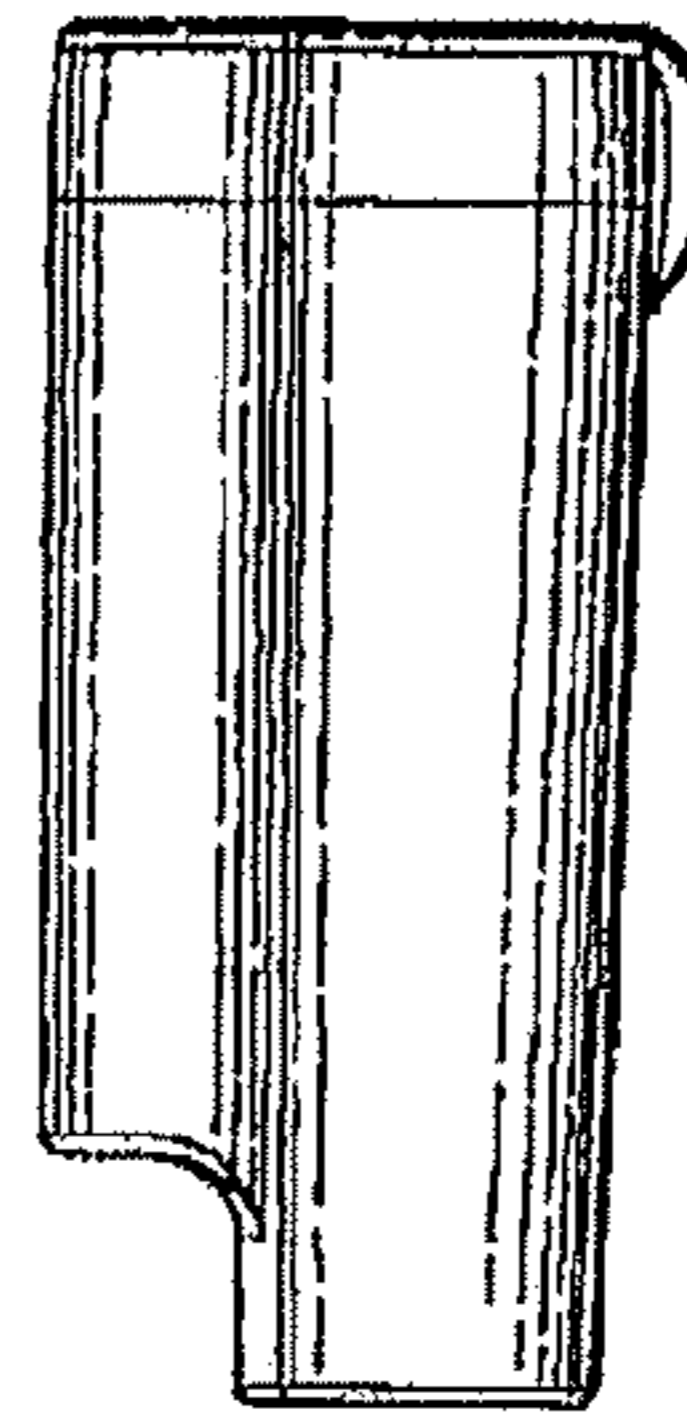

Fig. 6.

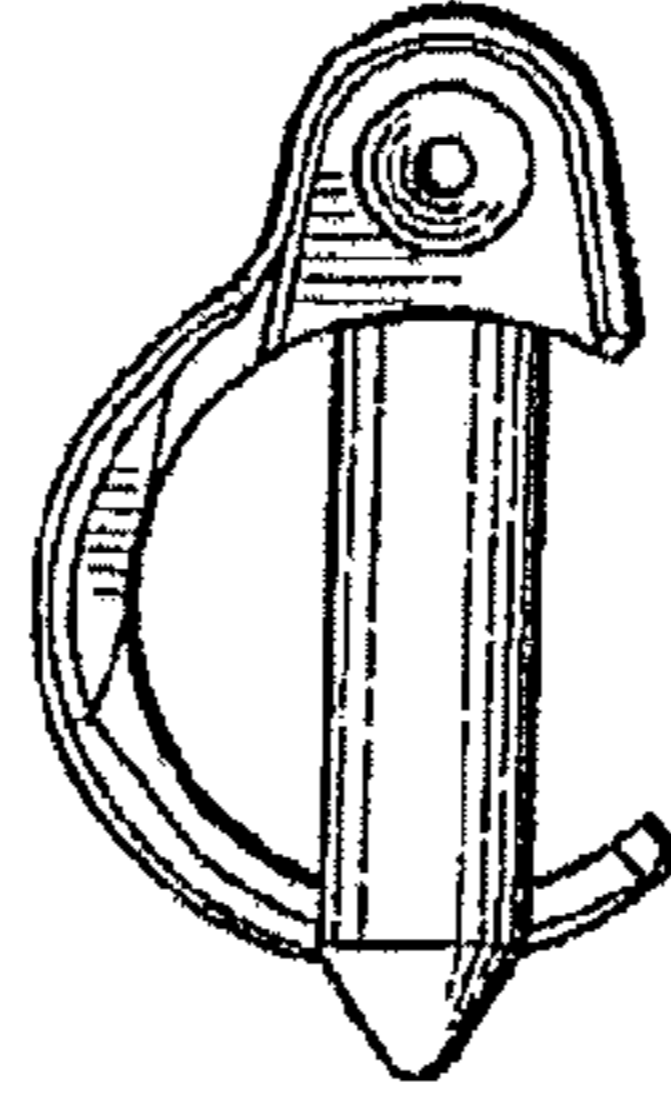

Fig. 7.

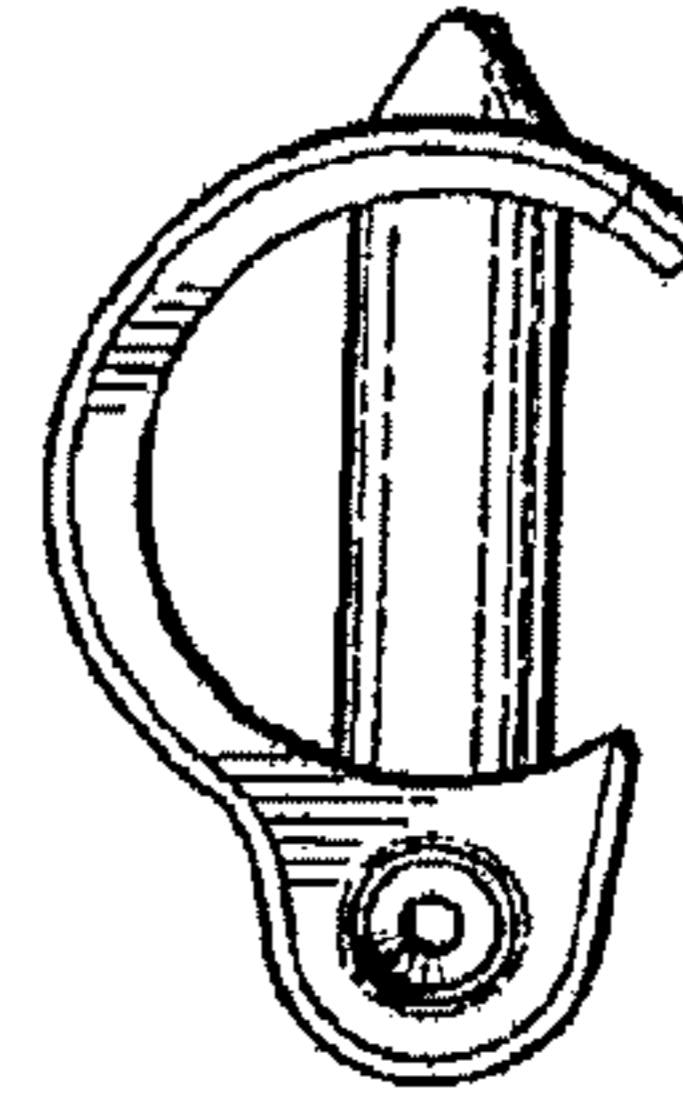

Fig. 8.

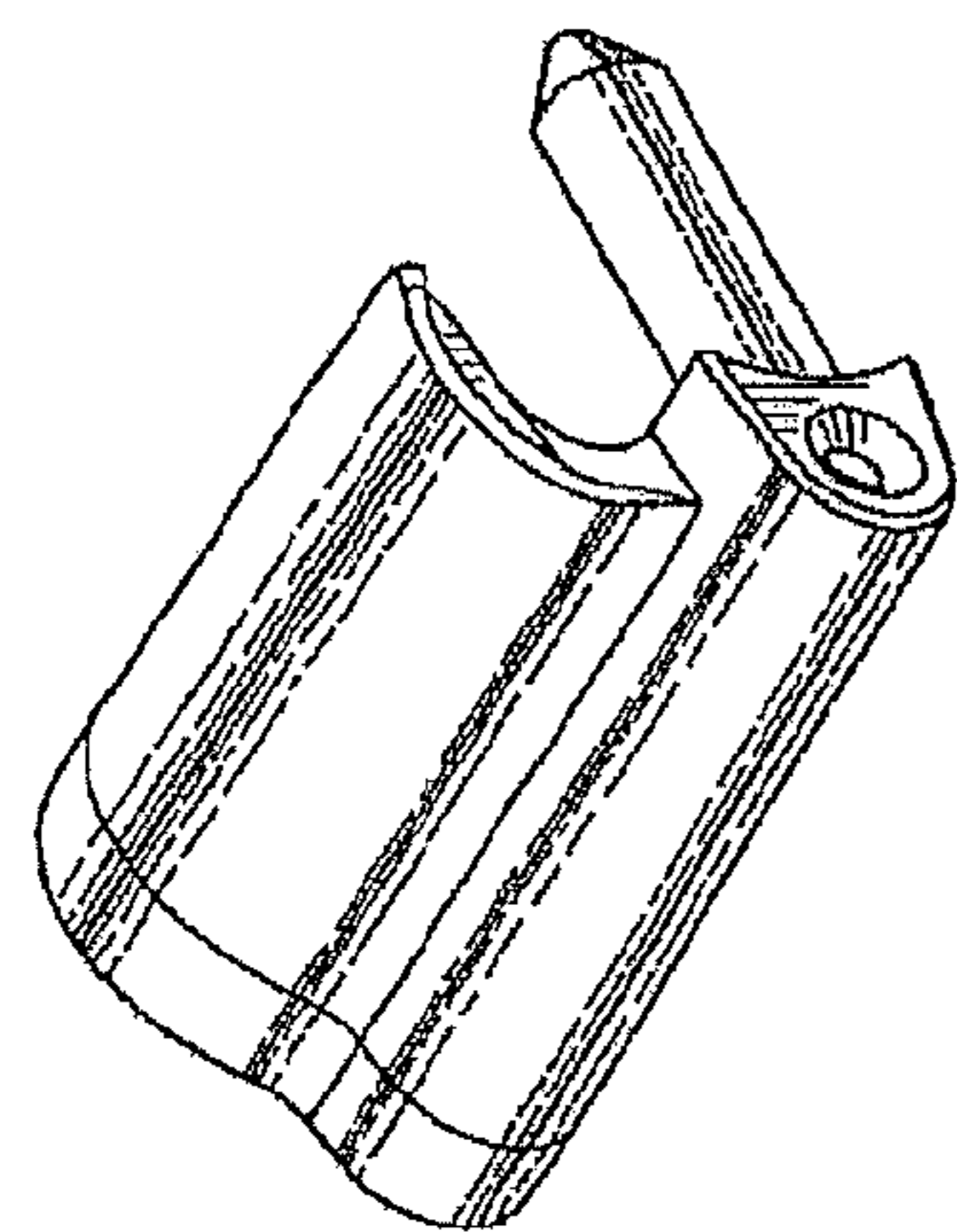

Fig. 9.

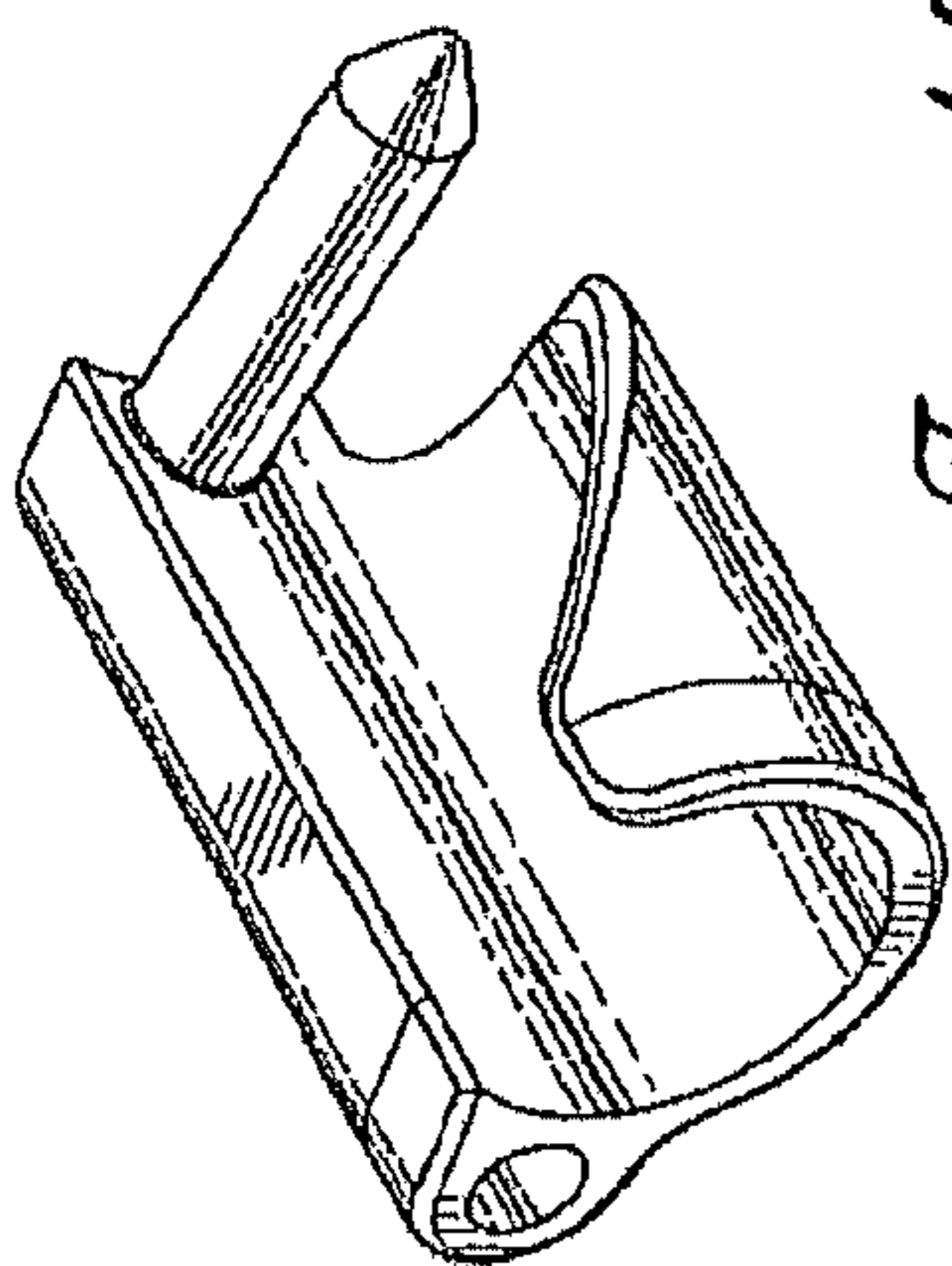

Fig. 10.

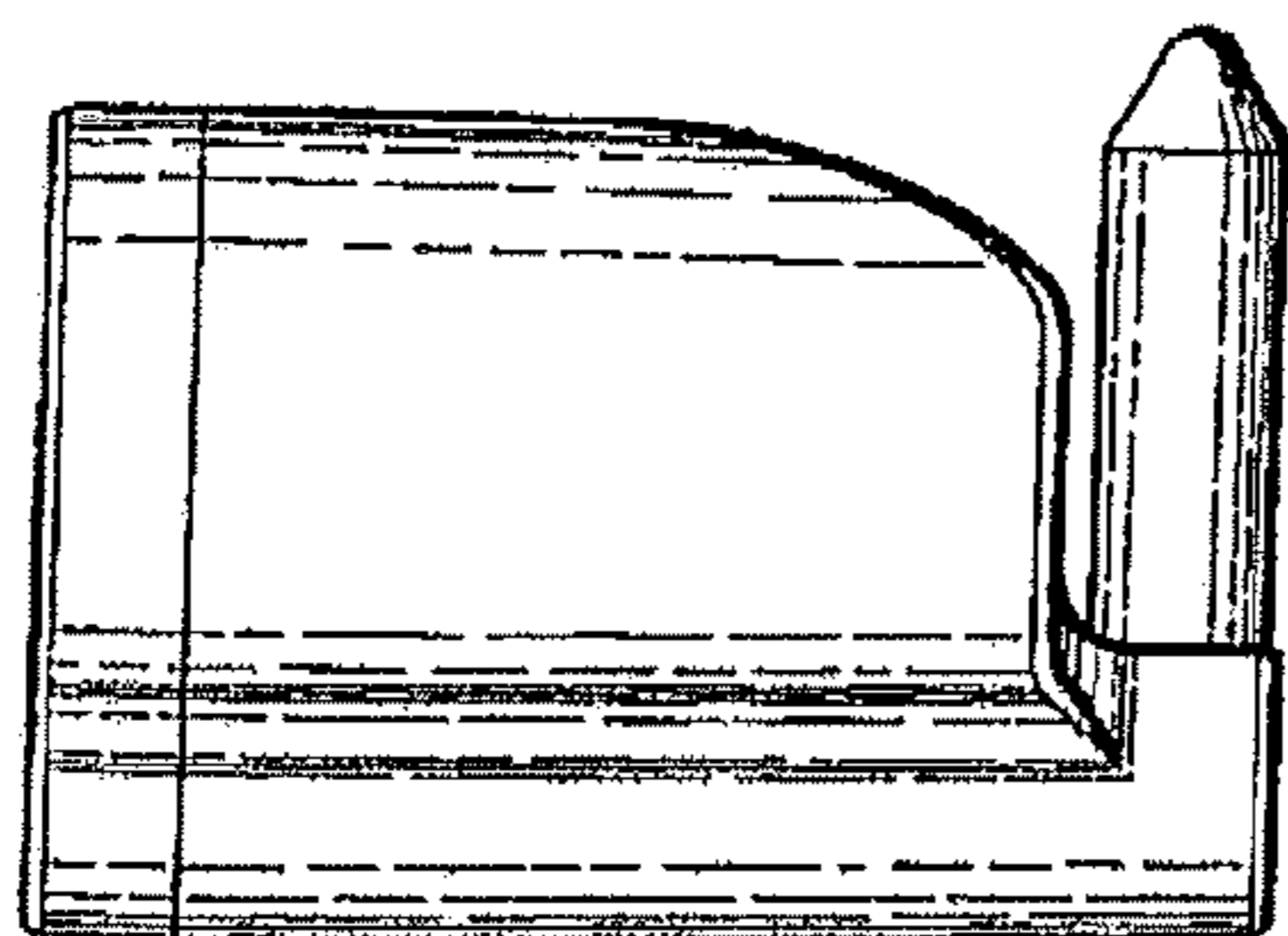

Fig. 11.

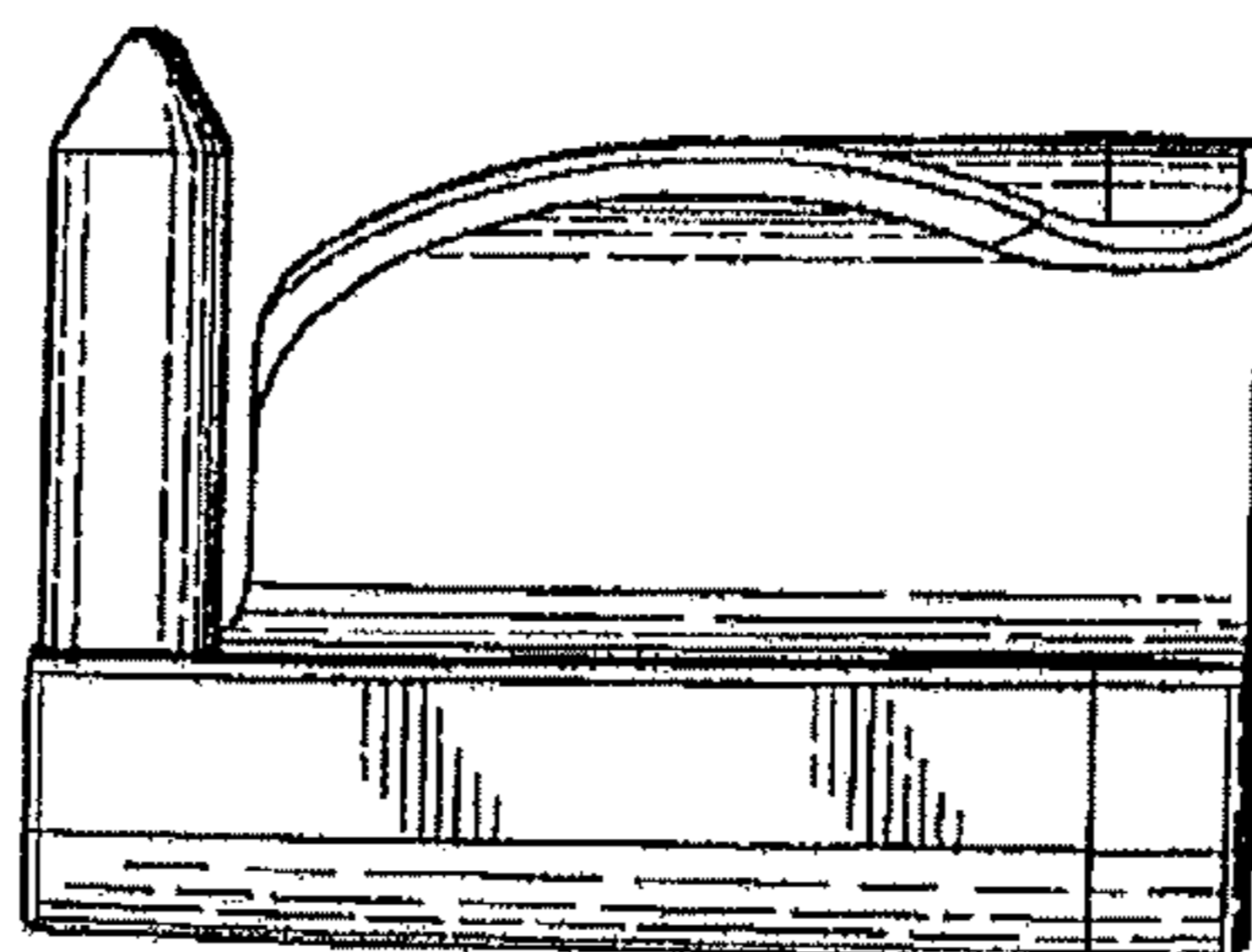

Fig. 12.

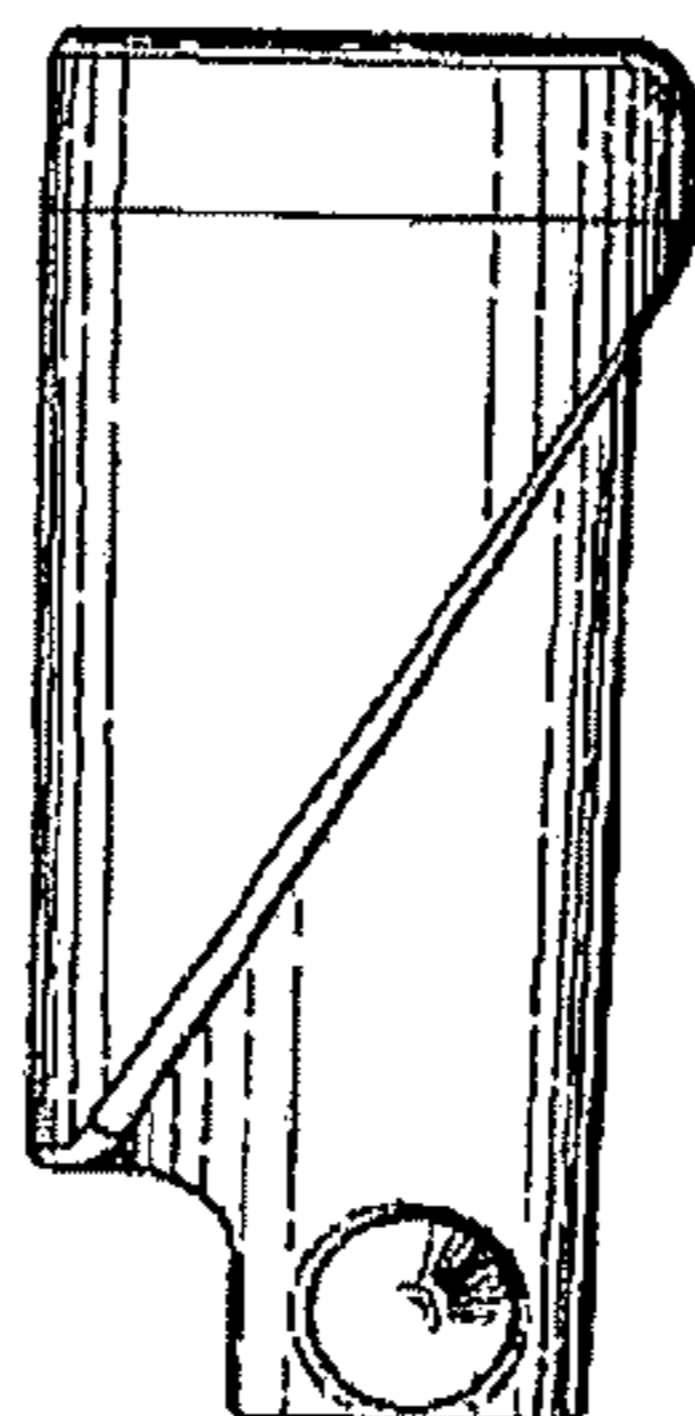

Fig. 13.

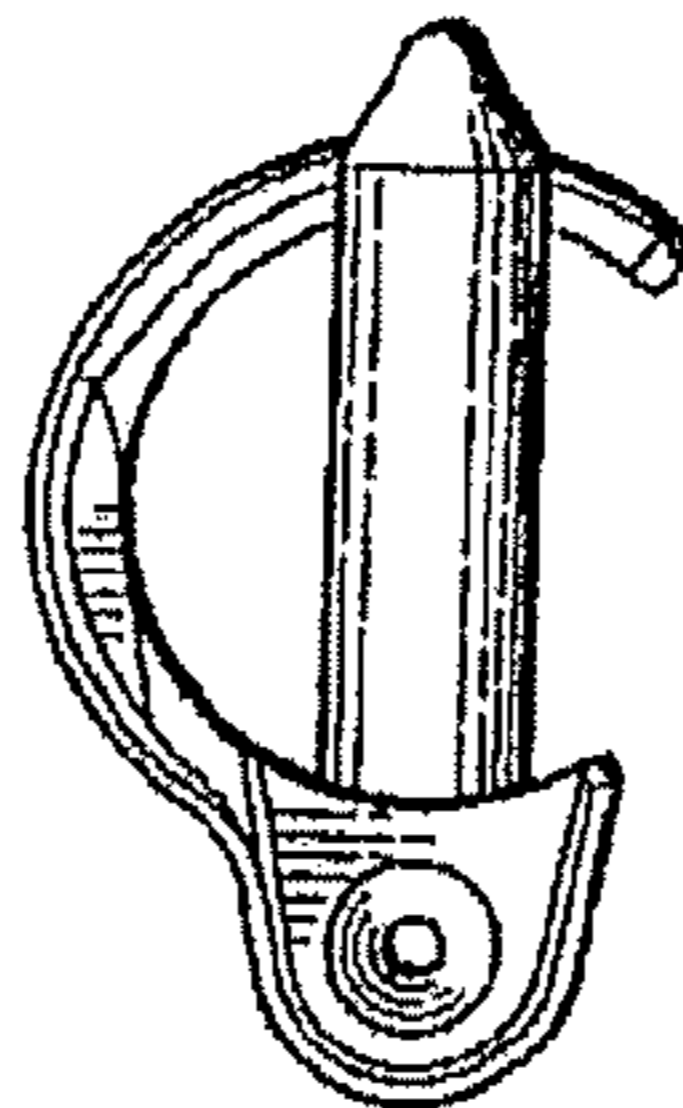

Fig. 15.

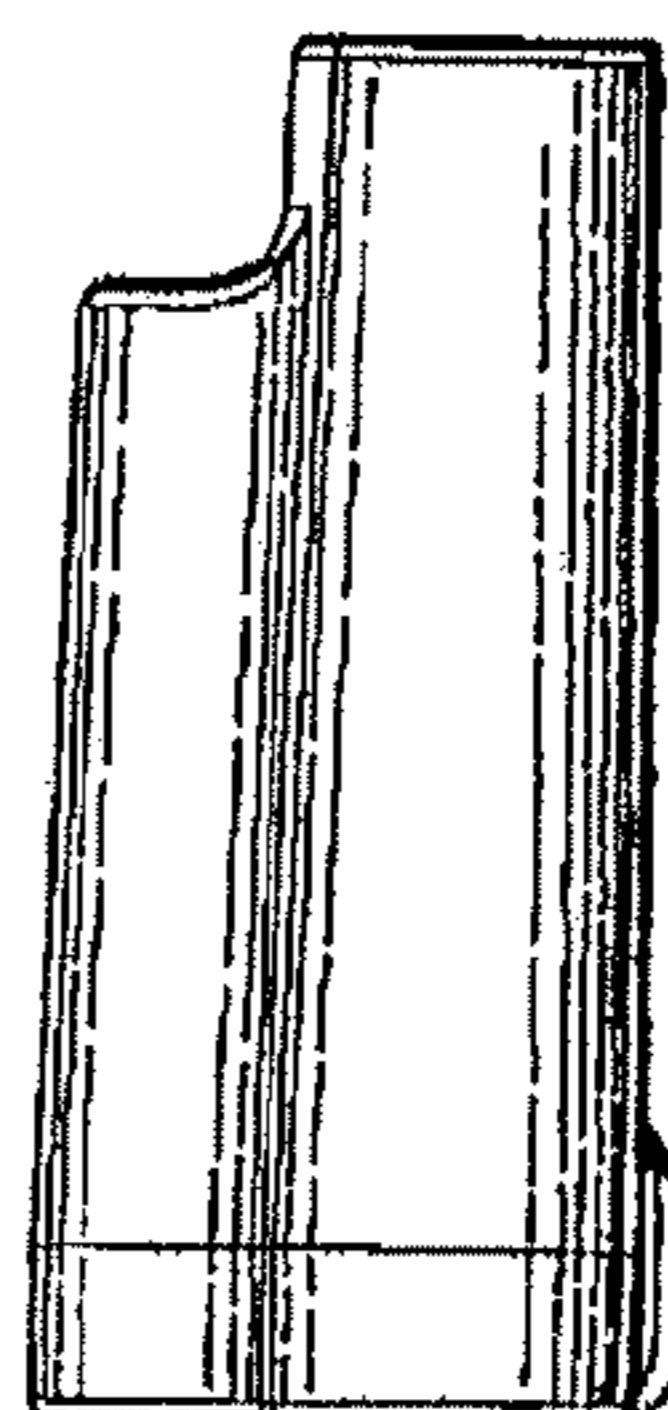

Fig. 14.

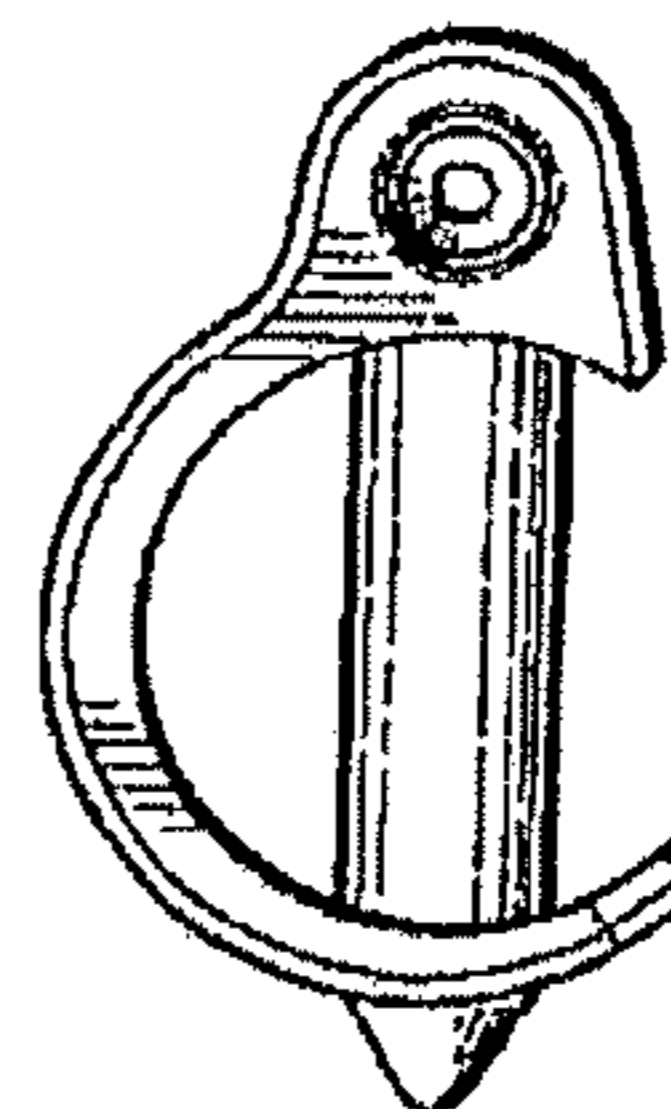

Fig. 16.