

US00D570120S

(12) **United States Design Patent**  
**Goodman et al.**

(10) **Patent No.:** **US D570,120 S**  
(45) **Date of Patent:** **\*\* Jun. 3, 2008**

(54) **COOKBOOK HOLDER**

6,574,897 B1 \* 6/2003 Timmer ..... 40/800  
D526,858 S \* 8/2006 Goodman et al. .... D7/631

(75) Inventors: **Sheldon H. Goodman**, Solon, OH  
(US); **Kent W. Murphy**, Wooster, OH  
(US)

\* cited by examiner

*Primary Examiner*—Caron D. Veynar  
*Assistant Examiner*—Sydney R Buffalow

(73) Assignee: **Spectrum Diversified Designs, Inc.**,  
Streetsboro, OH (US)

(74) *Attorney, Agent, or Firm*—Pearne & Gordon LLP

(\*\*) Term: **14 Years**

(57) **CLAIM**

(21) Appl. No.: **29/275,924**

The ornamental design for a cookbook holder, as shown and described.

(22) Filed: **Jan. 10, 2007**

**DESCRIPTION**

(51) **LOC (8) Cl.** ..... **06-04**

FIG. 1 is a perspective view of a cookbook holder, showing our new design;

(52) **U.S. Cl.** ..... **D6/310**

FIG. 2 is a front elevational view thereof;

(58) **Field of Classification Search** ..... D6/419,  
D6/310, 303, 428, 300, 311; D7/631; 40/700,  
40/777, 743, 800

FIG. 3 is a side elevational view thereof;

See application file for complete search history.

FIG. 4 is a top plan view thereof;

FIG. 5 is a rear elevational view thereof; and,

FIG. 6 is a bottom plan view thereof.

The broken-line disclosure of elements in the views is for illustrative purposes only and forms no part of the claimed design.

(56) **References Cited**

U.S. PATENT DOCUMENTS

D106,297 S \* 10/1937 Krick ..... D6/428  
D359,399 S \* 6/1995 Rath ..... D6/419  
D362,123 S \* 9/1995 Johnston et al. .... D6/303  
D396,561 S \* 8/1998 Gregory ..... D6/303

**1 Claim, 4 Drawing Sheets**

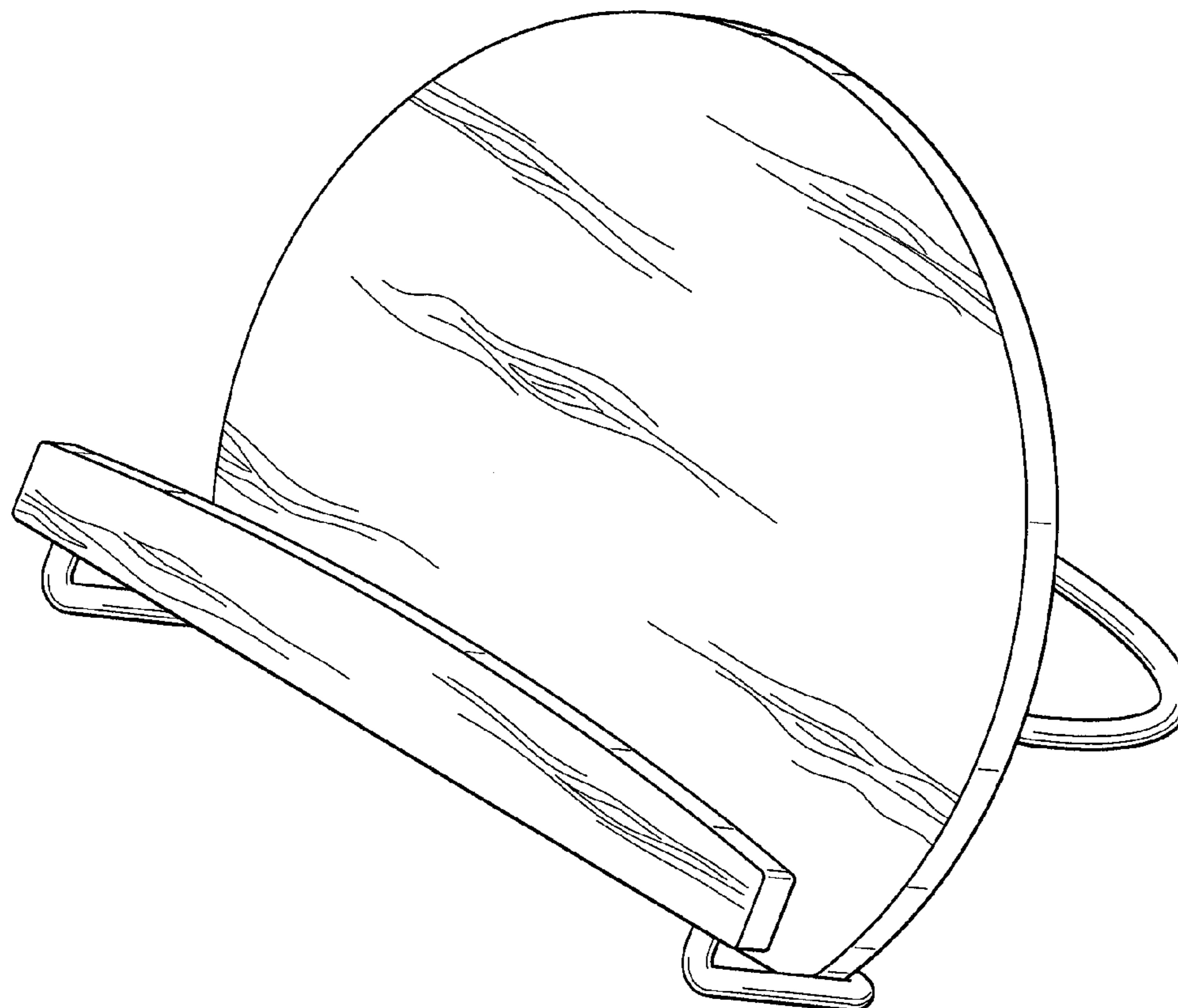

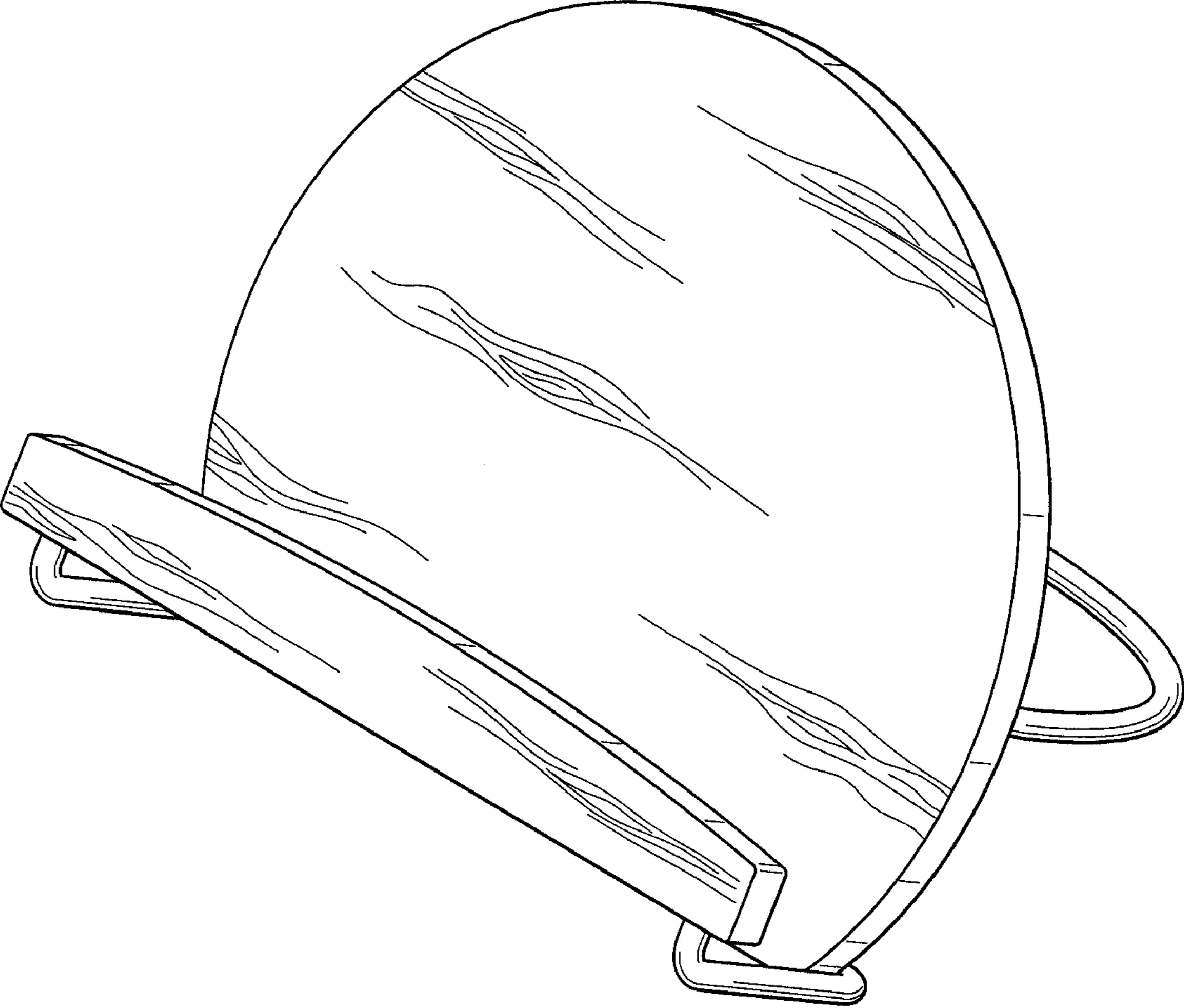

FIG. 1

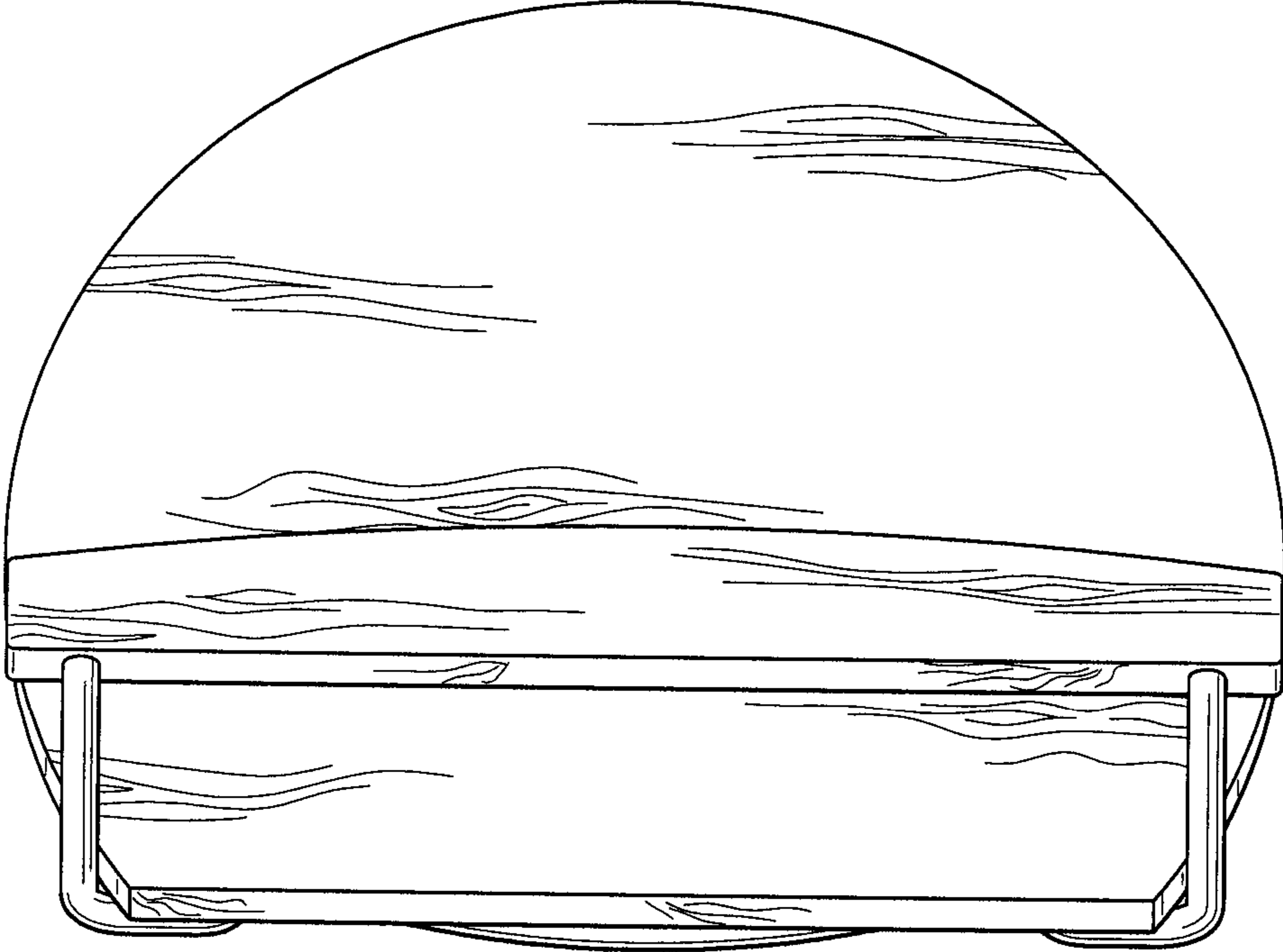

FIG. 2

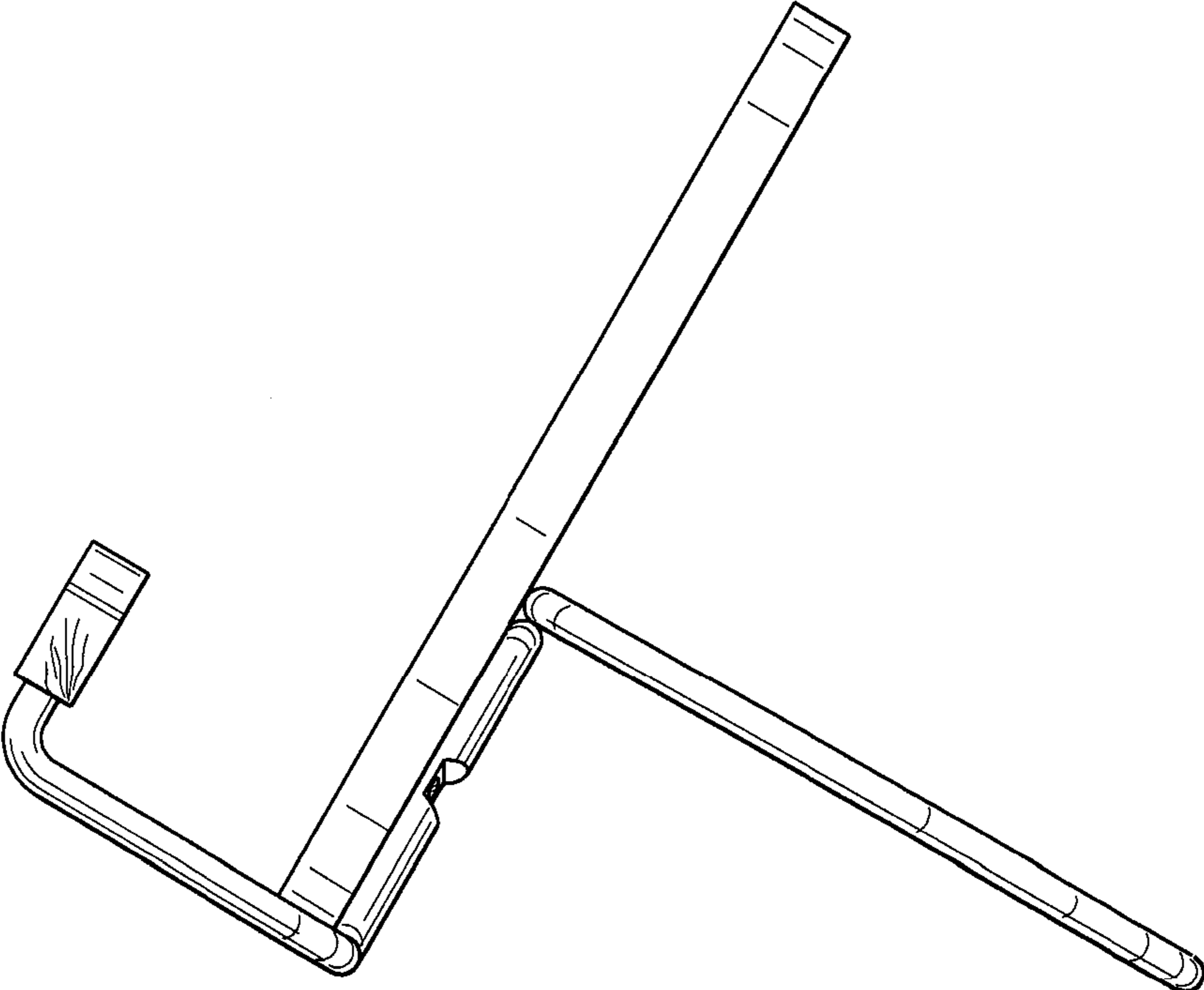

FIG. 3

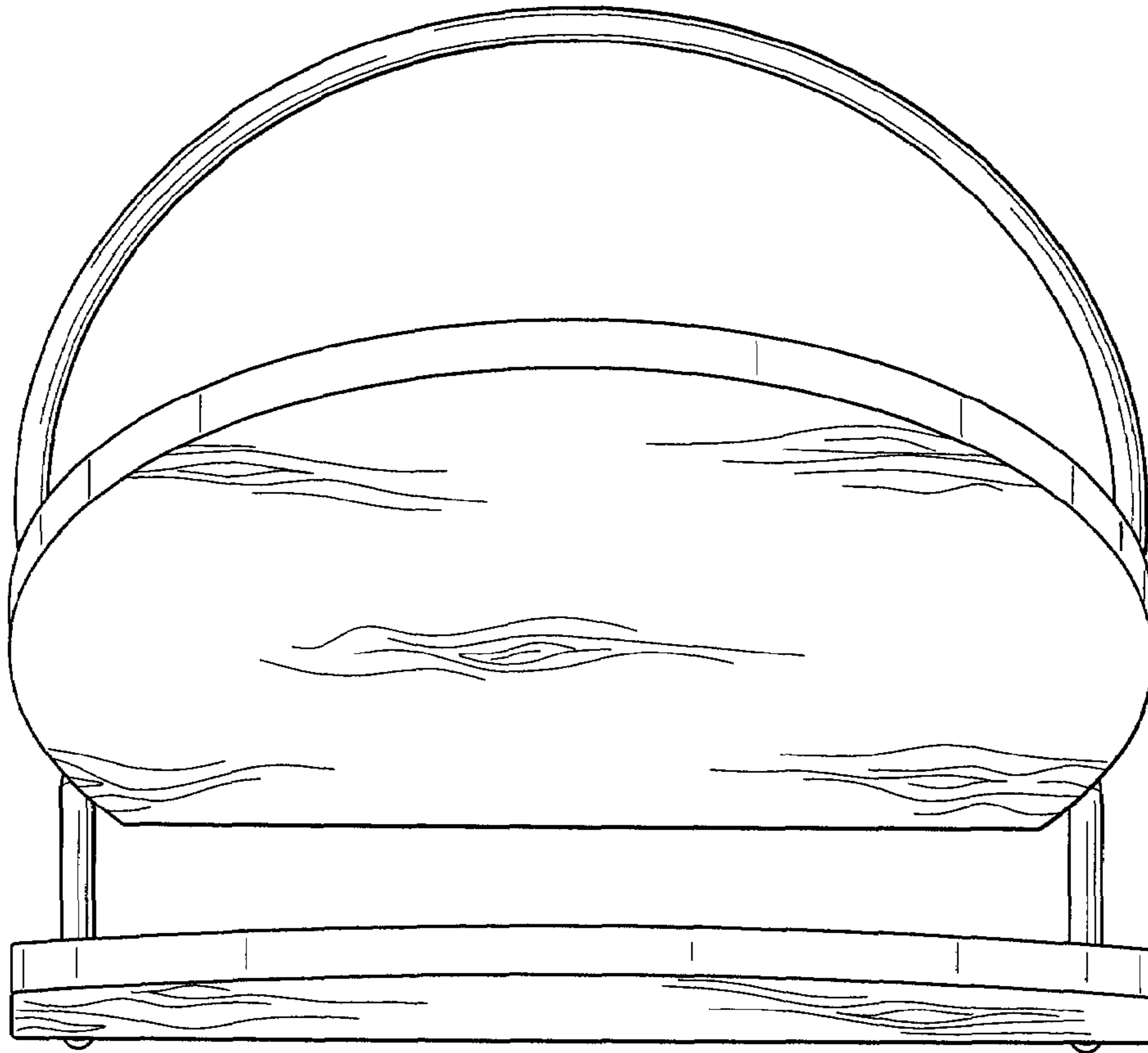

FIG. 4

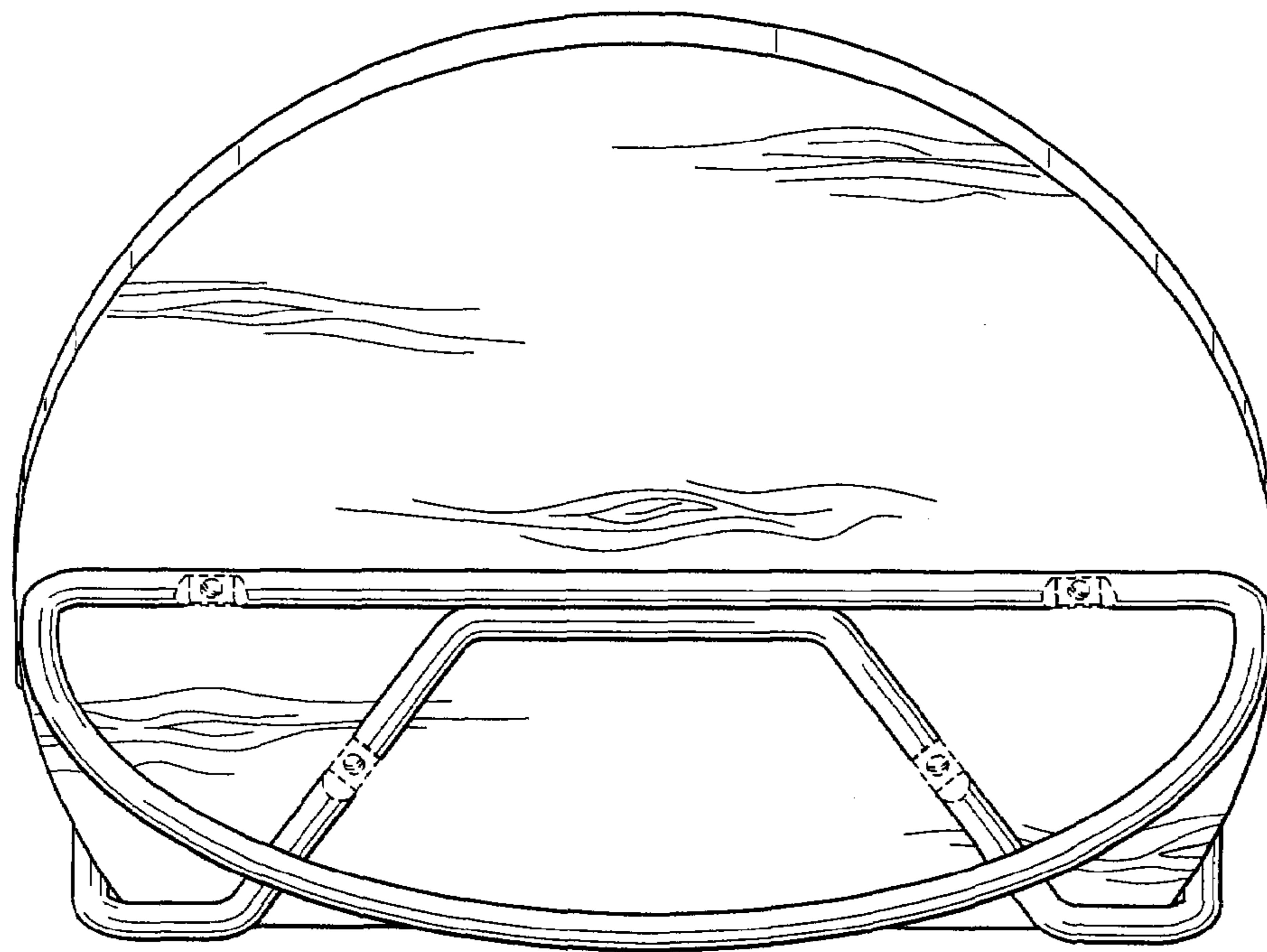

FIG. 5



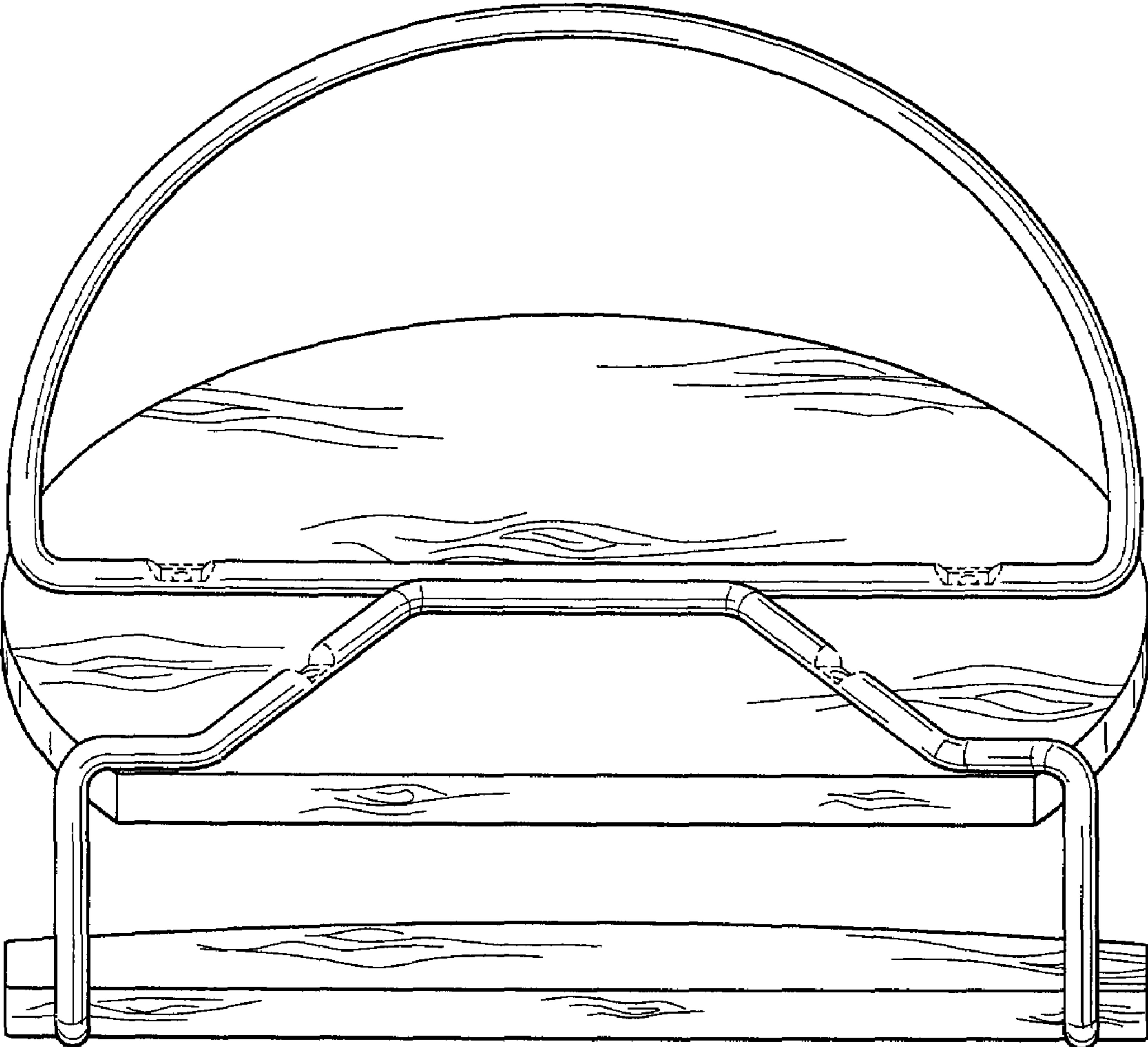

FIG. 6