



US00D570028S

(12) **United States Design Patent**  
**Curtin**

(10) **Patent No.:** **US D570,028 S**

(45) **Date of Patent:** **\*\* May 27, 2008**

(54) **LIGHT FIXTURE**

(75) Inventor: **Brett Curtin**, Scottsdale, AZ (US)

(73) Assignee: **Craftmade International, Inc.**,  
Coppell, TX (US)

(\*\*) Term: **14 Years**

(21) Appl. No.: **29/292,378**

(22) Filed: **Oct. 10, 2007**

(51) **LOC (8) Cl.** ..... **26-03**

(52) **U.S. Cl.** ..... **D26/85; D26/87**

(58) **Field of Classification Search** ..... D26/72,  
D26/85-87, 92, 118; 362/147, 432, 806,  
362/351, 355, 356, 363, 370

See application file for complete search history.

(56) **References Cited**

**U.S. PATENT DOCUMENTS**

D463,606 S	*	9/2002	Orozco	.....	D26/87
D512,174 S	*	11/2005	Flores	.....	D26/92
D513,338 S	*	12/2005	Burke	.....	D26/87
D515,724 S	*	2/2006	Tien et al.	.....	D26/85
D534,298 S	*	12/2006	Chen	.....	D26/87
D535,426 S	*	1/2007	Holman	.....	D26/87

**OTHER PUBLICATIONS**

The "Castle Collection" from the Murray-Feiss 2004 Edition of "The Big Book" catalog.\*

\* cited by examiner

*Primary Examiner*—Clare E Heflin

(74) *Attorney, Agent, or Firm*—Munsch, Hardt, Kopf & Harr, P.C.

(57) **CLAIM**

The ornamental design for a light fixture, as shown and described.

**DESCRIPTION**

FIG. 1 is a perspective view of the light fixture showing my new design;

FIG. 2 front elevational view thereof;

FIG. 3 is a right side elevational view thereof

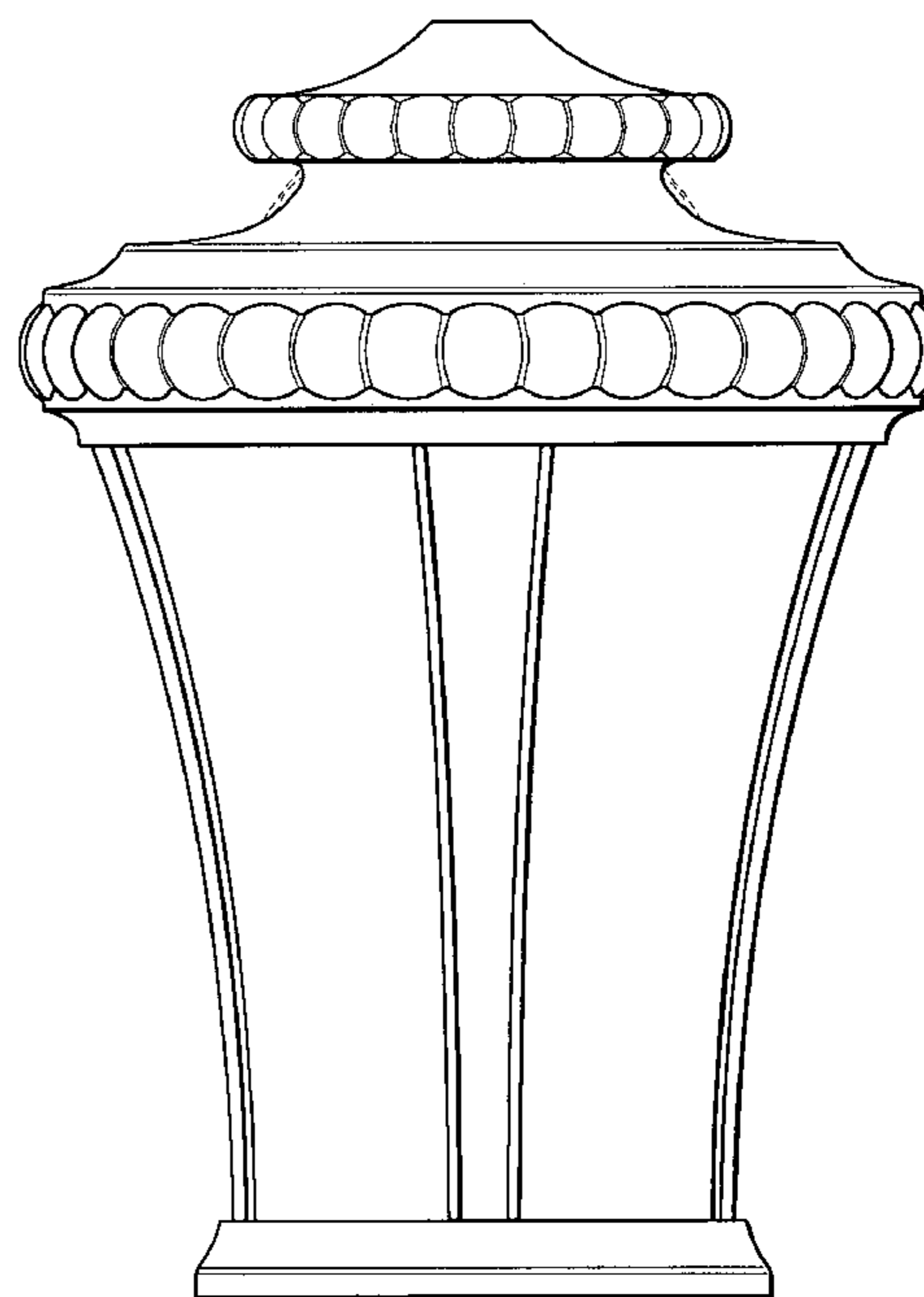
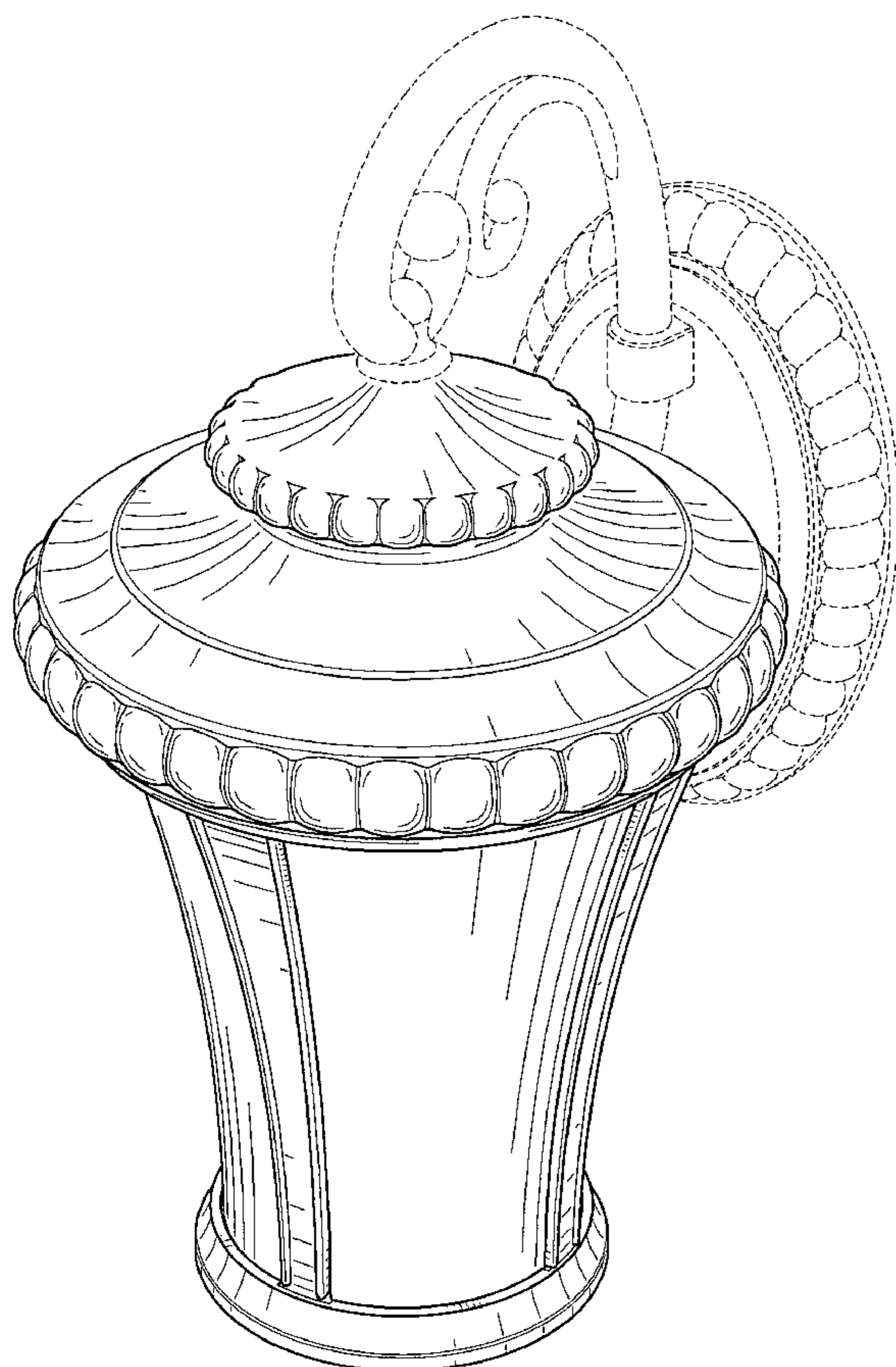
FIG. 4 is rear elevational view thereof;

FIG. 5 is a top plan view thereof; and,

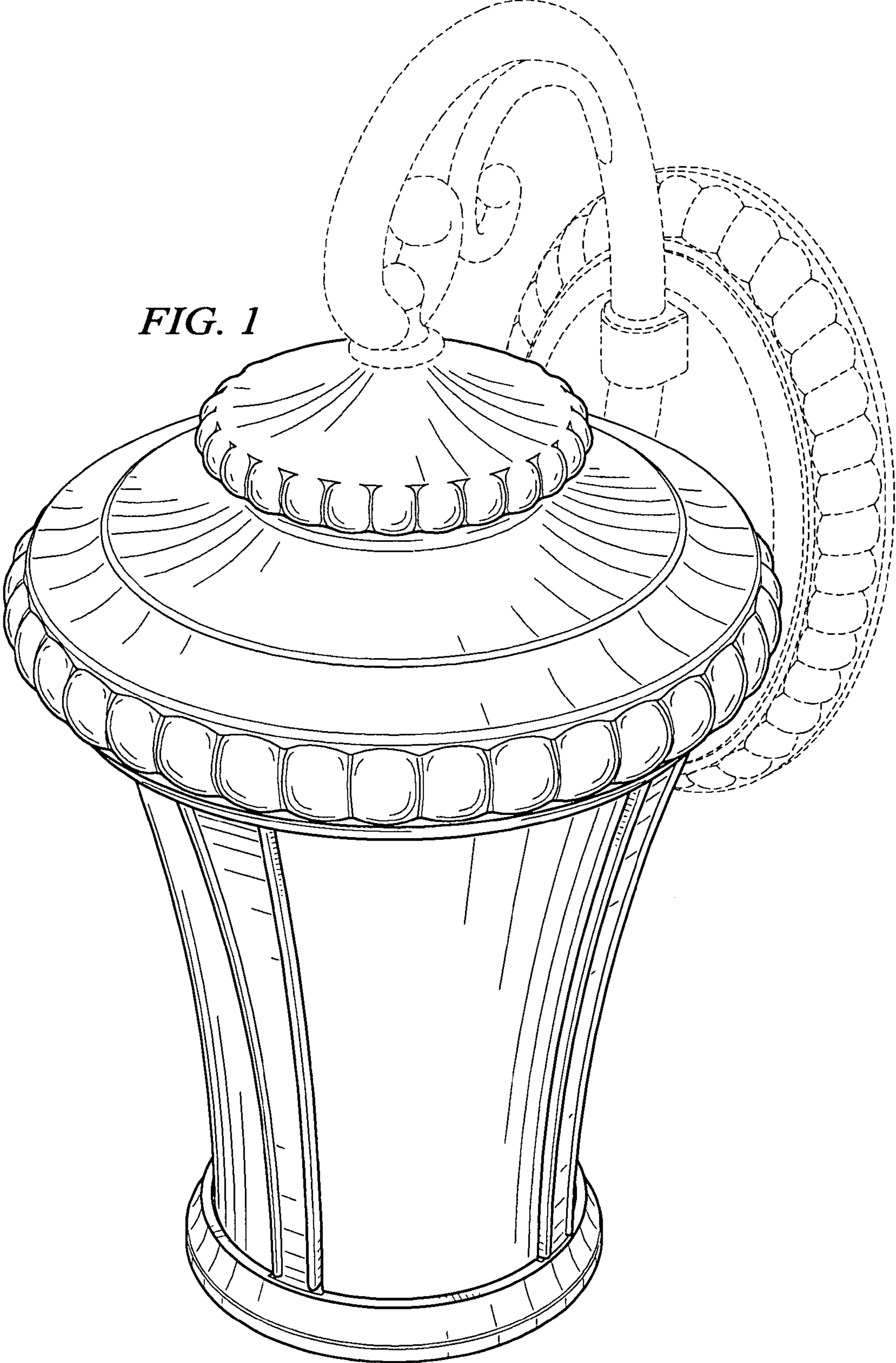
FIG. 6 is a bottom plan view thereof.

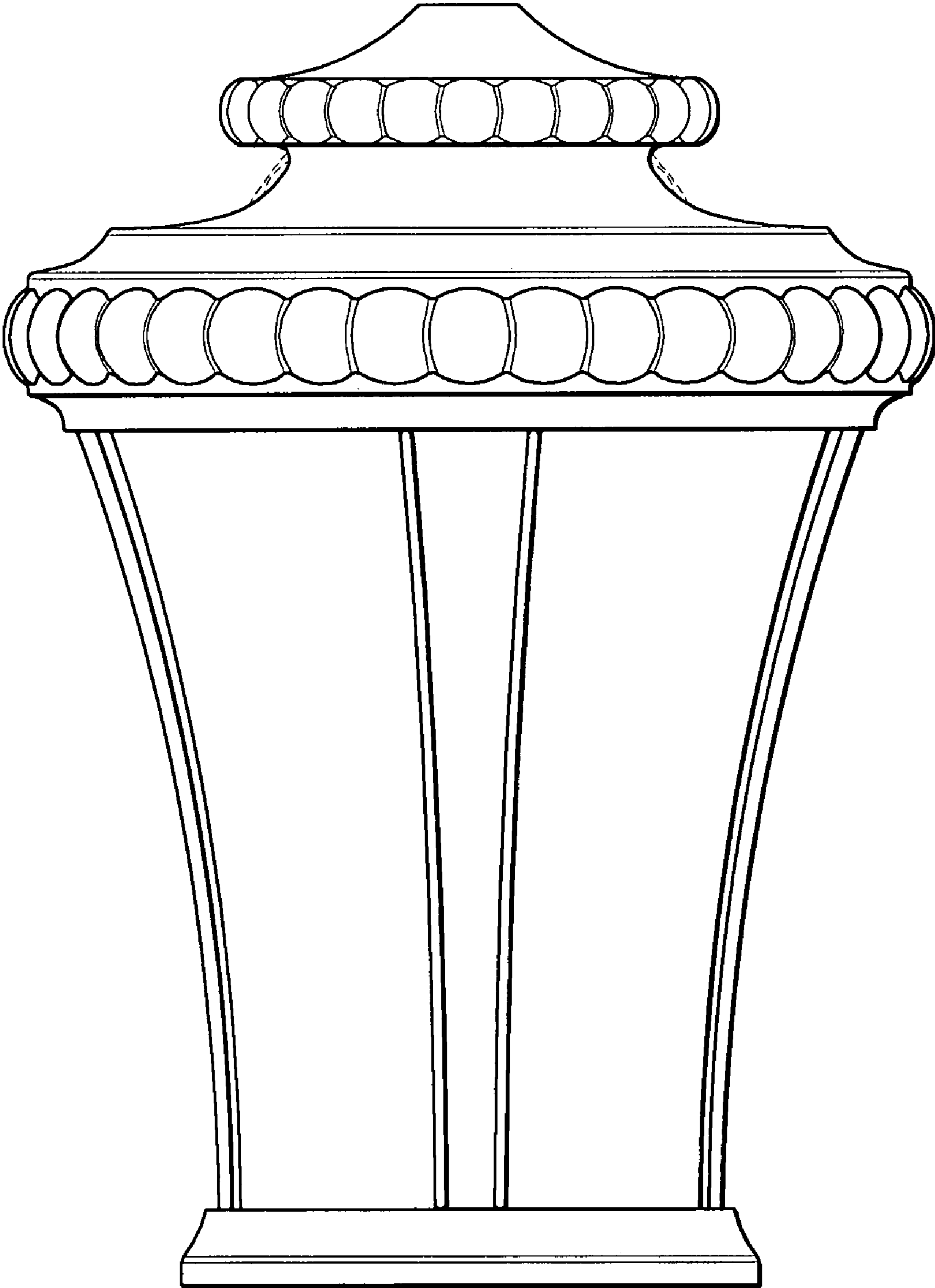
The broken lines shown on the drawings are for illustrative purposes only and form no part of the claimed design.

**1 Claim, 6 Drawing Sheets**

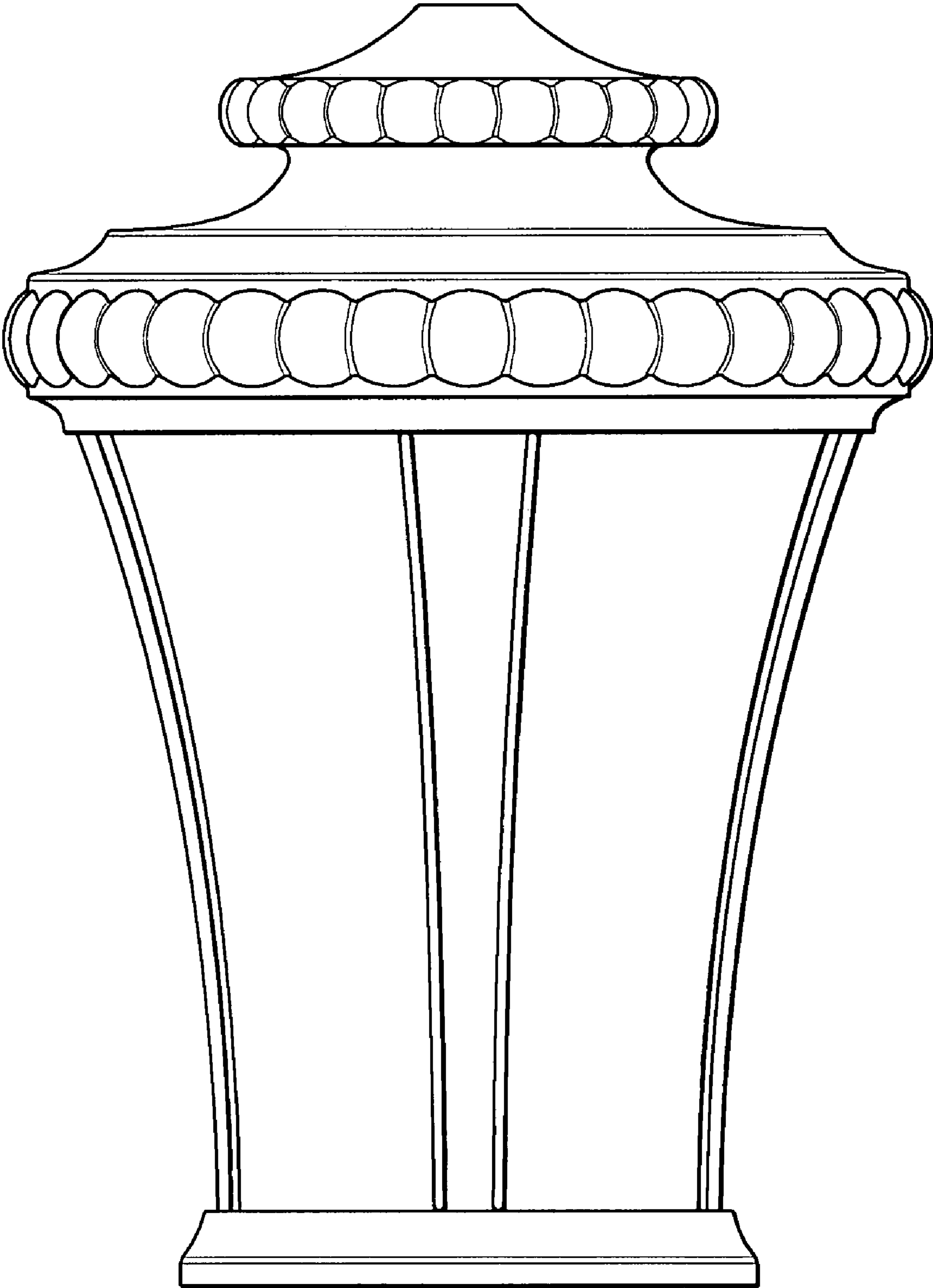


*FIG. 1*



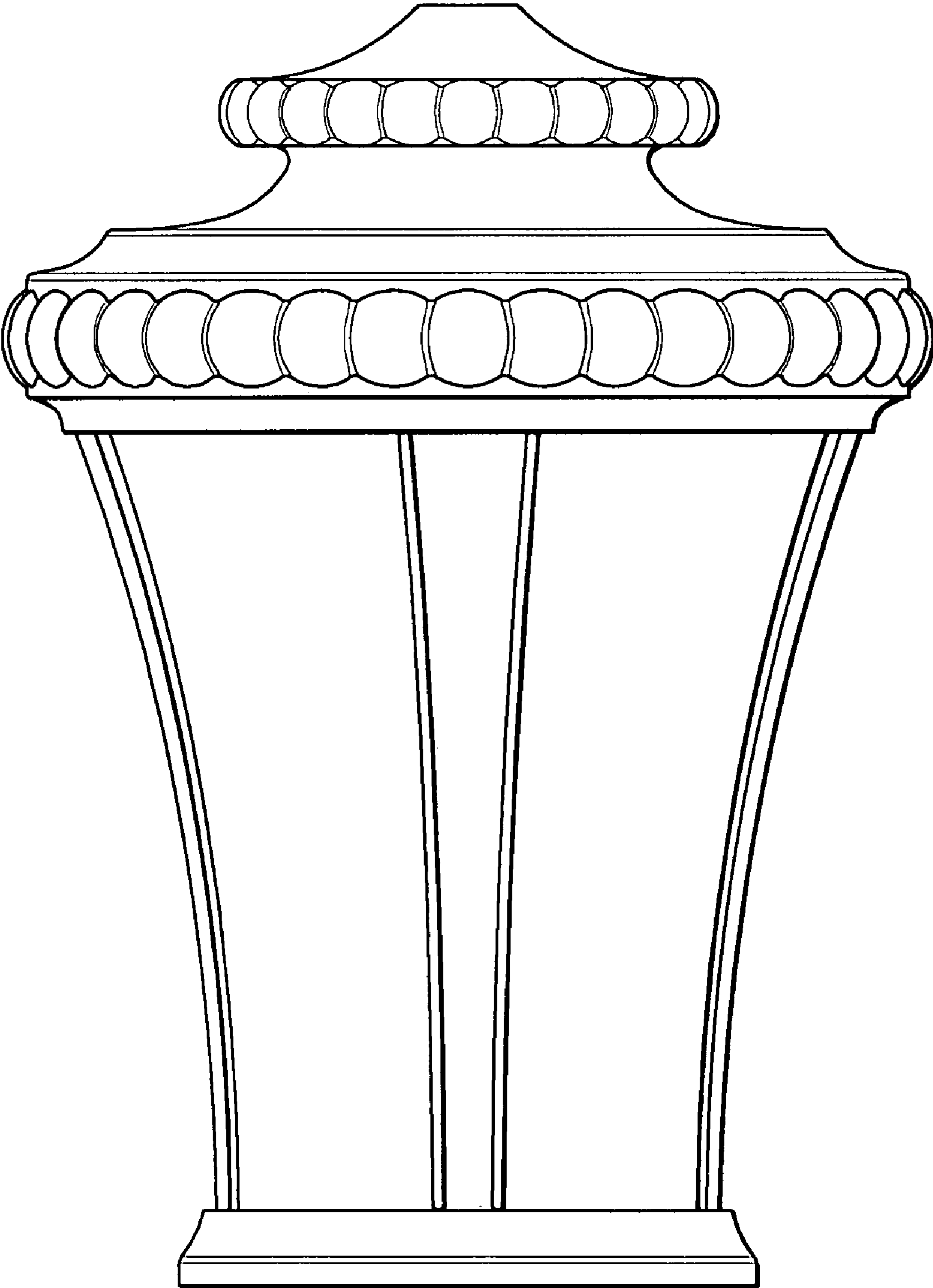


*FIG. 2*



*FIG. 3*





*FIG. 4*

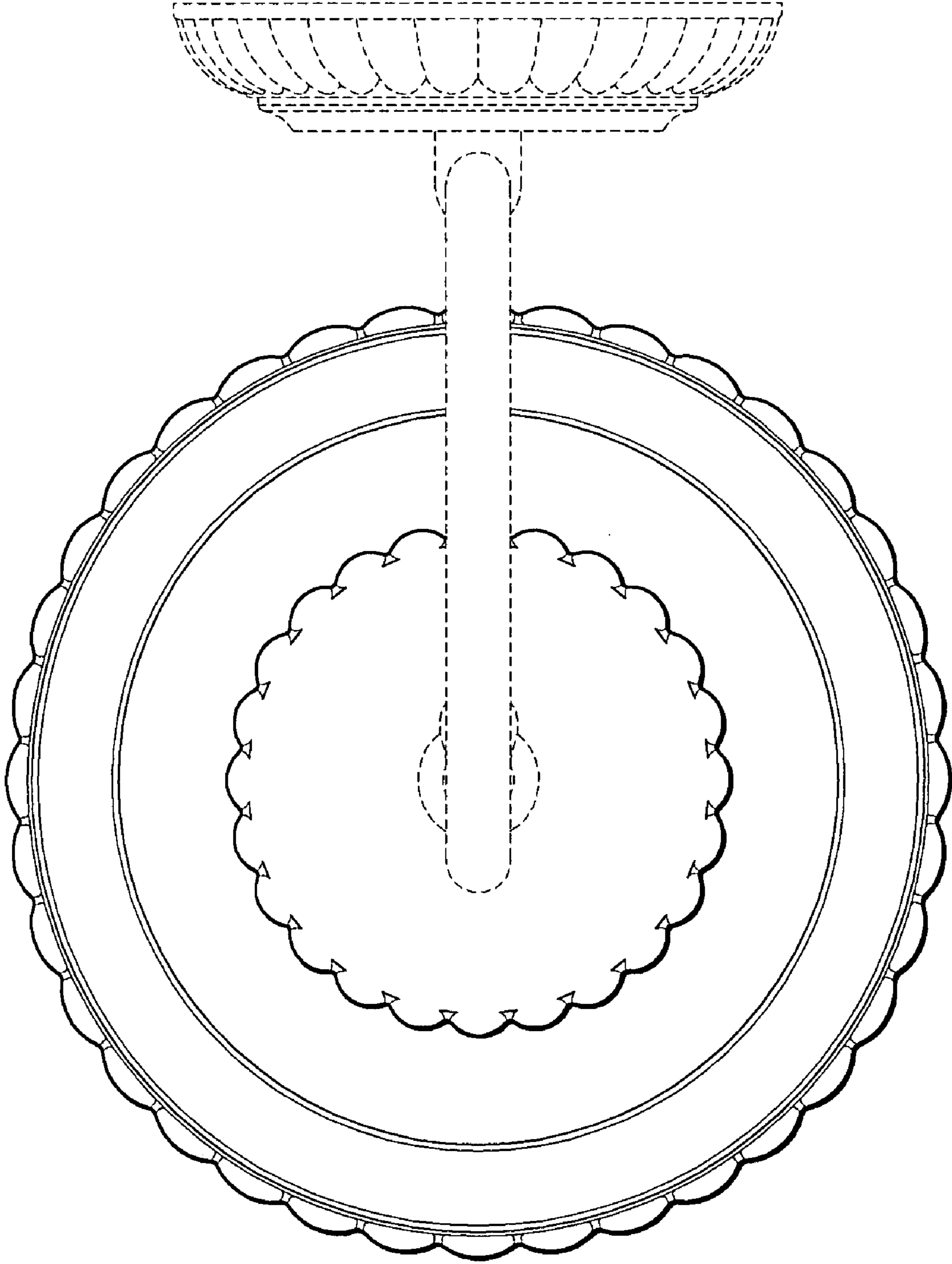
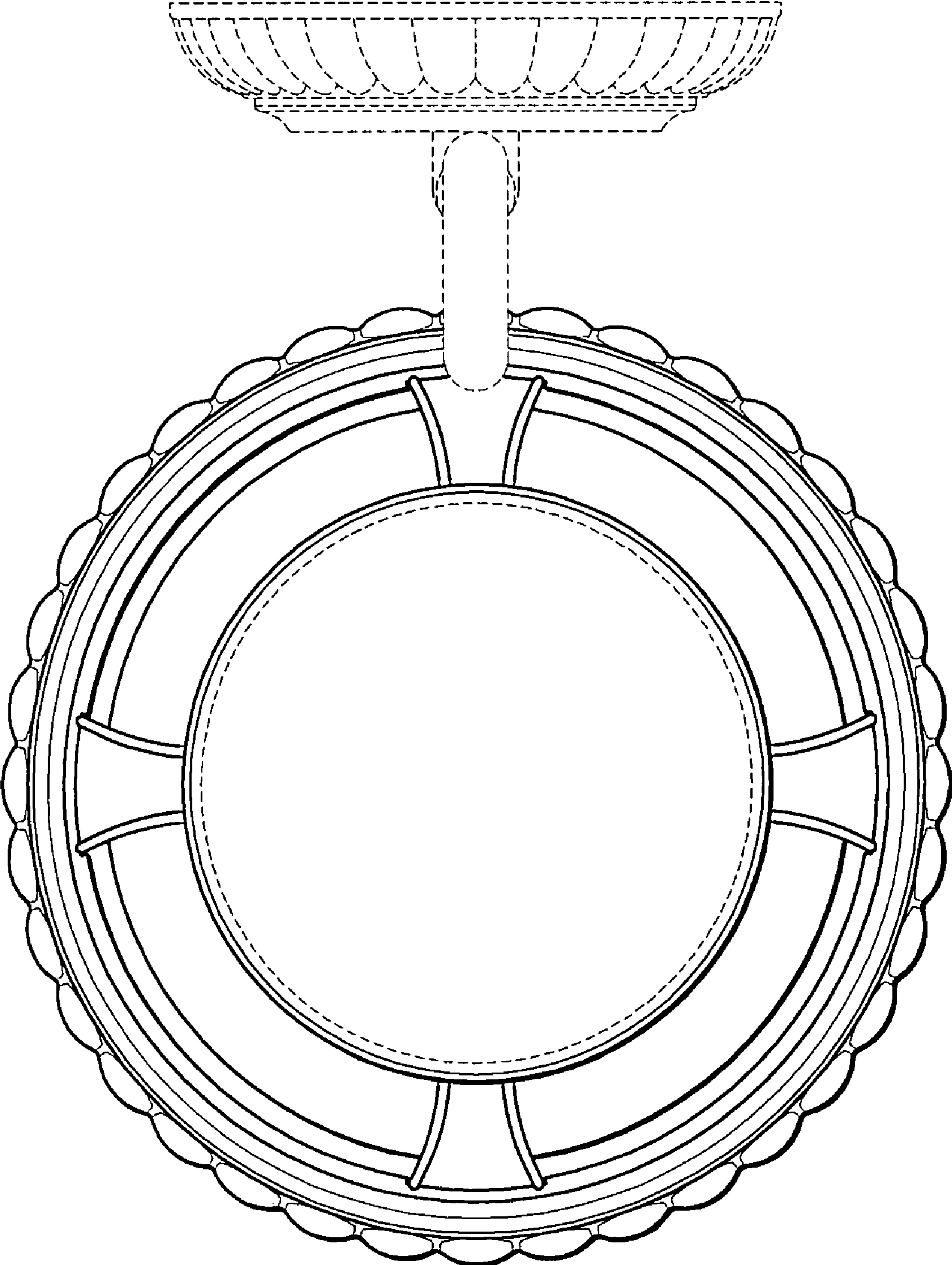


FIG. 5



*FIG. 6*