

US00D569962S

(12) **United States Design Patent**
Nishio et al.

(10) **Patent No.:** **US D569,962 S**

(45) **Date of Patent:** **** May 27, 2008**

- (54) **AIR-CONDITIONING DUCT WITH FAN**
- (75) Inventors: **Toshiyuki Nishio**, Kusatsu (JP); **Junji Nakamura**, Kusatsu (JP); **Manabu Katou**, Kusatsu (JP); **Kaichi Tsuji**, Kusatsu (JP); **Yuuichi Murai**, Kusatsu (JP); **Kouichirou Seki**, Kusatsu (JP); **Kentarou Niki**, Kusatsu (JP); **Dai Satou**, Kusatsu (JP); **Yumi Ohta**, Kusatsu (JP); **Hiroko Kashimoto**, Kusatsu (JP); **Masahiko Chouji**, Kusatsu (JP)

D536,430 S *	2/2007	Miyake et al.	D23/351
D539,884 S *	4/2007	Shimizu	D23/351
D539,889 S *	4/2007	Chooji et al.	D23/351
D550,822 S *	9/2007	Shimizu	D23/351
D550,823 S *	9/2007	Nakamura	D23/351
D553,721 S *	10/2007	Seki et al.	D23/351
D553,722 S *	10/2007	Seki et al.	D23/351
D553,723 S *	10/2007	Nakamura et al.	D23/351
D553,724 S *	10/2007	Nakamura	D23/351
D553,726 S *	10/2007	Niki	D23/351
D556,880 S *	12/2007	Choi et al.	D23/351
D558,318 S *	12/2007	Choi et al.	D23/351
D558,866 S *	1/2008	Yamamoto	D23/351

(73) Assignee: **Daikin Industries Ltd.**, Osaka (JP)

* cited by examiner

(**) Term: **14 Years**

Primary Examiner—Louis S Zarfaz

Assistant Examiner—David G Muller

(21) Appl. No.: **29/290,185**

(74) *Attorney, Agent, or Firm*—Manabu Kanesaka

(22) Filed: **Nov. 1, 2007**

(57) **CLAIM**

(51) **LOC (8) Cl.** **23-04**

The ornamental design for an air-conditioning duct with fan, as shown and described.

(52) **U.S. Cl.** **D23/393**

(58) **Field of Classification Search** D23/351, D23/393, 388, 389, 385, 370, 354, 386, 355, D23/357, 361, 387; 454/309, 275–277, 284, 454/287–291; D26/76

DESCRIPTION

See application file for complete search history.

FIG. 1 is a perspective view of an air-conditioning duct with fan showing our new design;

FIG. 2 is a front view thereof;

FIG. 3 is a rear view thereof;

FIG. 4 is a plan view thereof;

FIG. 5 is a bottom view thereof;

FIG. 6 is a right side view thereof; and,

FIG. 7 is a left side view thereof.

(56) **References Cited**

U.S. PATENT DOCUMENTS

D384,735 S *	10/1997	Saccone	D23/351
D465,837 S *	11/2002	Hatanaka et al.	D23/351
D495,047 S *	8/2004	Gilbert	D23/387
D529,156 S *	9/2006	Murai	D23/351
D529,595 S *	10/2006	Ueno et al.	D23/351

1 Claim, 6 Drawing Sheets

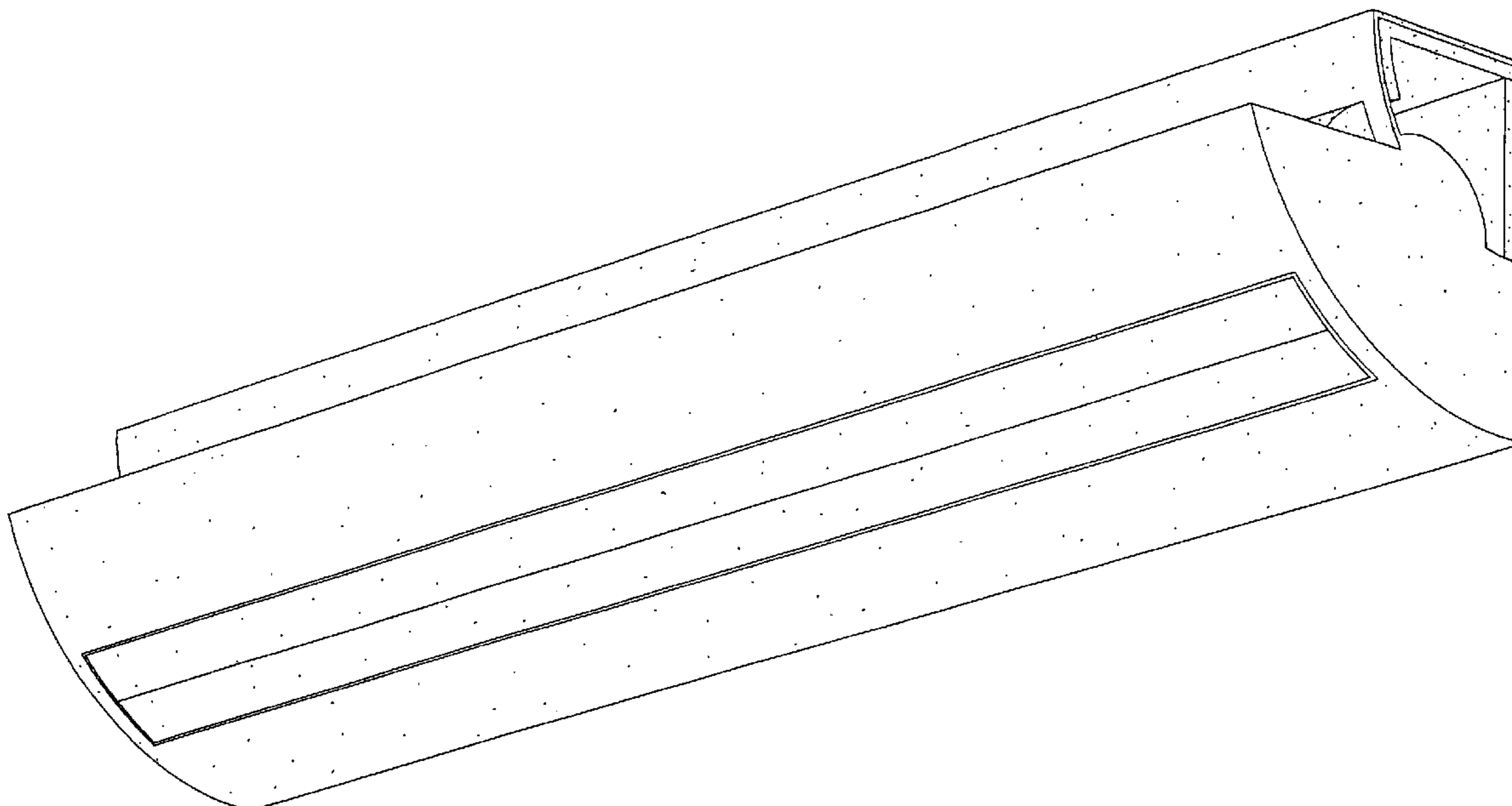

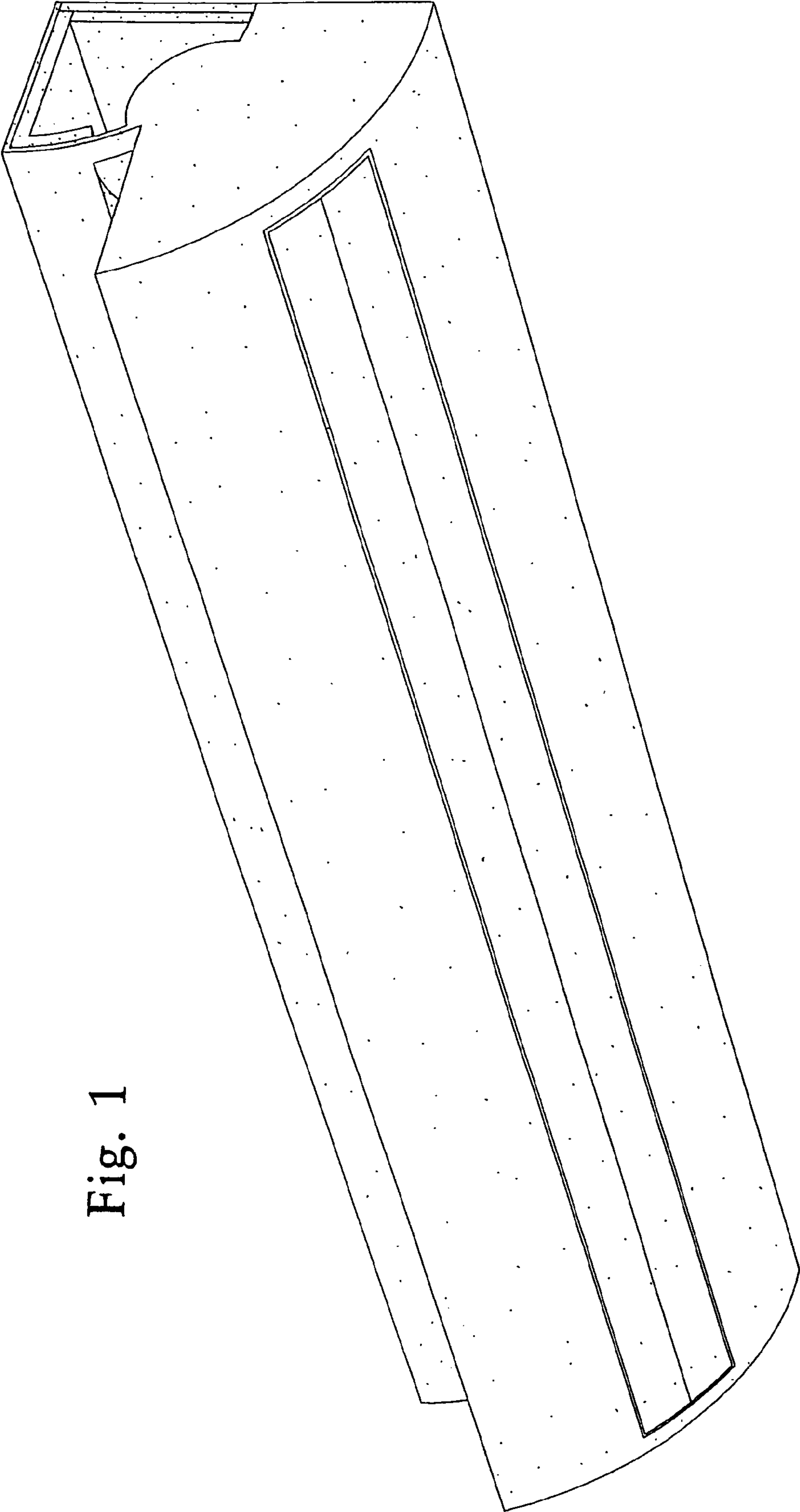

Fig. 1

Fig. 2

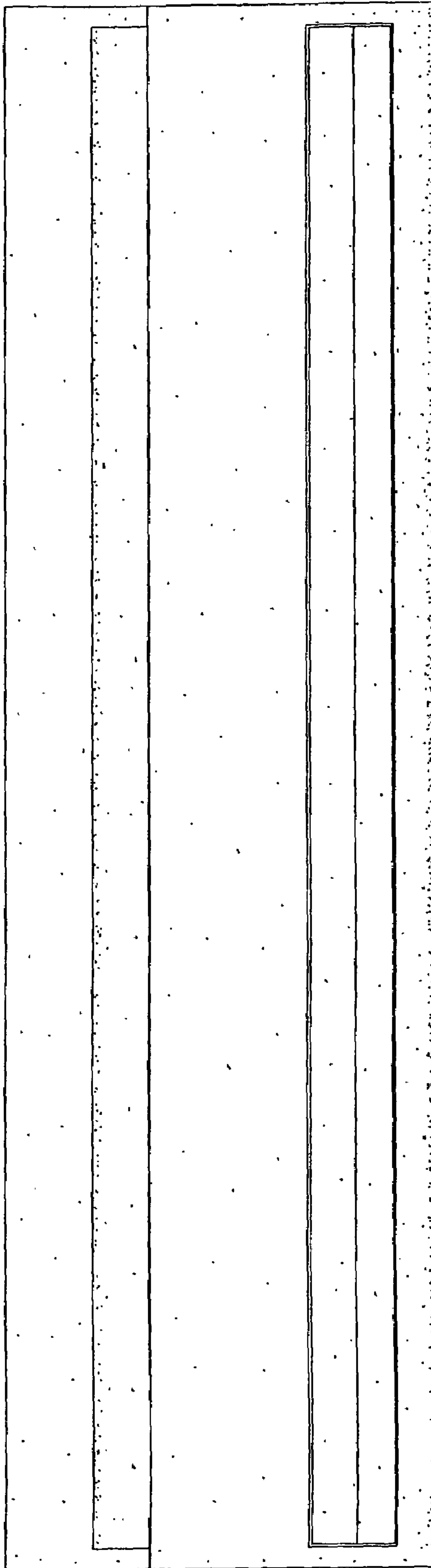

Fig. 3

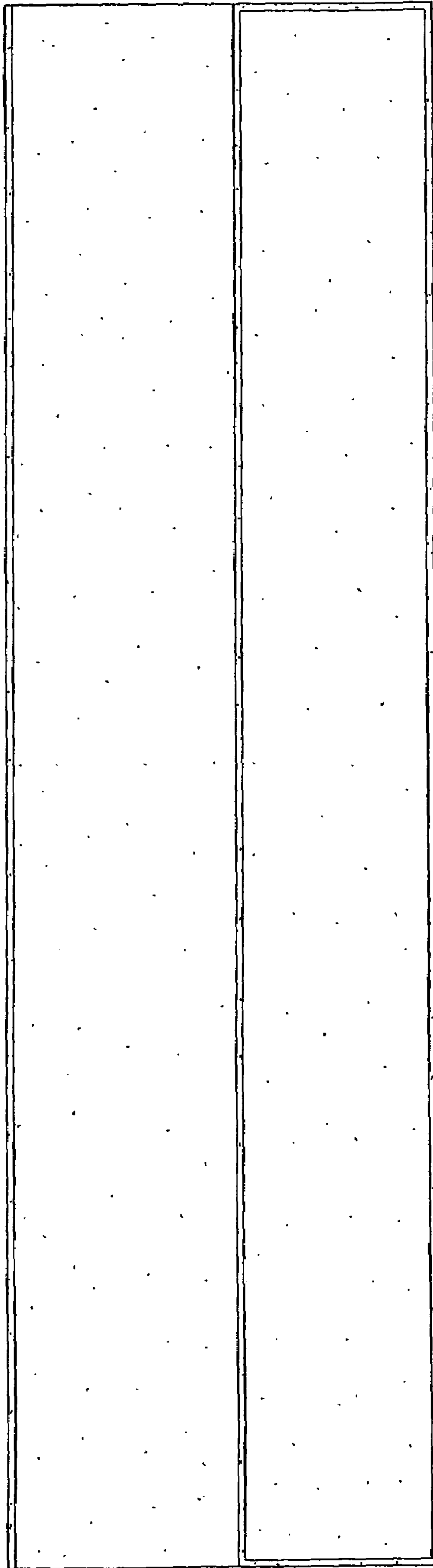

Fig. 4

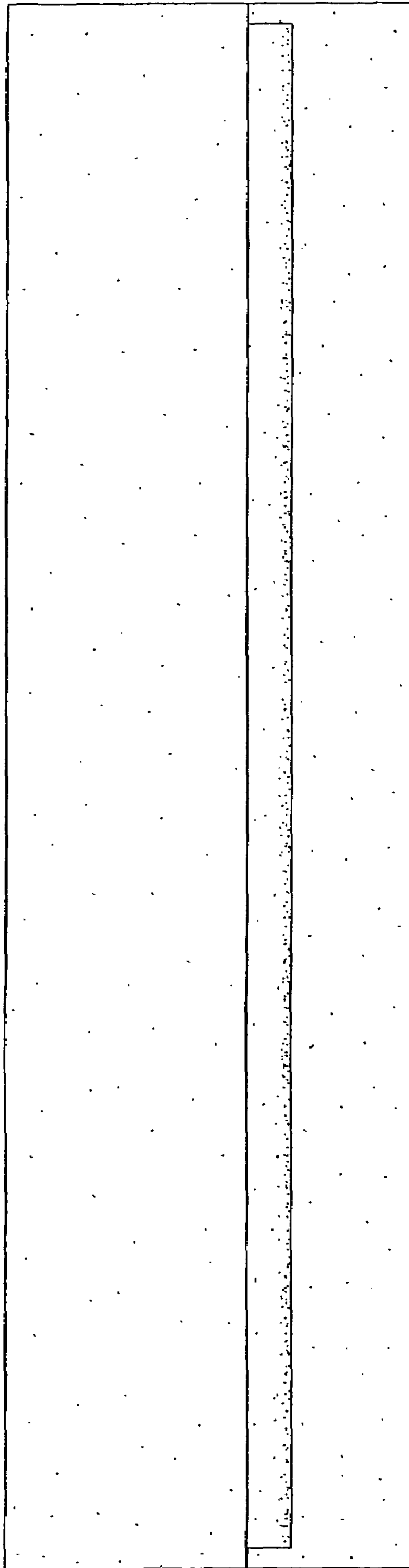

Fig. 5

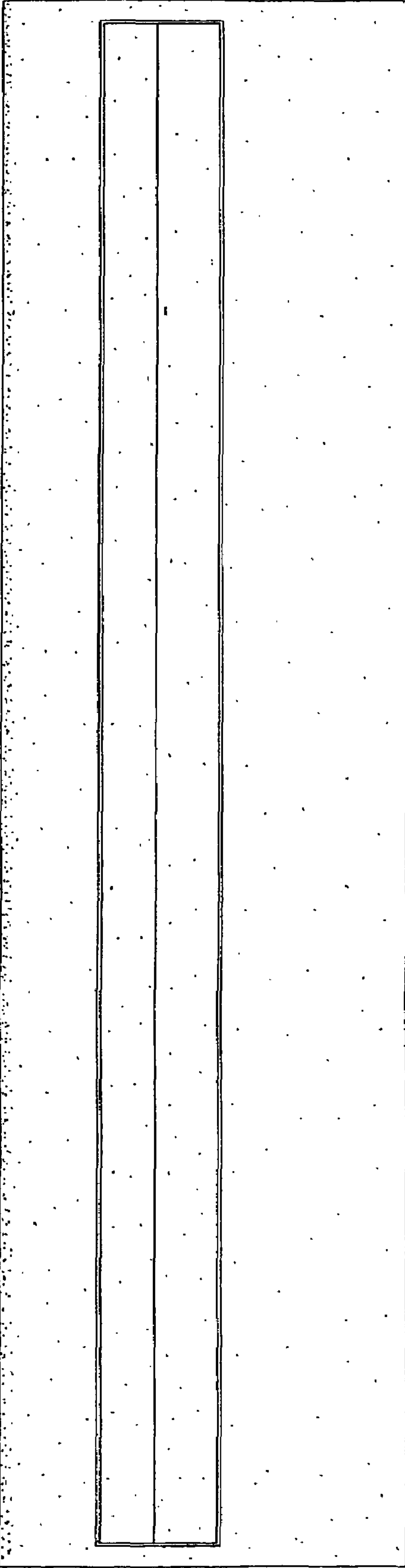

Fig. 7

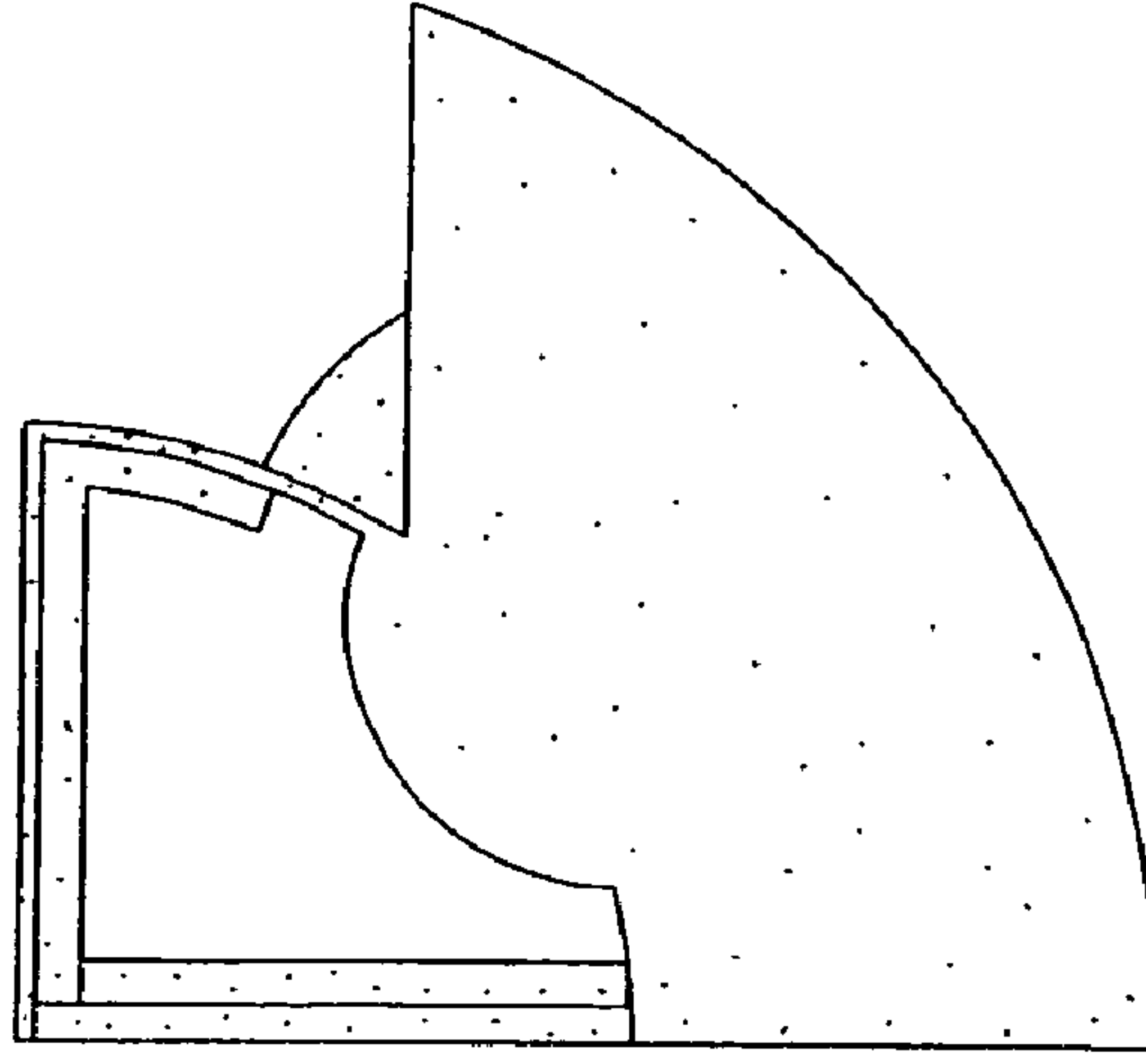

Fig. 6

