



US00D569960S

(12) **United States Design Patent**
Lewis

(10) **Patent No.:** **US D569,960 S**

(45) **Date of Patent:** **** May 27, 2008**

(54) **BODY FOR A PORTABLE FAN**

D553,718 S * 10/2007 Shapiro et al. D23/314

* cited by examiner

(75) Inventor: **William Lewis**, Denver, PA (US)

Primary Examiner—Lisa Lichtenstein

(73) Assignee: **Lasko Holdings Inc.**, Wilmington, DE (US)

(74) *Attorney, Agent, or Firm*—Martin Fruitman

(**) Term: **14 Years**

(57) **CLAIM**

(21) Appl. No.: **29/291,911**

The ornamental design for a body for a portable fan, as shown and described.

(22) Filed: **Sep. 20, 2007**

DESCRIPTION

(51) **LOC (8) Cl.** **23-04**

FIG. 1 is a right side front perspective view of a body for a portable fan showing my new design;

(52) **U.S. Cl.** **D23/378**

FIG. 2 is a right side rear perspective view thereof;

(58) **Field of Classification Search** D23/378,
D23/332, 381, 335, 337, 336, 370, 382; 416/246,
416/247 R

FIG. 3 is a front elevation view thereof;

See application file for complete search history.

FIG. 4 is a right side elevation view thereof;

FIG. 5 is a left side elevation view thereof;

(56) **References Cited**

FIG. 6 is a rear elevation view thereof; and,

U.S. PATENT DOCUMENTS

FIG. 7 is an enlarged top plan view thereof.

D329,284 S * 9/1992 Patton D23/378

The broken line showing of the front grill, side grills, top button, upper rear rectangular indentation and bottom stand is included for the purpose of illustrating environmental structure and forms no part of the claimed design.

D486,216 S * 2/2004 Wilson, Jr. D23/378

D512,773 S * 12/2005 Lee D23/378

D528,202 S * 9/2006 Shapiro D23/411

D531,300 S * 10/2006 Dooley D23/378

1 Claim, 7 Drawing Sheets

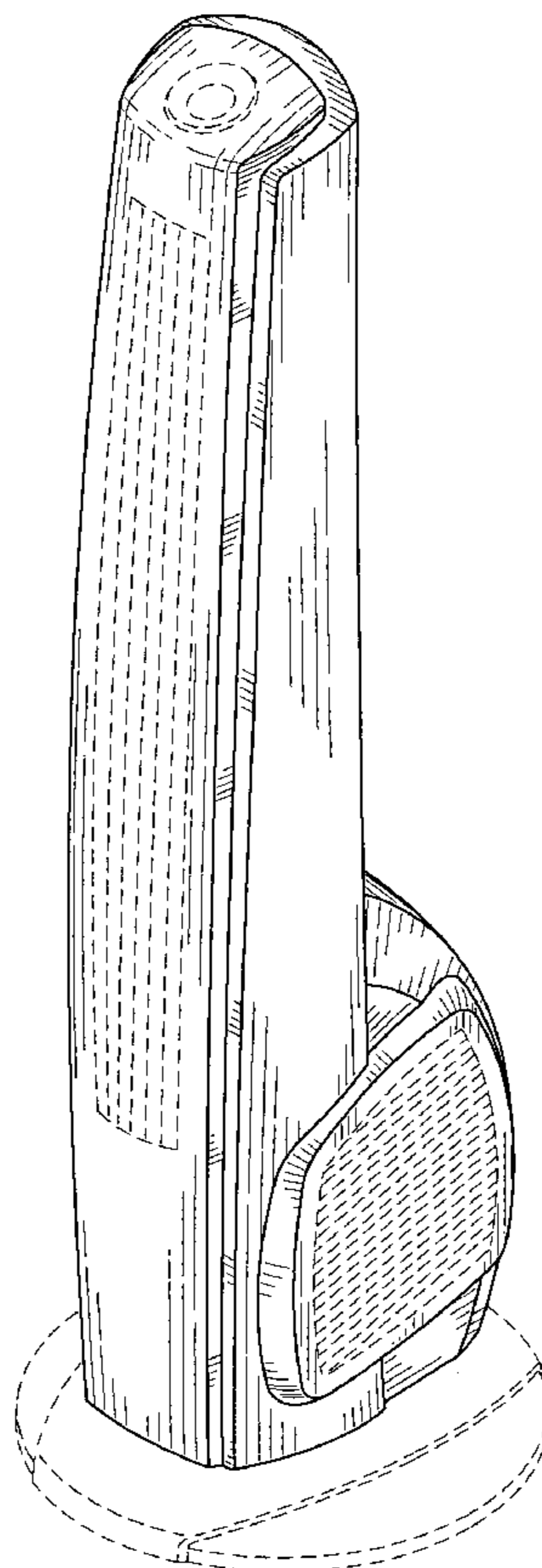

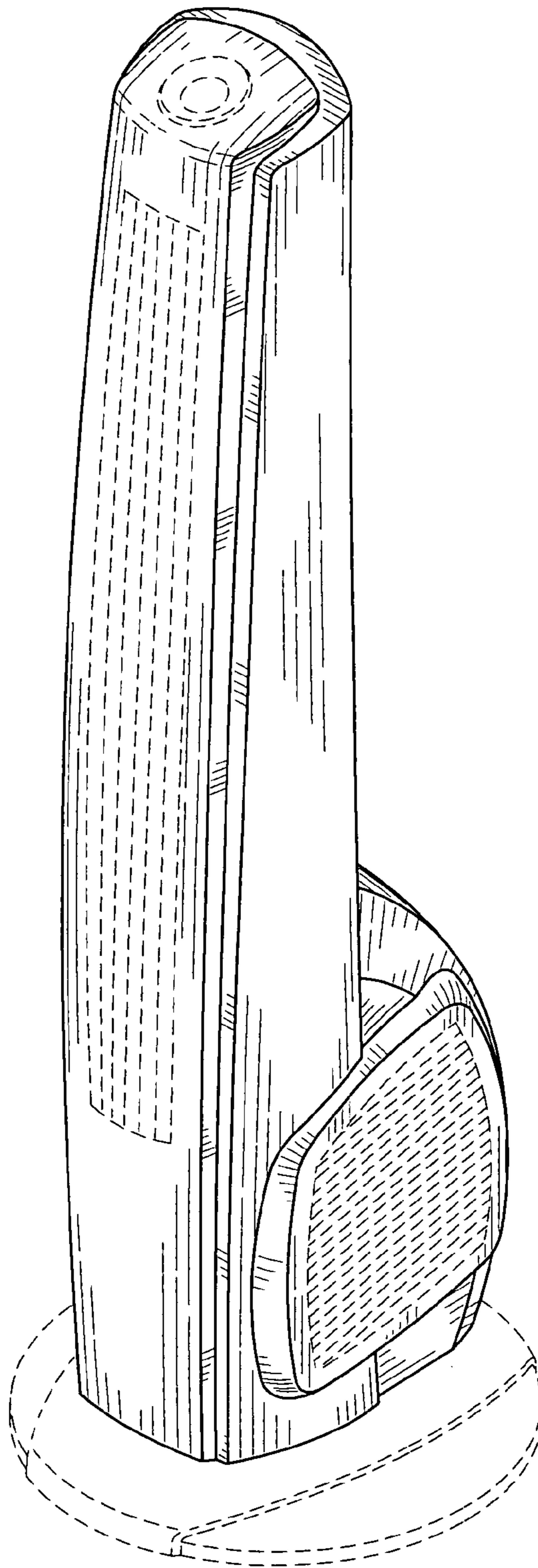

FIG. 1

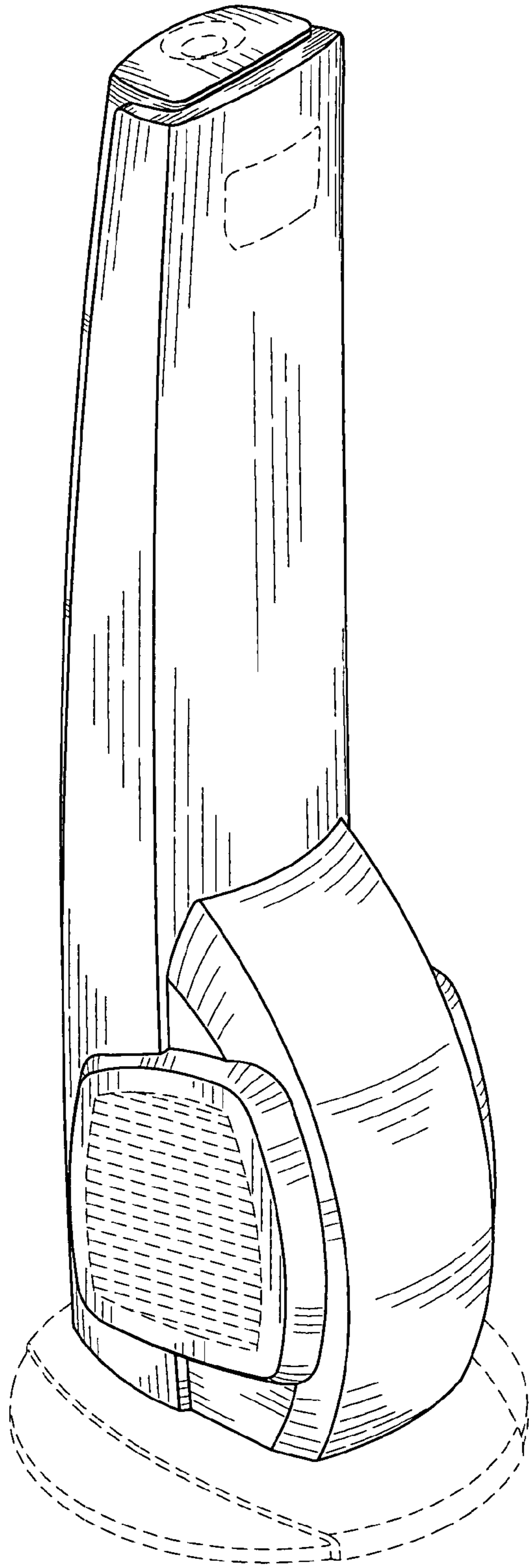

FIG. 2

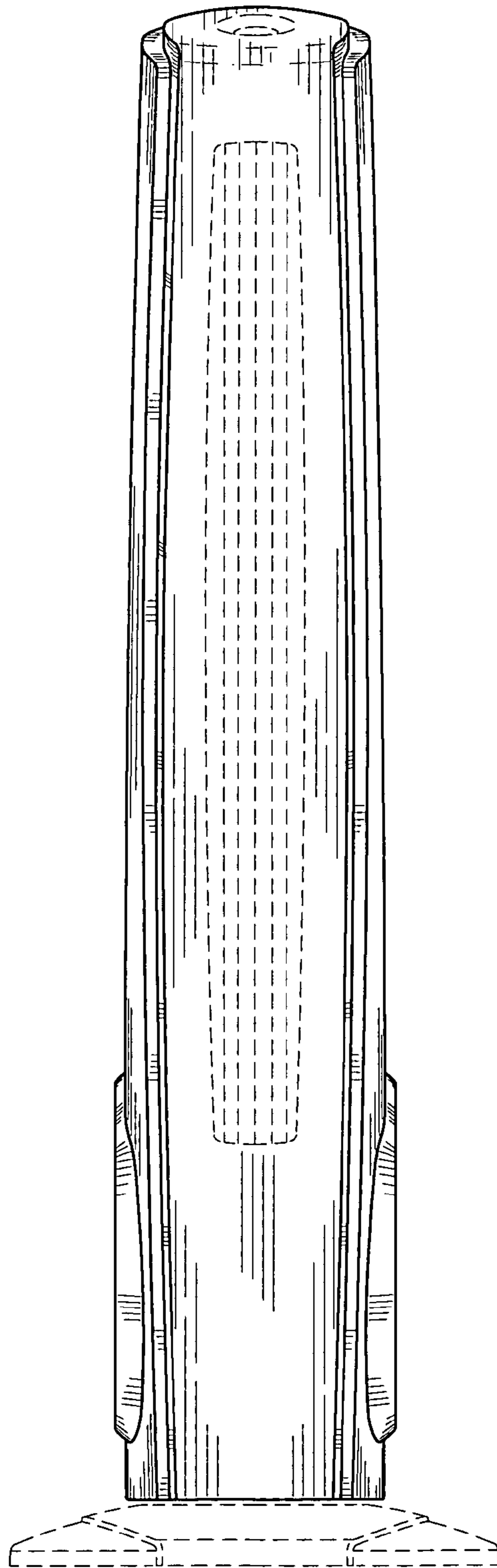

FIG. 3

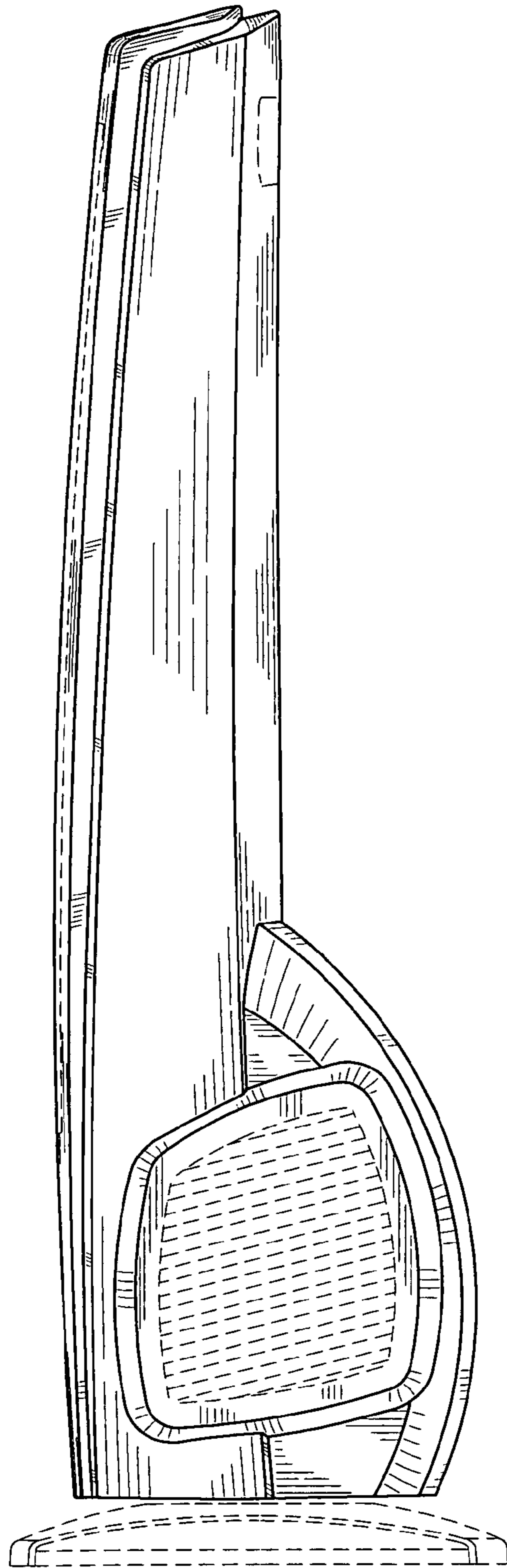

FIG. 4

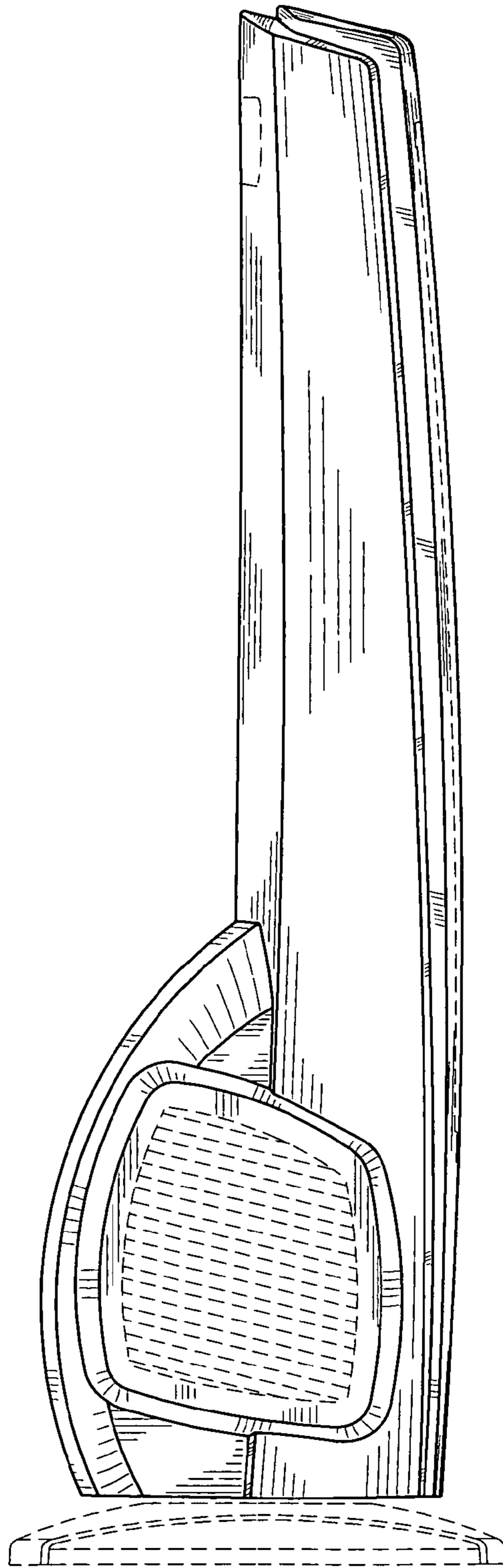

FIG. 5

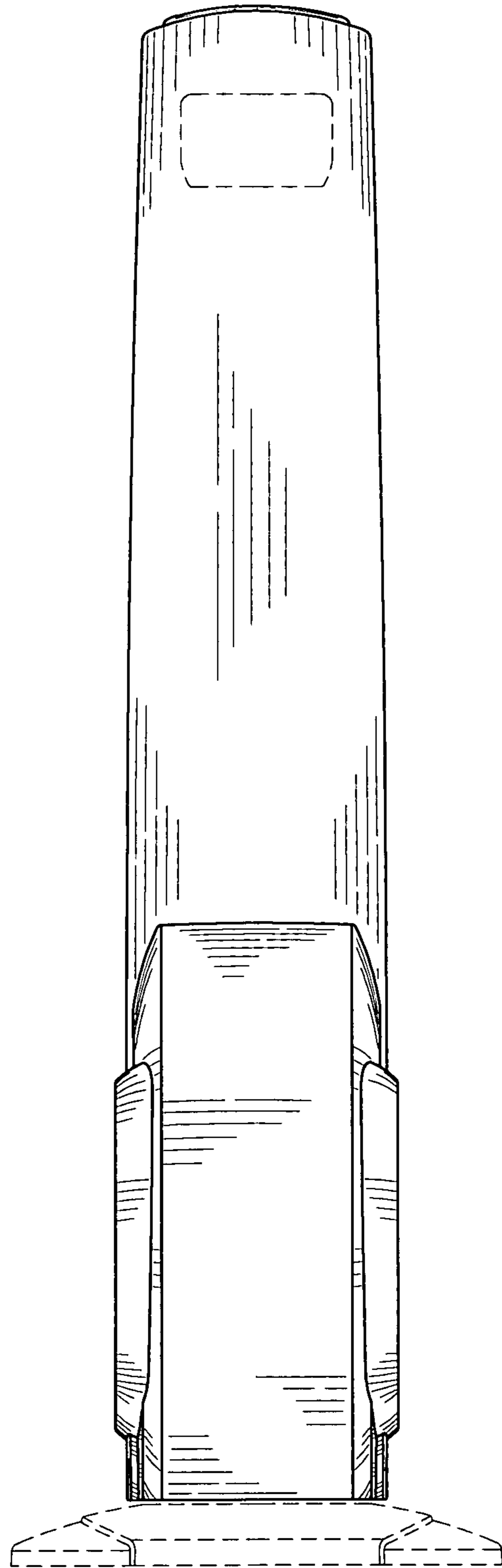

FIG. 6

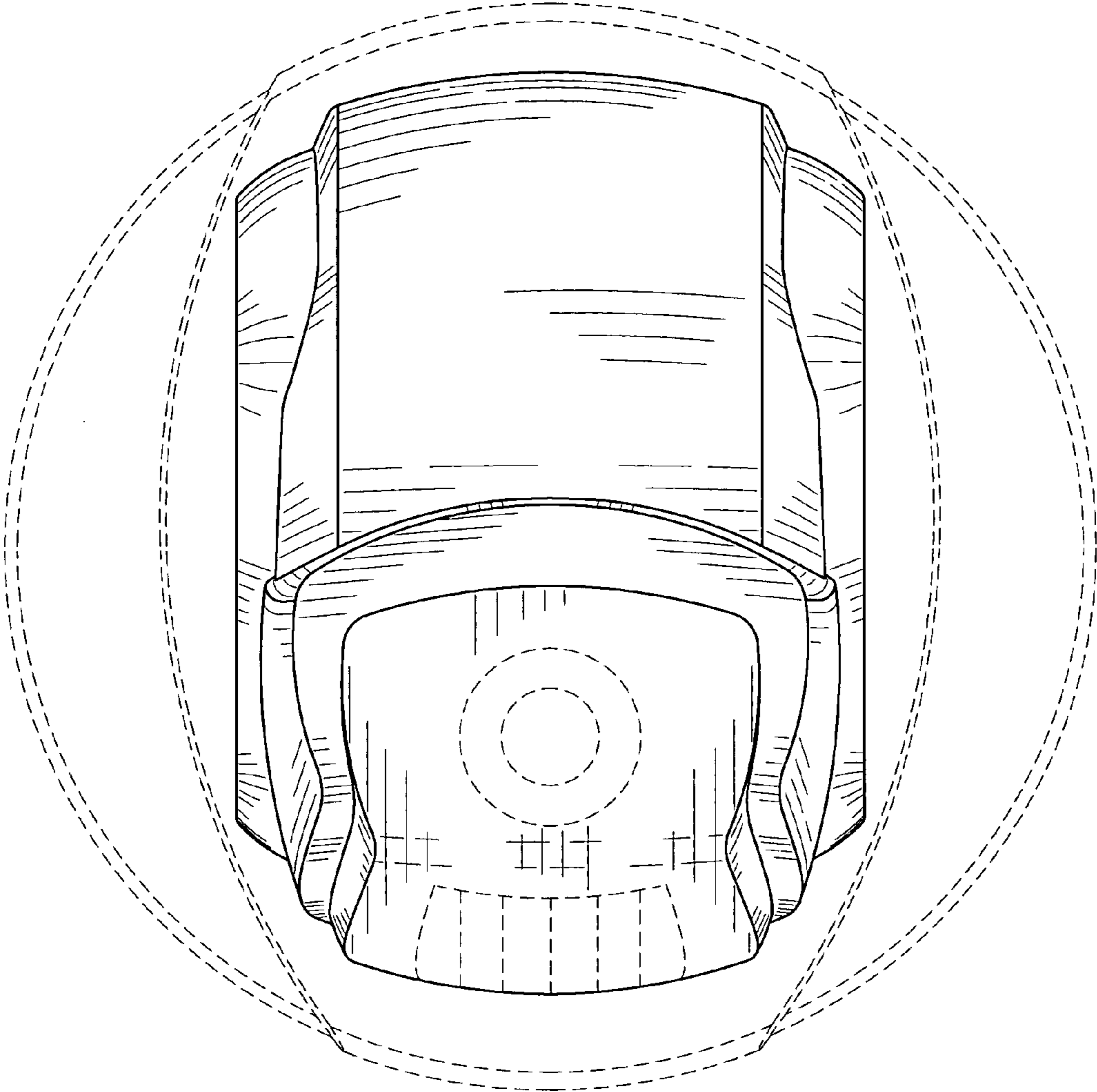

FIG. 7