



US00D569937S

(12) **United States Design Patent**  
**Sanchez et al.**

(10) **Patent No.:** **US D569,937 S**

(45) **Date of Patent:** **\*\* May 27, 2008**

(54) **GOLF DRIVER HEAD**

(75) Inventors: **Richard R. Sanchez**, New River, AZ  
(US); **Xiaojian Chen**, Phoenix, AZ  
(US); **Frank A. Quartarone**, Phoenix,  
AZ (US)

(73) Assignee: **Karsten Manufacturing Corporation**,  
Phoenix, AZ (US)

(\*\*) Term: **14 Years**

(21) Appl. No.: **29/281,293**

(22) Filed: **Jun. 20, 2007**

(51) **LOC (8) Cl.** ..... **21-02**

(52) **U.S. Cl.** ..... **D21/752**

(58) **Field of Classification Search** ..... D21/733,  
D21/752, 759; 473/324–331, 343–346  
See application file for complete search history.

(56) **References Cited**

U.S. PATENT DOCUMENTS

D482,089 S *	11/2003	Burrows	.....	D21/752
D482,420 S *	11/2003	Burrows	.....	D21/752
D484,208 S *	12/2003	Burrows	.....	D21/752
D501,036 S *	1/2005	Burrows	.....	D21/752
D514,179 S *	1/2006	Chen et al.	.....	D21/733
D522,077 S *	5/2006	Schweigert et al.	.....	D21/752
D522,597 S	6/2006	Sanchez		
D522,601 S *	6/2006	Schweigert et al.	.....	D21/752
D523,498 S *	6/2006	Chen et al.	.....	D21/733
D526,694 S	8/2006	Schweigert et al.		
D532,473 S *	11/2006	Chen et al.	.....	D21/759
D535,343 S	1/2007	Chen et al.		
D537,495 S *	2/2007	Schweigert et al.	.....	D21/752
D537,496 S	2/2007	Serrano et al.		
D538,363 S	3/2007	Schweigert et al.		
D539,371 S	3/2007	Chen et al.		
D552,198 S *	10/2007	Schweigert et al.	.....	D21/752
D557,363 S *	12/2007	Jertson et al.	.....	D21/752
D558,287 S *	12/2007	Jertson et al.	.....	D21/752
D558,288 S *	12/2007	Jertson et al.	.....	D21/752
D561,284 S *	2/2008	Nagai et al.	.....	D21/759

D561,859 S *	2/2008	Haralson et al.	.....	D21/759
D562,421 S *	2/2008	Jertson et al.	.....	D21/752
D562,422 S *	2/2008	Roberts et al.	.....	D21/759
D562,926 S *	2/2008	Roberts et al.	.....	D21/759
D564,055 S *	3/2008	Jertson et al.	.....	D21/752
D564,056 S *	3/2008	Chen et al.	.....	D21/759
D564,611 S *	3/2008	Llewellyn et al.	.....	D21/759

OTHER PUBLICATIONS

Bradley D. Schweigert, et al., "Golf Driver Head," U.S. Appl. No. 29/239,853, filed Oct. 4, 2005.  
Anthony D. Serrano, et al., "Golf Driver Head," U.S. Appl. No. 29/266,936, filed Sep. 29, 2006.  
Eric J. Morales, et al., "Golf Driver Head," U.S. Appl. No. 29/266,927, filed Sep. 29, 2006.  
Marty R. Jertson, et al., "Golf Fairway Wood Head," U.S. Appl. No. 29/277,584, filed Mar. 2, 2007.

(Continued)

*Primary Examiner*—Mitchell I Siegel

(57) **CLAIM**

The ornamental design for a golf driver head, as shown and described.

**DESCRIPTION**

FIG. 1 is a top perspective view of the golf driver head;  
FIG. 2 is a bottom perspective view of the golf driver head of FIG. 1;  
FIG. 3 is a front elevational view of the golf driver head of FIG. 1;  
FIG. 4 is a rear elevational view of the golf driver head of FIG. 1;  
FIG. 5 is a top view of the golf driver head of FIG. 1;  
FIG. 6 is a bottom view of the golf driver head of FIG. 1;  
FIG. 7 is a heel end view of the golf driver head of FIG. 1; and,  
FIG. 8 is a toe end view of the golf driver head of FIG. 1.  
The broken lines shown in FIGS. 1, 2, 3, 4, 5, 6, 7, and 8 are for illustrative purposes only and form no part of the claimed design.

**1 Claim, 4 Drawing Sheets**

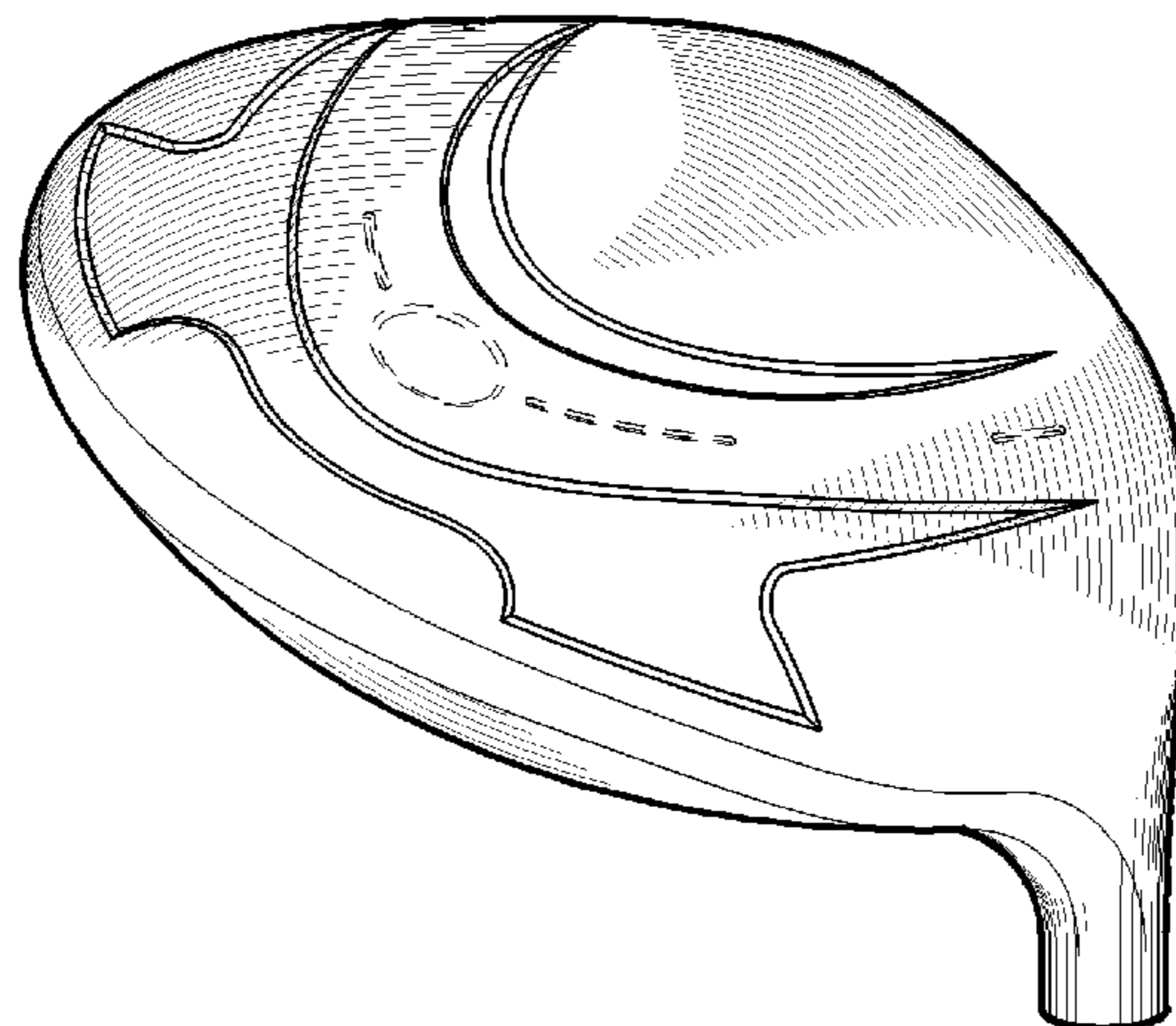

OTHER PUBLICATIONS

Marty R. Jertson, et al., "Golf Fairway Wood Head," U.S. Appl. No. 29/277,590, filed Mar. 2, 2007.  
Marty R. Jertson, et al., "Golf Fairway Wood Head," U.S. Appl. No. 29/277,591, filed Mar. 2, 2007.  
Marty R. Jertson, et al., "Golf Hybrid Head," U.S. Appl. No. 29/277,182, filed Feb. 16, 2007.  
Bradley D. Schweigert, et al., "Golf Driver Head," U.S. Appl. No. 29/277,593, filed Mar. 2, 2007.  
Bradley D. Schweigert, et al., "Golf Driver Head," U.S. Appl. No. 29/277,595, filed Mar. 2, 2007.  
Bradley D. Schweigert, et al., "Golf Driver Head," U.S. Appl. No. 29/277,594, filed Mar. 2, 2007.  
Marty R. Jertson, et al., "Golf Hybrid Head," U.S. Appl. No. 29/277,597, filed Mar. 2, 2007.  
Marty R. Jertson, et al., "Golf Hybrid Head," U.S. Appl. No. 29/277,586, filed Mar. 2, 2007.  
Marty R. Jertson, et al., "Golf Hybrid Head," U.S. Appl. No. 29/277,587, filed Mar. 2, 2007.  
Marty R. Jertson, et al., "Golf Hybrid Head," U.S. Appl. No. 29/277,177, filed Feb. 16, 2007.  
Marty R. Jertson, et al., "Sole for Golf Club Head," U.S. Appl. No. 29/280,086, filed May 16, 2007.  
Richard R. Sanchez, et al., "Golf Driver Head," U.S. Appl. No. 29/281,298, filed Jun. 20, 2007.

Richard R. Sanchez, et al., "Golf Fairway Wood Head," U.S. Appl. No. 29/281,303, filed Jun. 20, 2007.  
Richard R. Sanchez, et al., "Golf Fairway Wood Head," U.S. Appl. No. 29/281,310, filed Jun. 20, 2007.  
Richard R. Sanchez, et al., "Golf Hybrid Head," U.S. Appl. No. 29/281,316, filed Jun. 20, 2007.  
Richard R. Sanchez, et al., "Golf Hybrid Head," U.S. Appl. No. 29/281,317, filed Jun. 20, 2007.  
Richard R. Sanchez, et al., "Golf Driver Head," U.S. Appl. No. 29/281,325, filed Jun. 20, 2007.  
Richard R. Sanchez, et al., "Golf Driver Head," U.S. Appl. No. 29/281,327, filed Jun. 20, 2007.  
Richard R. Sanchez, et al., "Golf Hybrid Head," U.S. Appl. No. 29/281,320, filed Jun. 20, 2007.  
Richard R. Sanchez, et al., "Golf Hybrid Head," U.S. Appl. No. 29/281,323, filed Jun. 20, 2007.  
Richard R. Sanchez, et al., "Sole for a Golf Club Head," U.S. Appl. No. 29/281,329, filed Jun. 20, 2007.  
Richard R. Sanchez, et al., "Sole for a Golf Club Head," U.S. Appl. No. 29/281,332, filed Jun. 20, 2007.  
Richard R. Sanchez, et al., "Sole for a Golf Club Head," U.S. Appl. No. 29/281,336, filed Jun. 20, 2007.  
Richard R. Sanchez, et al., "Sole for a Golf Club Head," U.S. Appl. No. 29/281,337, filed Jun. 20, 2007.

\* cited by examiner

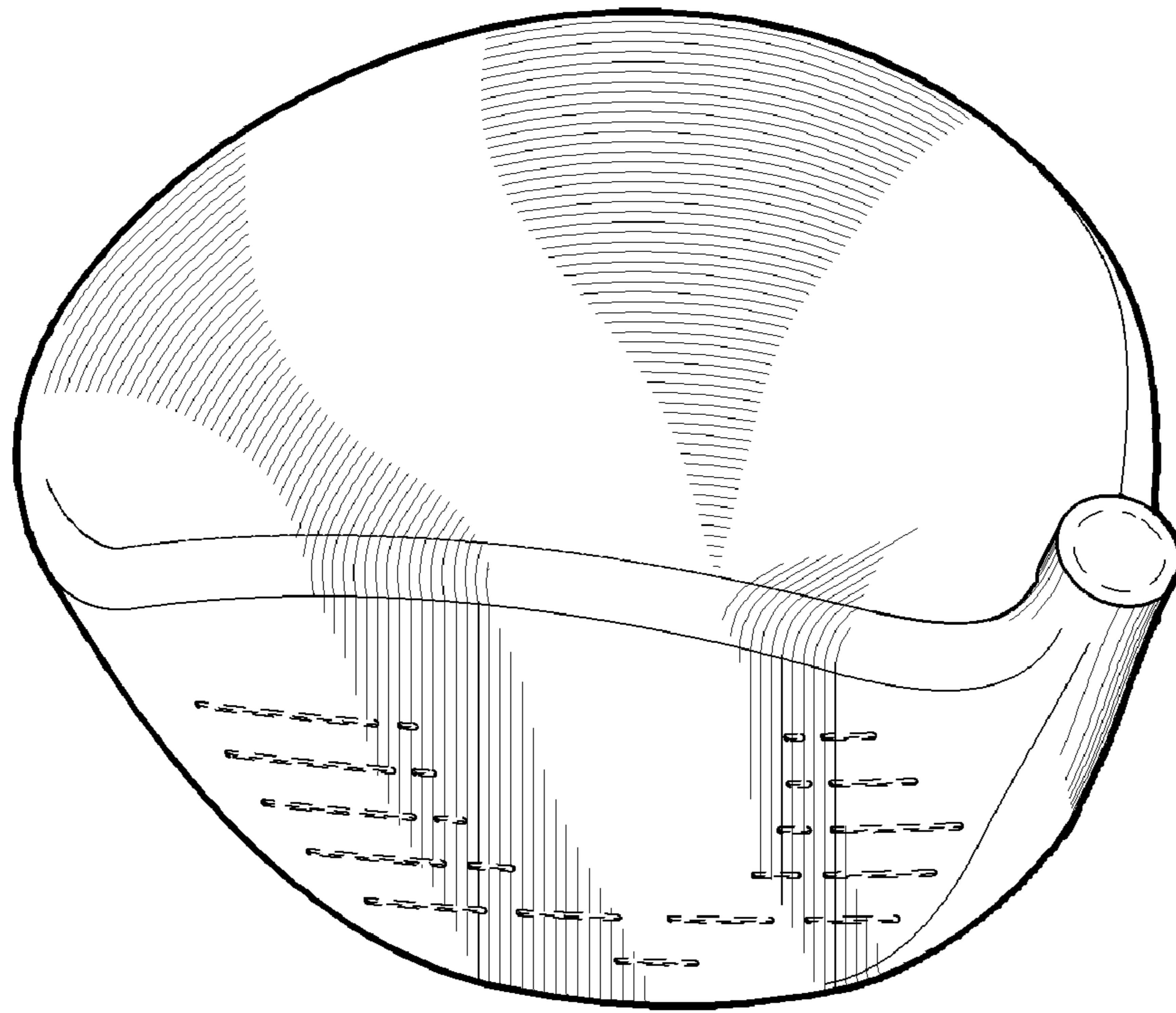

*Fig. 1*

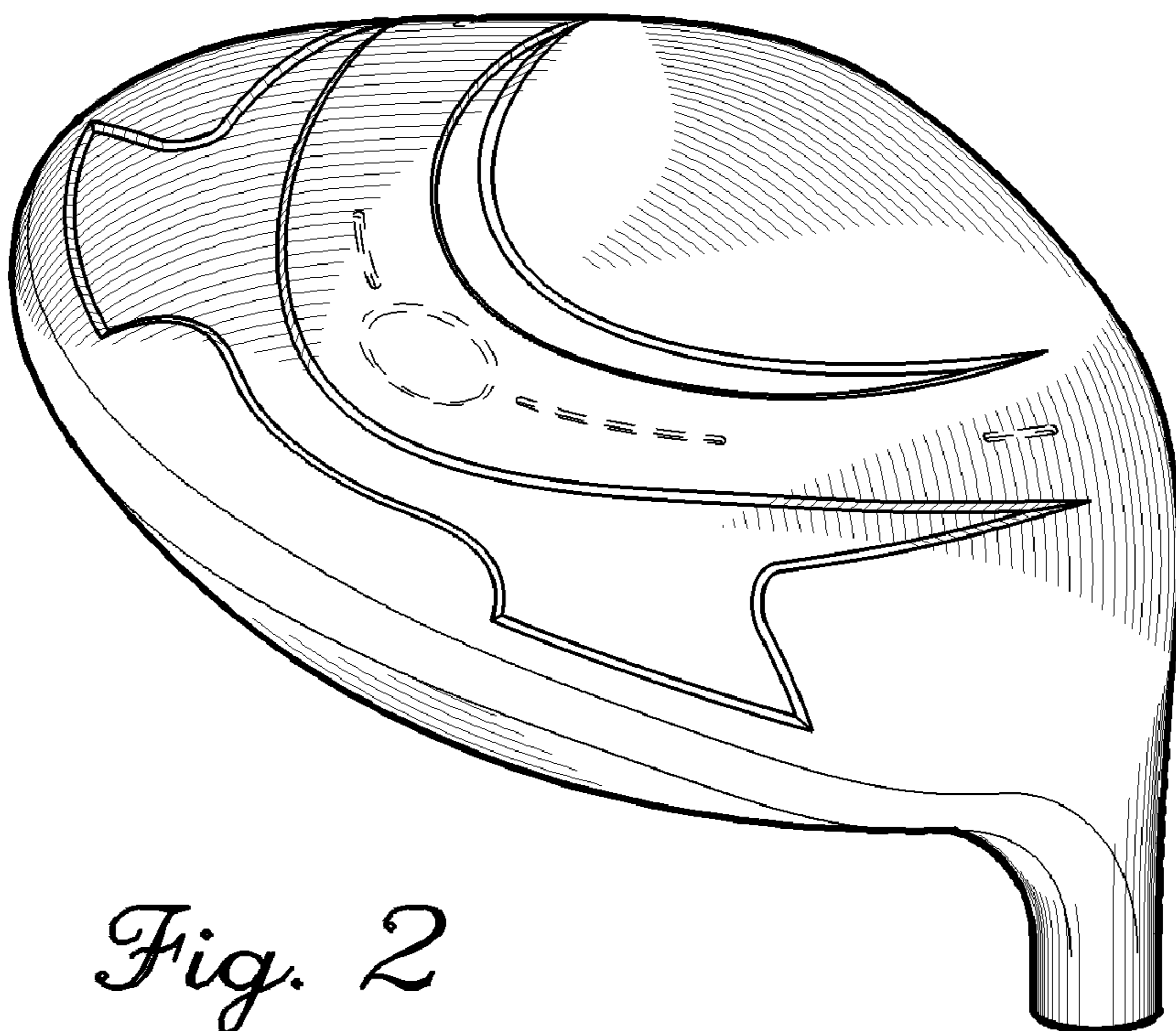

*Fig. 2*

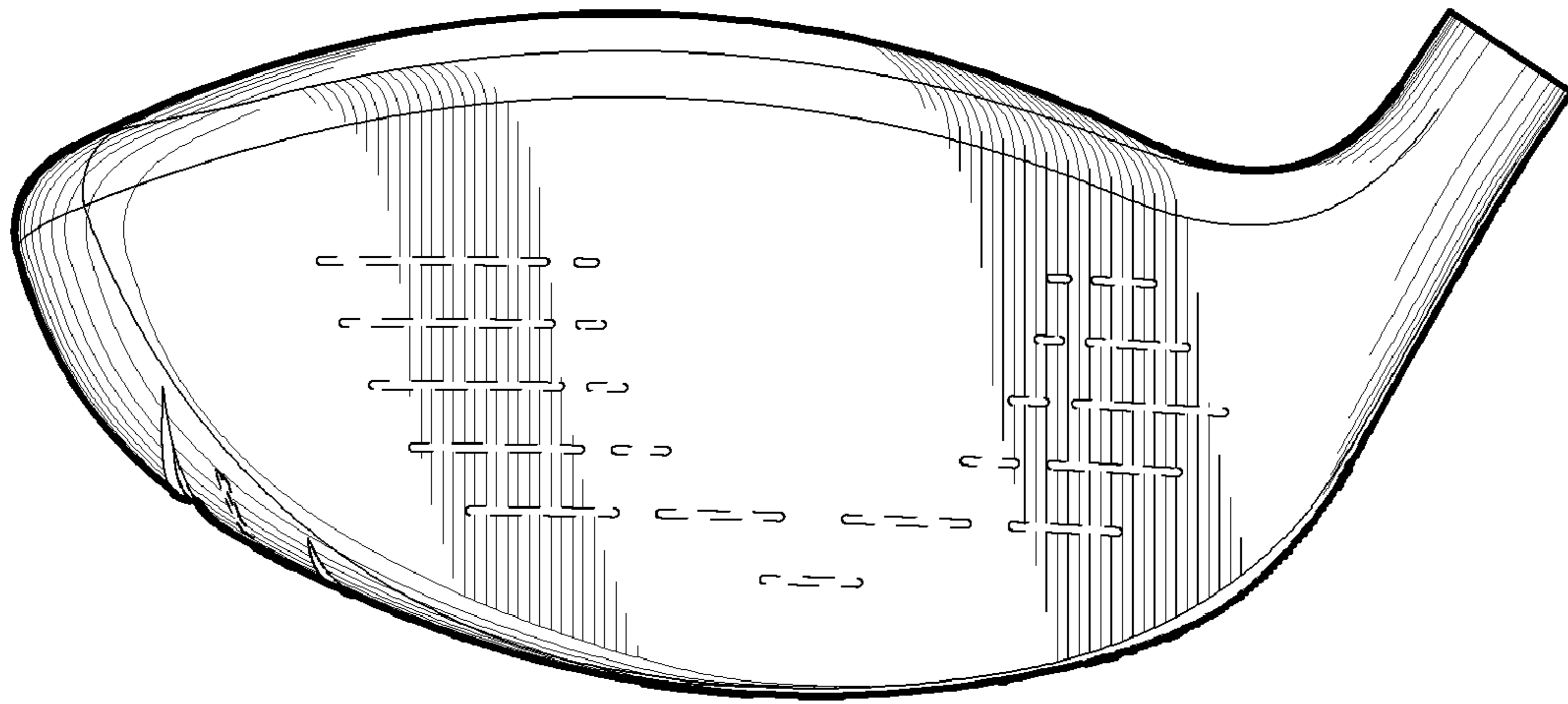

*Fig. 3*

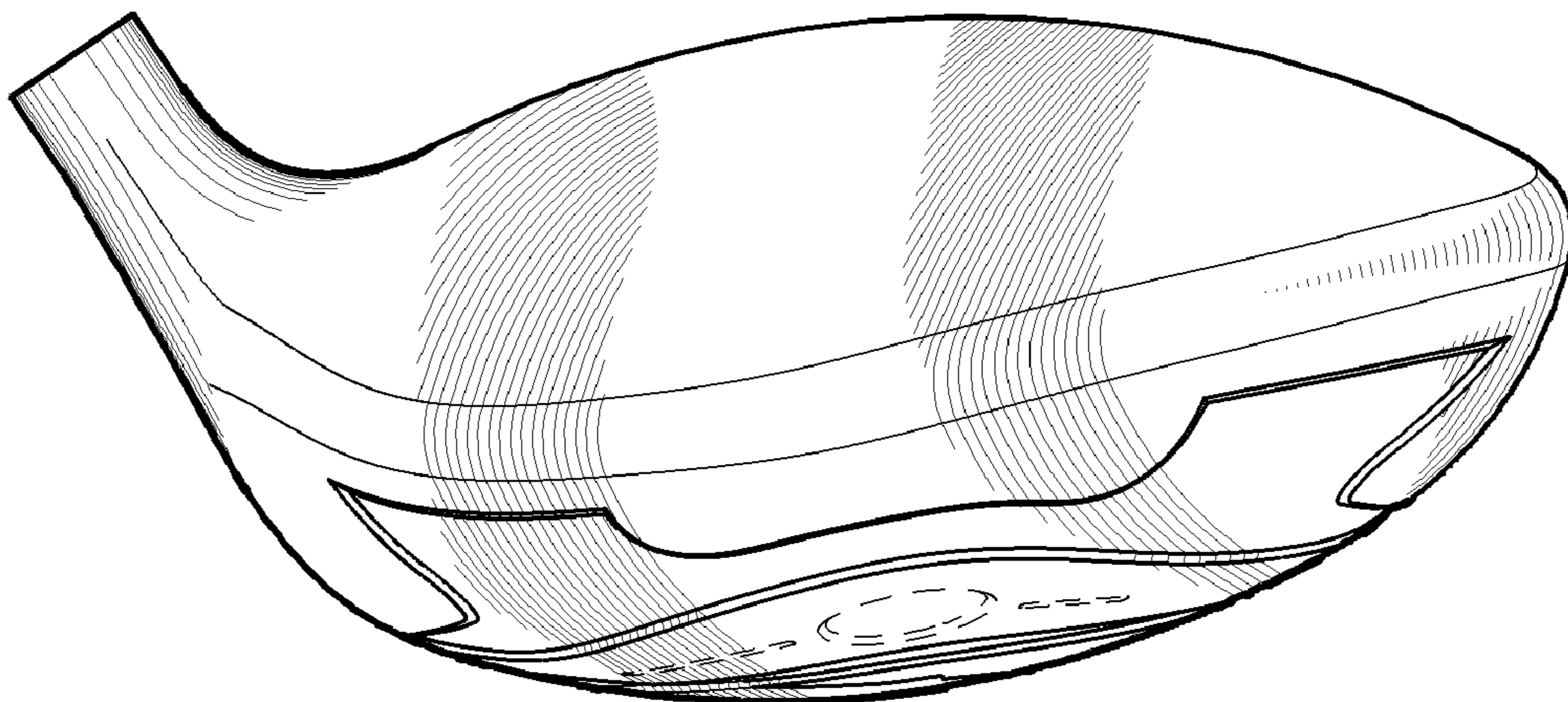

*Fig. 4*

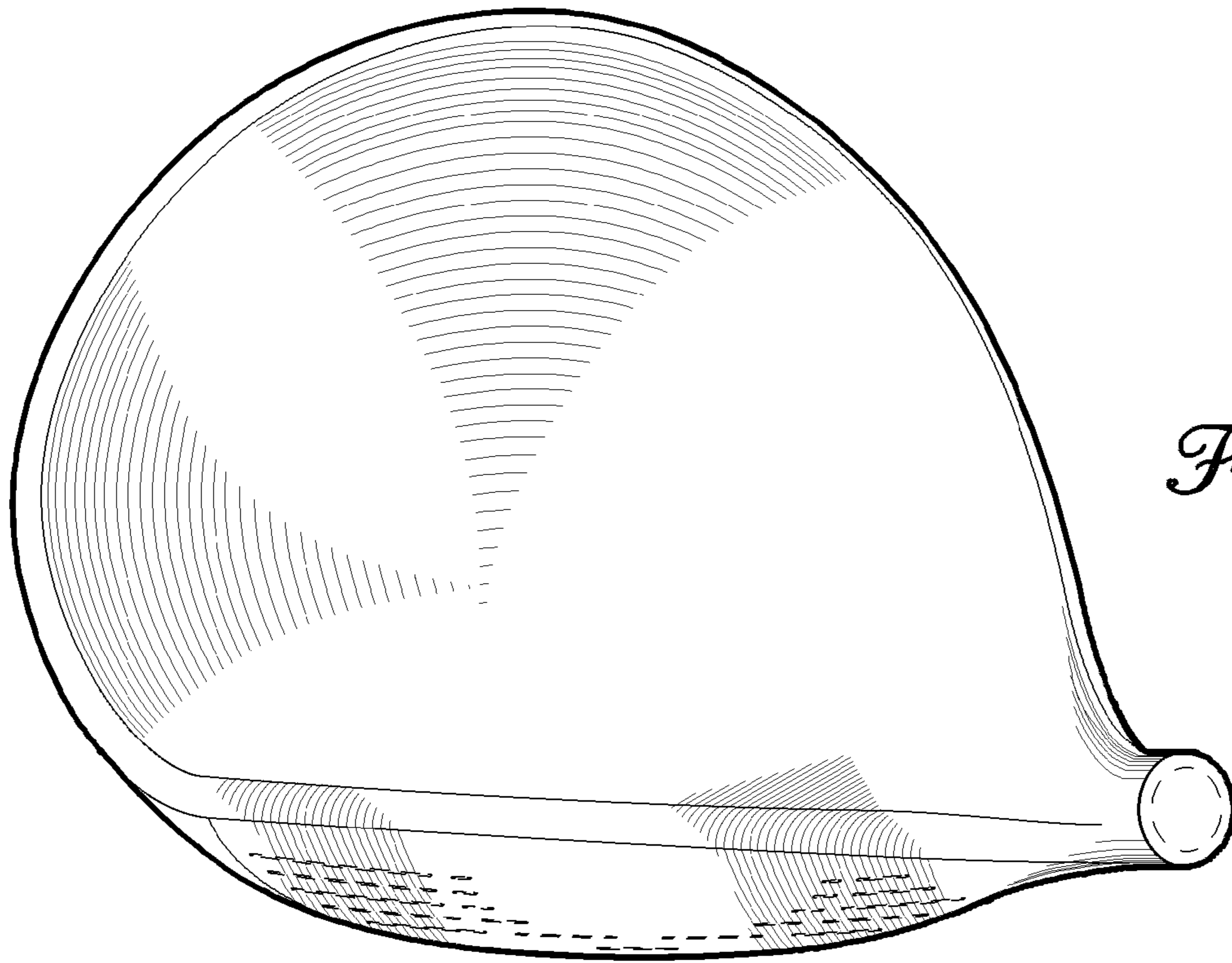

*Fig. 5*

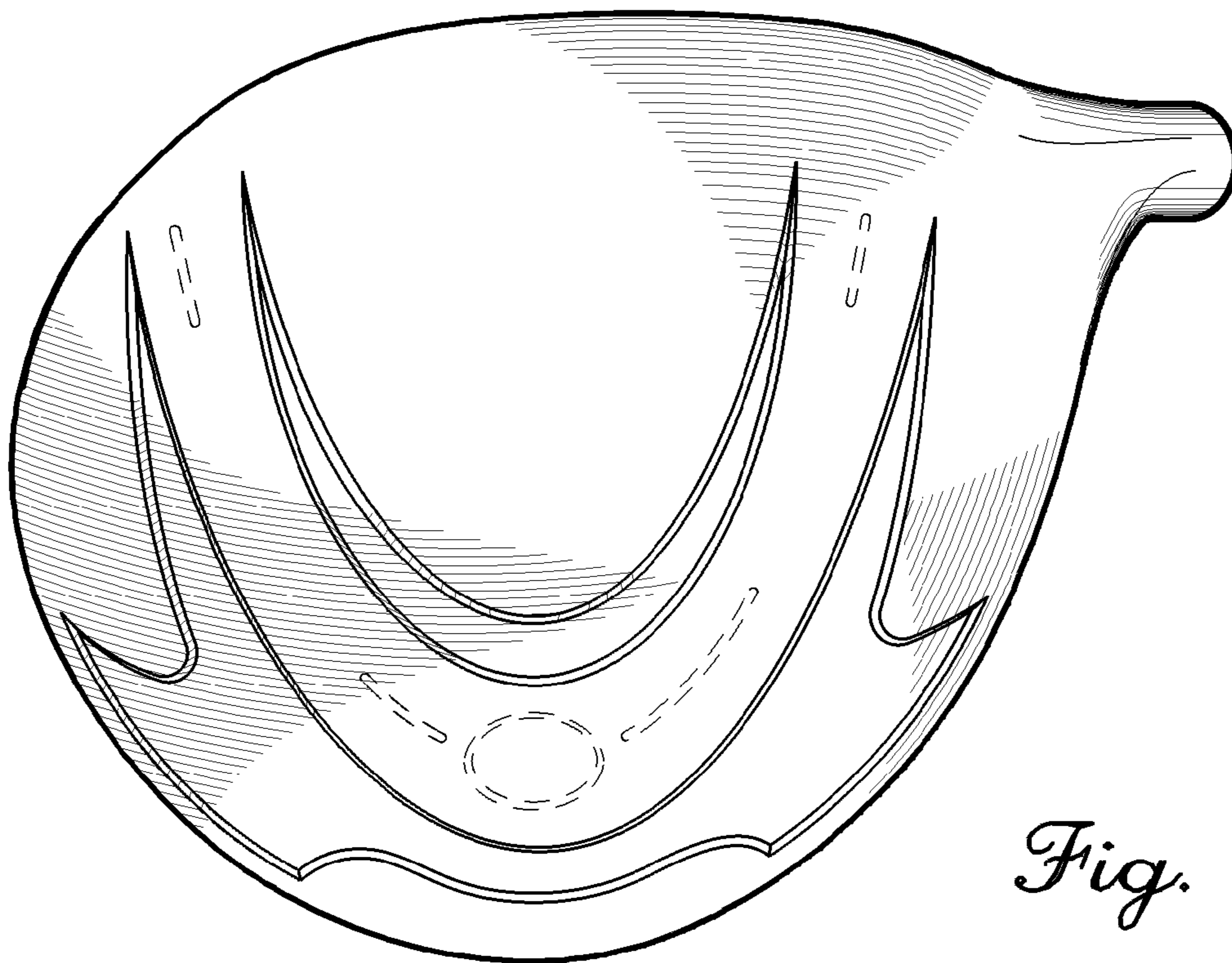

*Fig. 6*

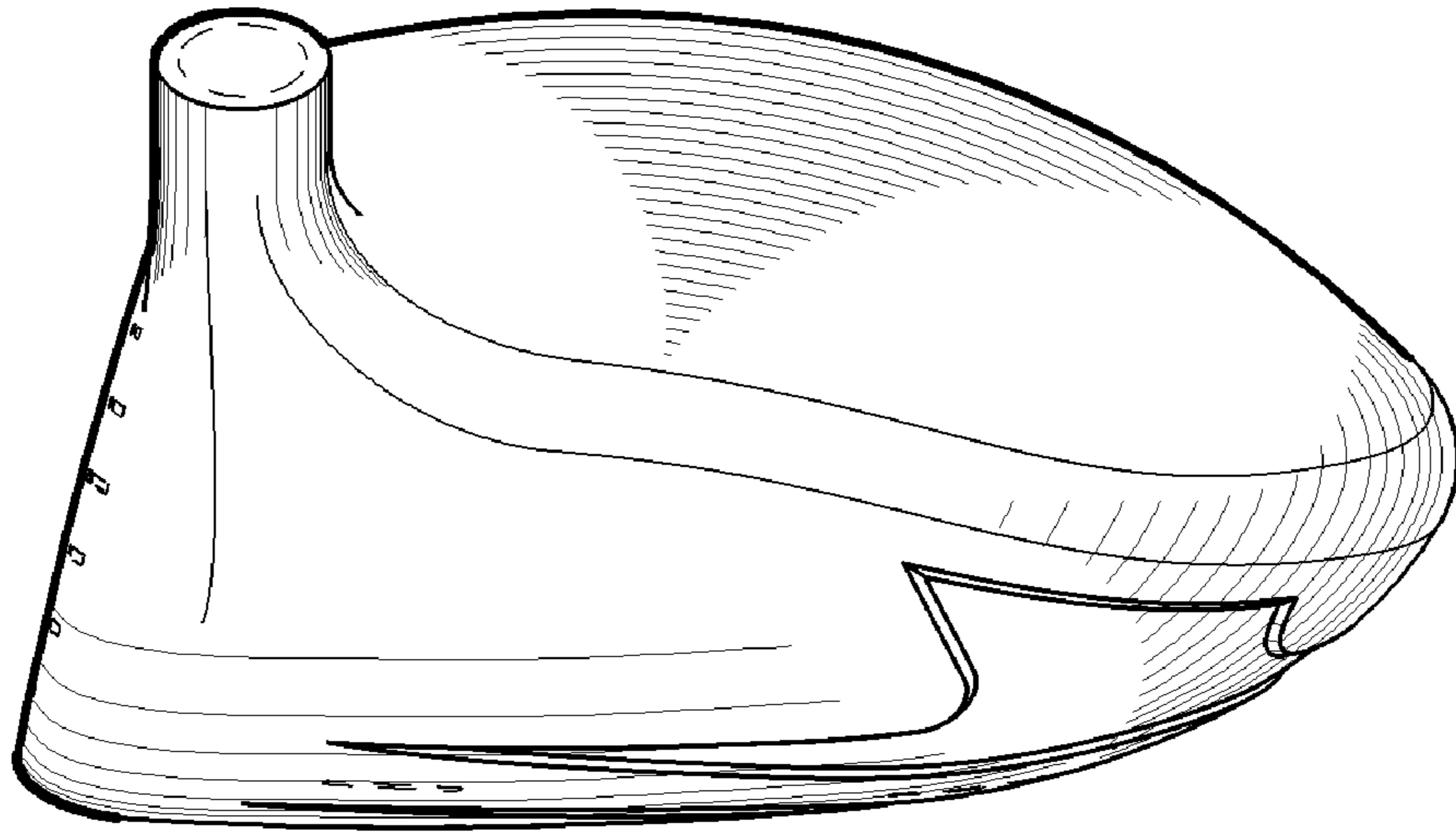

*Fig. 7*

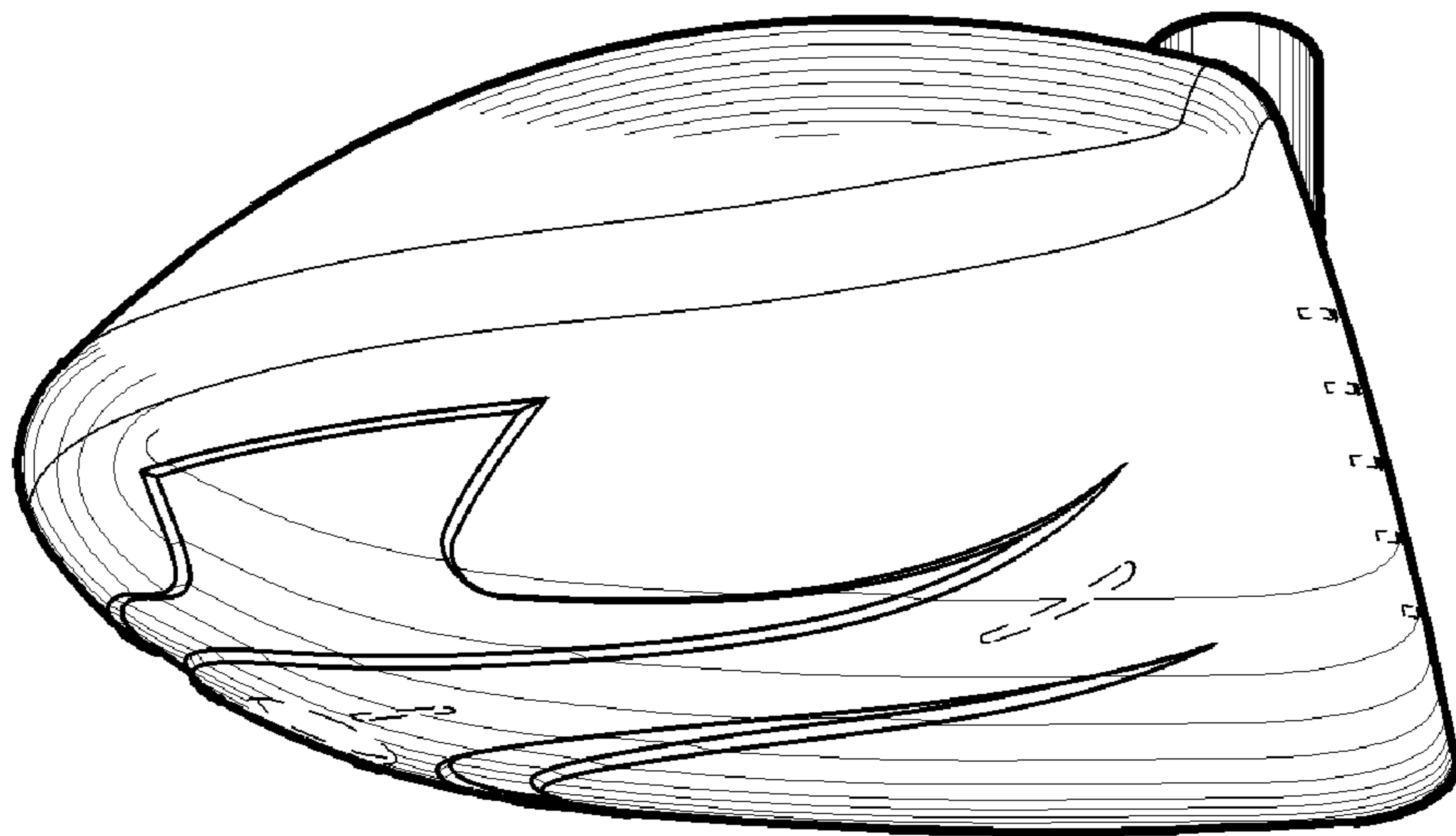

*Fig. 8*