

US00D569836S

(12) **United States Design Patent**
Han et al.

(10) **Patent No.:** **US D569,836 S**
(45) **Date of Patent:** **** May 27, 2008**

(54) **PORTABLE TELEPHONE**

(75) Inventors: **Woo-Seung Han**, Seoul (KR); **Nam-Mi Kim**, Seoul (KR); **Chang-Hwan Hwang**, Seoul (KR)

(73) Assignee: **Samsung Electronics Co., Ltd.**, Suwon, Kyunggi-Do (KR)

(**) Term: **14 Years**

(21) Appl. No.: **29/288,722**

(22) Filed: **Jun. 21, 2007**

(51) **LOC (8) Cl.** **14-03**

(52) **U.S. Cl.** **D14/138**

(58) **Field of Classification Search** D14/138,
D14/496, 137, 147, 191, 218, 247–248, 341–347;
D13/168; D18/7; 455/575.4, 90.3, 556.1,
455/556.2, 575.1, 575.3; 379/433.01–433.13;
361/814; 348/14.02

See application file for complete search history.

(56) **References Cited**

U.S. PATENT DOCUMENTS

D479,215 S *	9/2003	Yokoyama	D14/138
D503,164 S	3/2005	Park et al.		
D503,699 S	4/2005	Lee et al.		
D512,702 S	12/2005	Lee et al.		
D517,038 S	3/2006	Lee et al.		
D524,783 S *	7/2006	Lee	D14/138
D525,225 S *	7/2006	Lee	D14/138
D529,472 S	10/2006	Kim et al.		
D529,891 S	10/2006	Hyun et al.		
D531,608 S	11/2006	Kim et al.		
D531,611 S	11/2006	Kim et al.		
D531,612 S	11/2006	Kim et al.		
D531,973 S	11/2006	Kim et al.		
D533,530 S	12/2006	Kim et al.		
D533,532 S	12/2006	Kim et al.		
D534,144 S	12/2006	Chung et al.		
D534,518 S *	1/2007	Choi et al.	D14/138
D534,892 S	1/2007	Lee et al.		
D535,959 S	1/2007	Cho et al.		

D540,204 S *	4/2007	Aguilar	D10/65
7,210,629 B2 *	5/2007	Cho et al.	235/454
D545,292 S	6/2007	Lee et al.		
D547,294 S *	7/2007	Cho et al.	D14/138
D547,330 S *	7/2007	Lee et al.	D14/496
D549,206 S *	8/2007	Lee et al.	D14/138
D550,189 S *	9/2007	Kim et al.	D14/138
D552,578 S *	10/2007	Han et al.	D14/138
D553,114 S *	10/2007	Baik et al.	D14/138
D553,600 S *	10/2007	Kim et al.	D14/138
D554,092 S *	10/2007	Choi et al.	D14/138
D554,097 S *	10/2007	Lee	D14/138
D555,620 S *	11/2007	Lee et al.	D14/138
D555,623 S *	11/2007	Cho et al.	D14/138
D556,724 S *	12/2007	Choi et al.	D14/138

(Continued)

OTHER PUBLICATIONS

Gigabyte g-Smart, announced 2005, [online], [retrieved on Feb. 20, 2007]. Retrieved from Internet ,<URL: <http://www.gsmarena.com>>.*

(Continued)

Primary Examiner—Jeffrey D. Asch
Assistant Examiner—Bridget L Eland

(74) *Attorney, Agent, or Firm*—Flynn, Thiel, Boutell & Tanis, P.C.

(57) **CLAIM**

The ornamental design for a portable telephone, as shown and described.

DESCRIPTION

FIG. 1 is a right side front perspective view of a portable telephone showing our new design;
FIG. 2 is a front elevational view thereof;
FIG. 3 is a rear elevational view thereof;
FIG. 4 is a left side elevational view thereof;
FIG. 5 is a right side elevational view thereof;
FIG. 6 is a top plan view thereof; and,
FIG. 7 is a bottom plan view thereof.

1 Claim, 4 Drawing Sheets

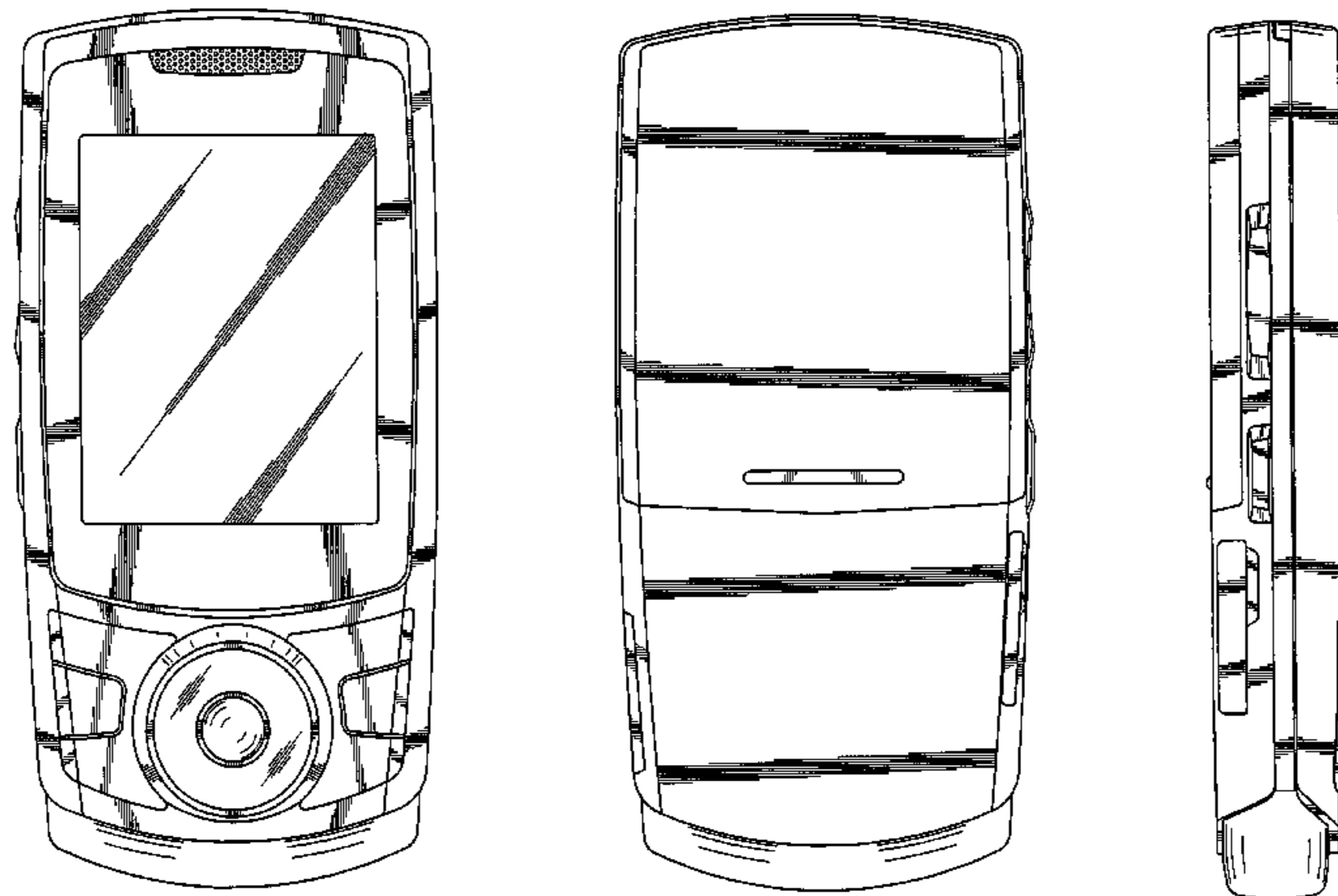

U.S. PATENT DOCUMENTS

D557,237	S	*	12/2007	Jung et al.	D14/138
D557,242	S	*	12/2007	Kim et al.	D14/138
D557,245	S	*	12/2007	Kim et al.	D14/138
D560,199	S	*	1/2008	Lee et al.	D14/138
2003/0064688	A1	*	4/2003	Mizuta et al.	455/90
2005/0107126	A1	*	5/2005	Kim	455/565
2005/0124394	A1	*	6/2005	Kim et al.	455/575.3
2007/0021160	A1	*	1/2007	Li	455/575.4

OTHER PUBLICATIONS

Samsung i520, announced Feb. 2007, [online], [retrieved on Feb. 16, 2007]. Retrieved from Internet ,<URL: <http://www.gsmarena.com>>.*

Samsung i400, announced Apr. 2007, [online], [retrieved on May 18, 2007]. Retrieved from Internet ,<URL: <http://www.gsmarena.com>>.*

Samsung i560, announced Oct. 2007, [online], [retrieved on Dec. 13, 2007]. Retrieved from Internet ,<URL: <http://www.gsmarena.com>>.*

U.S. Appl. No. 29/273,486, Applicant: Chang-Hoon Suk, et al. filed Mar. 6, 2007 entitled Portable Telephone.

U.S. Appl. No. 29/273,487, Applicant: Chang-Hoon Suk, et al. filed Mar. 6, 2007 entitled Portable Telephone.

U.S. Appl. No. 29/273,485, Applicant: Jong-Yun Jeoung, et al. filed Mar. 6, 2007 entitled Portable Telephone.

U.S. Appl. No. 29/288,721, Applicant: Woo-Seung Han, et al. filed Jun. 21, 2007 entitled Portable Telephone.

U.S. Appl. No. 29/288,718, Applicant: Woo-Seung Han, et al. filed Jun. 21, 2007 entitled Portable Telephone.

Samsung D520 telephone, announced 2006, February [online], [retrieved on Jul. 24, 2007]. Retrieved from Internet, URL:<http://www.gsmarena.com>.

Samsung D720 telephone, announced 2005, 1st quarter [online], [retrieved on Feb. 8, 2007]. Retrieved from Internet, URL:<http://www.gsmarena.com>.

Samsung E390 telephone, announced 2006, October [online], [retrieved on Jul. 25, 2007]. Retrieved from Internet, URL:<http://www.gsmarena.com>.

Samsung E800 telephone, announced 2004, March [online], [retrieved on Jul. 24, 2007]. Retrieved from Internet, URL:<http://www.gsmarena.com>.

Samsung E860 telephone, announced 2005, 4th quarter, [retrieved on Jul. 24, 2007]. Retrieved from Internet, URL:<http://www.gsmarena.com>.

Nokia 6111 telephone, announced 2005, June [online], [retrieved on Feb. 16, 2007]. Retrieved from Internet, URL:<http://www.gsmarena.com>.

Nokia 6270 telephone, announced 2005, June [online], [retrieved on Feb. 16, 2007]. Retrieved from Internet, URL:<http://www.gsmarena.com>.

Nolia 6288 telephone, announced 2006, September [online], [retrieved on Feb. 16, 2007]. Retrieved from Internet, URL:<http://www.gsmarena.com>.

* cited by examiner

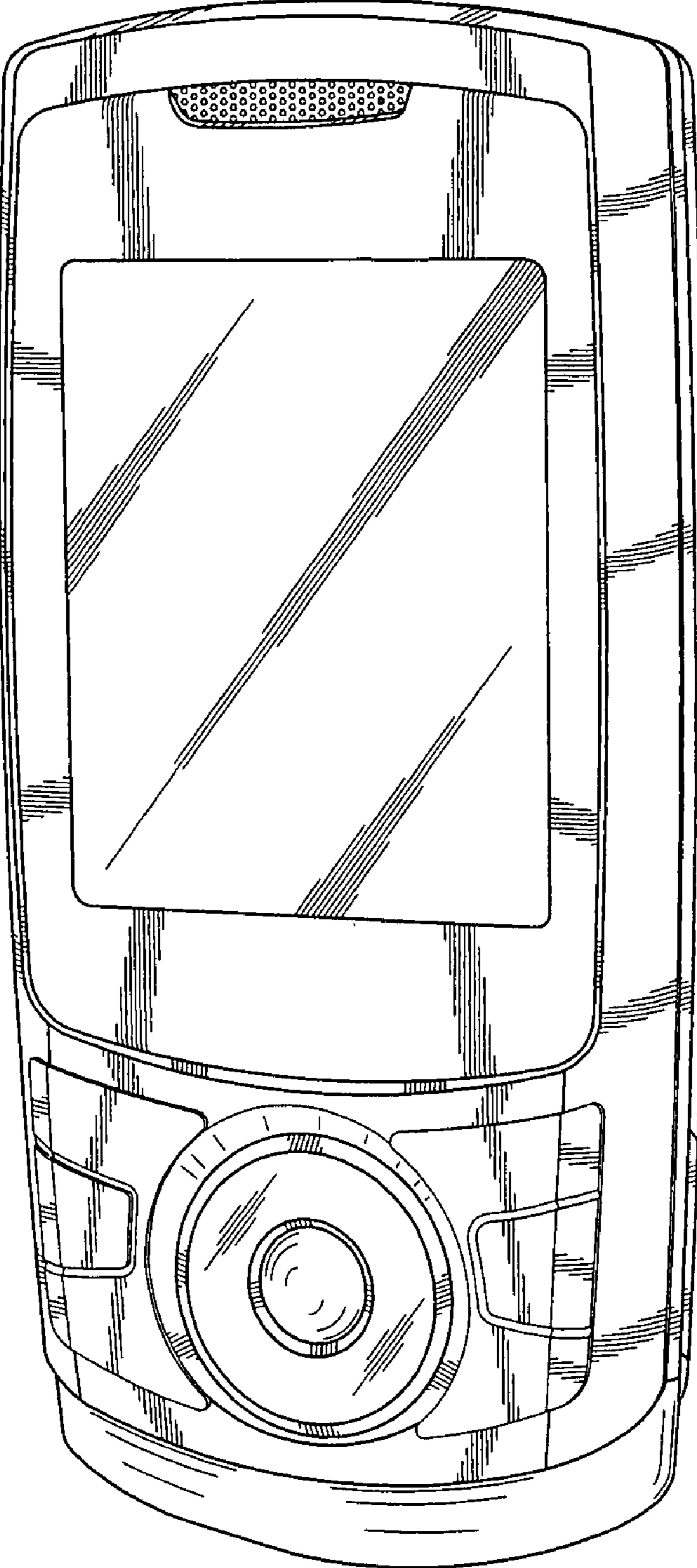

FIG. 1

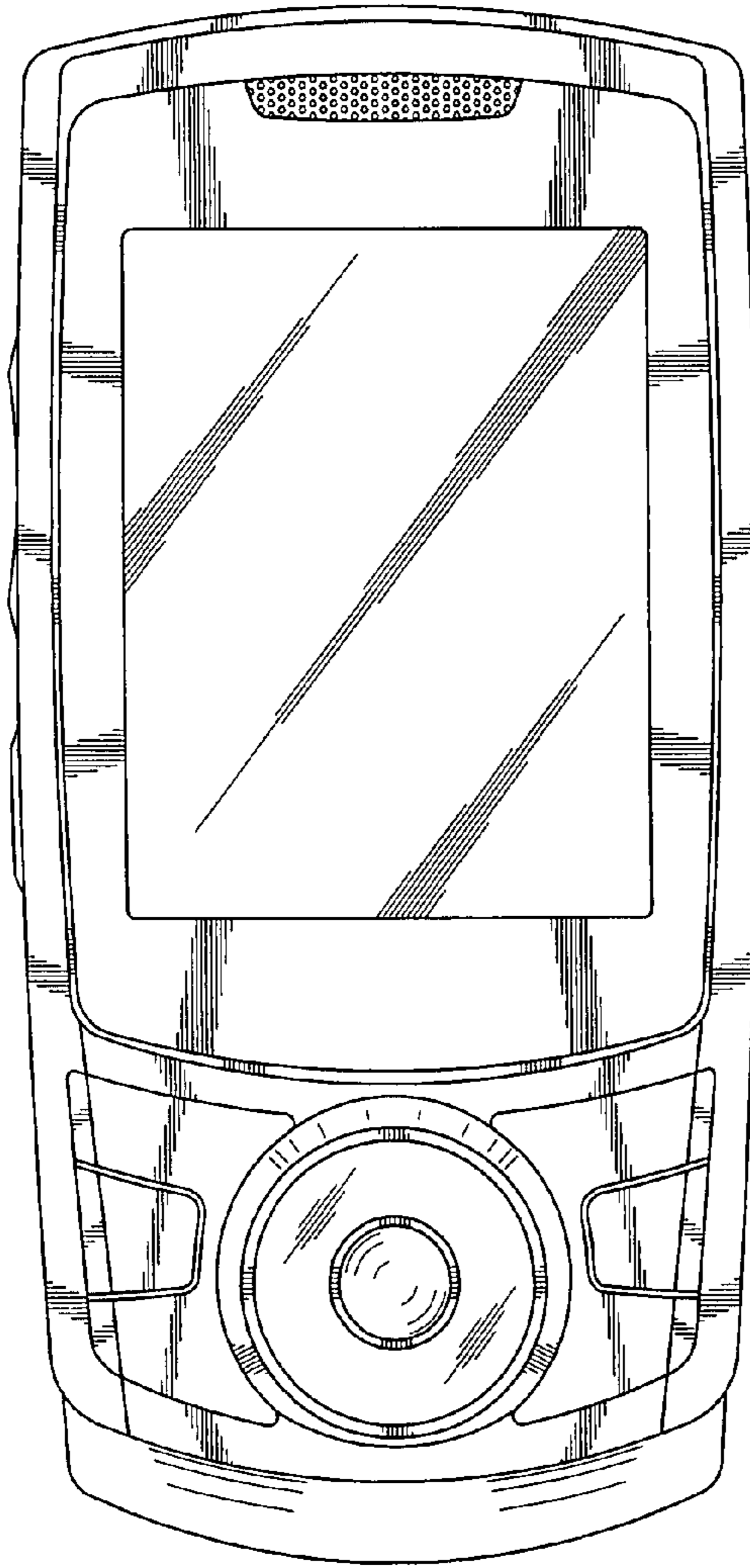

FIG. 2

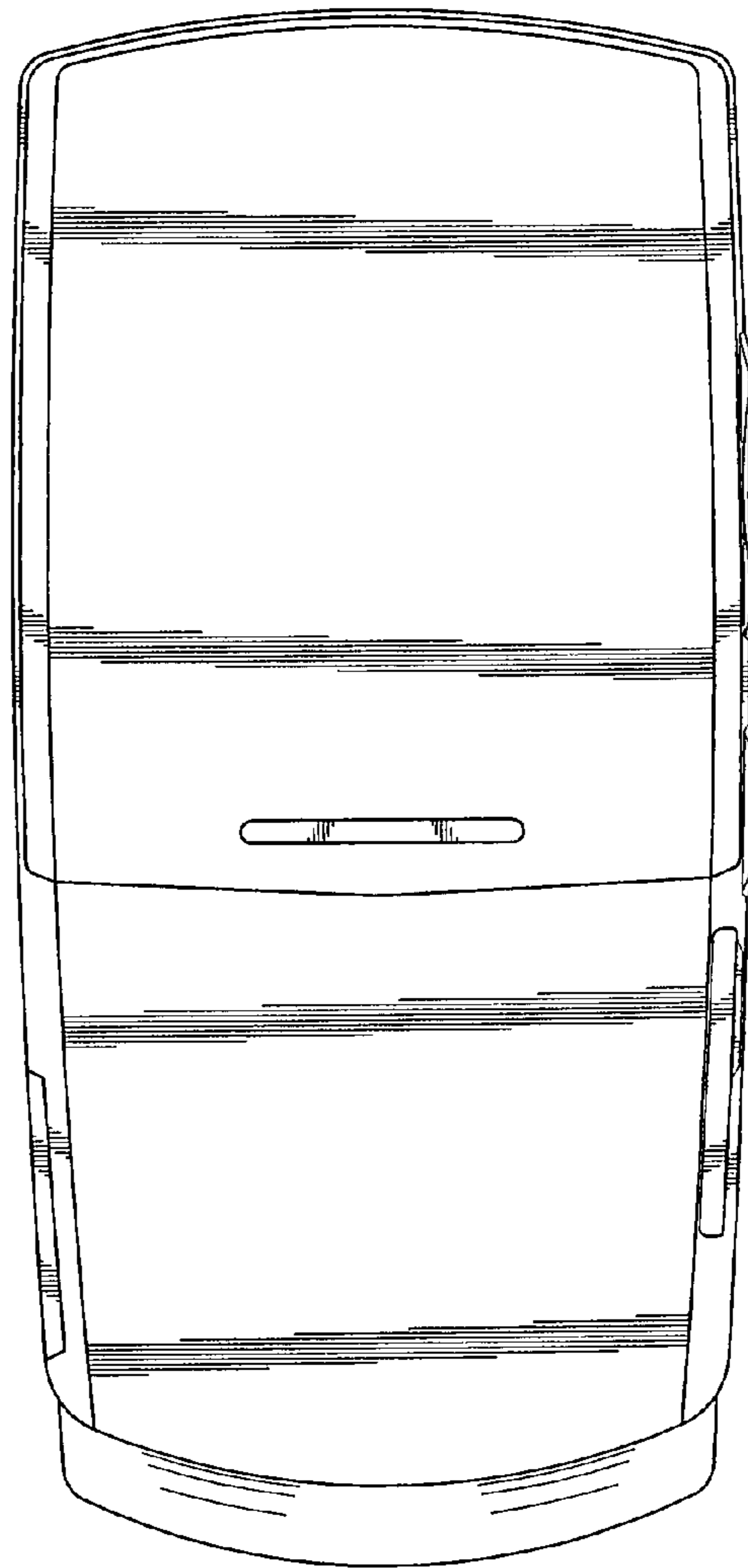

FIG. 3

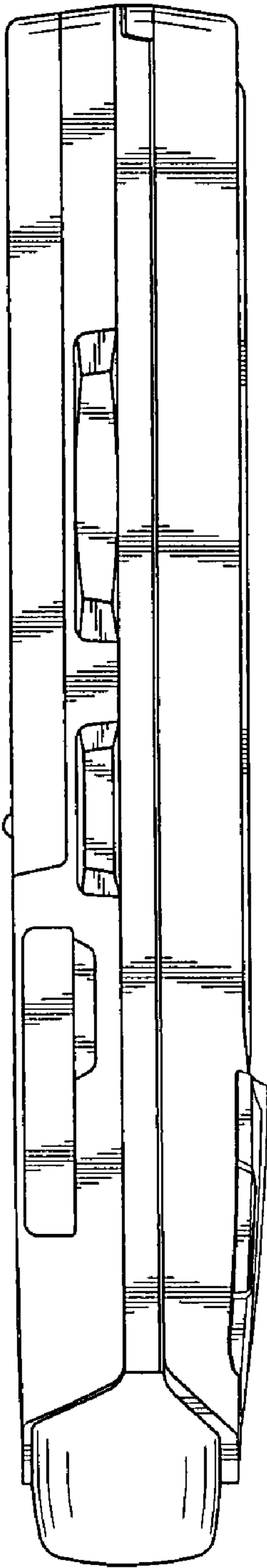

FIG. 4

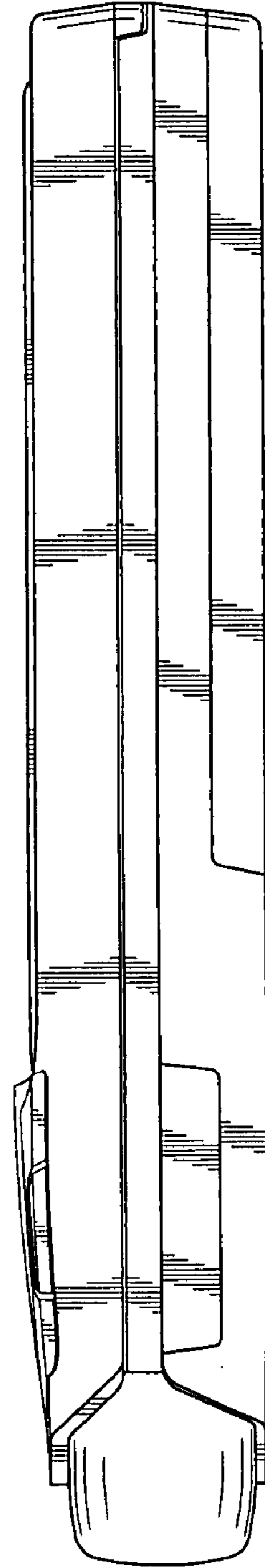

FIG. 5

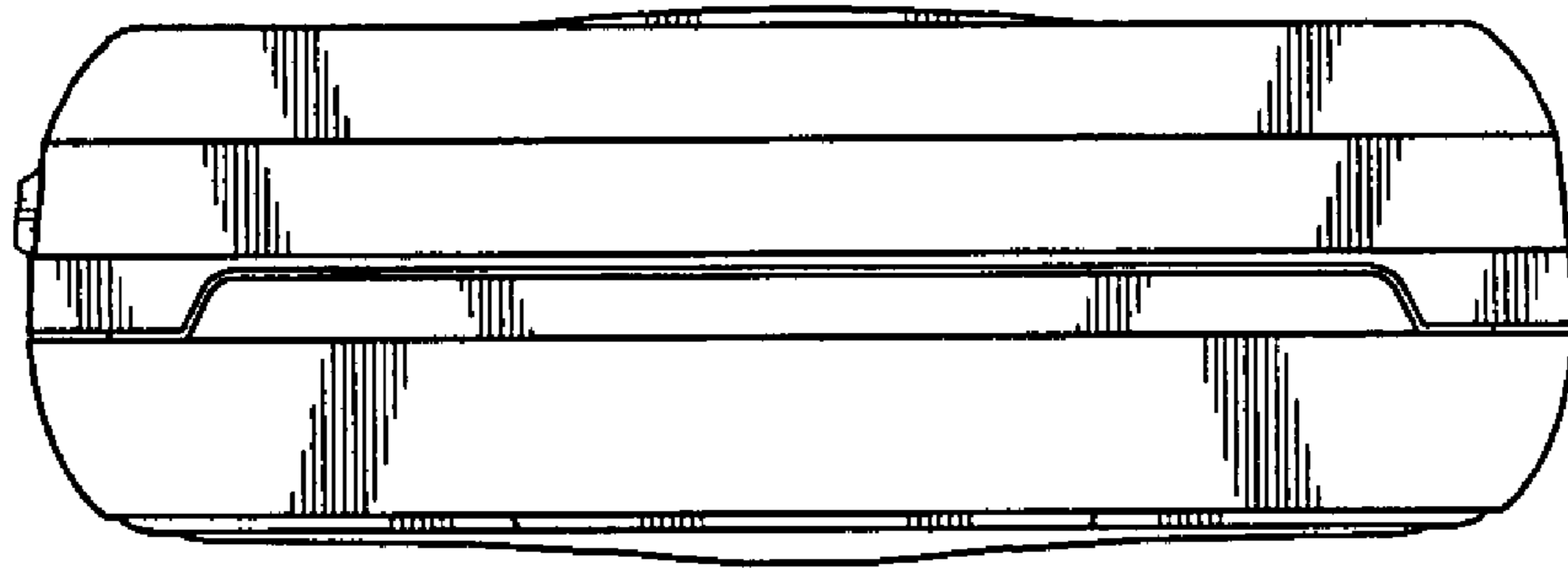

FIG. 6

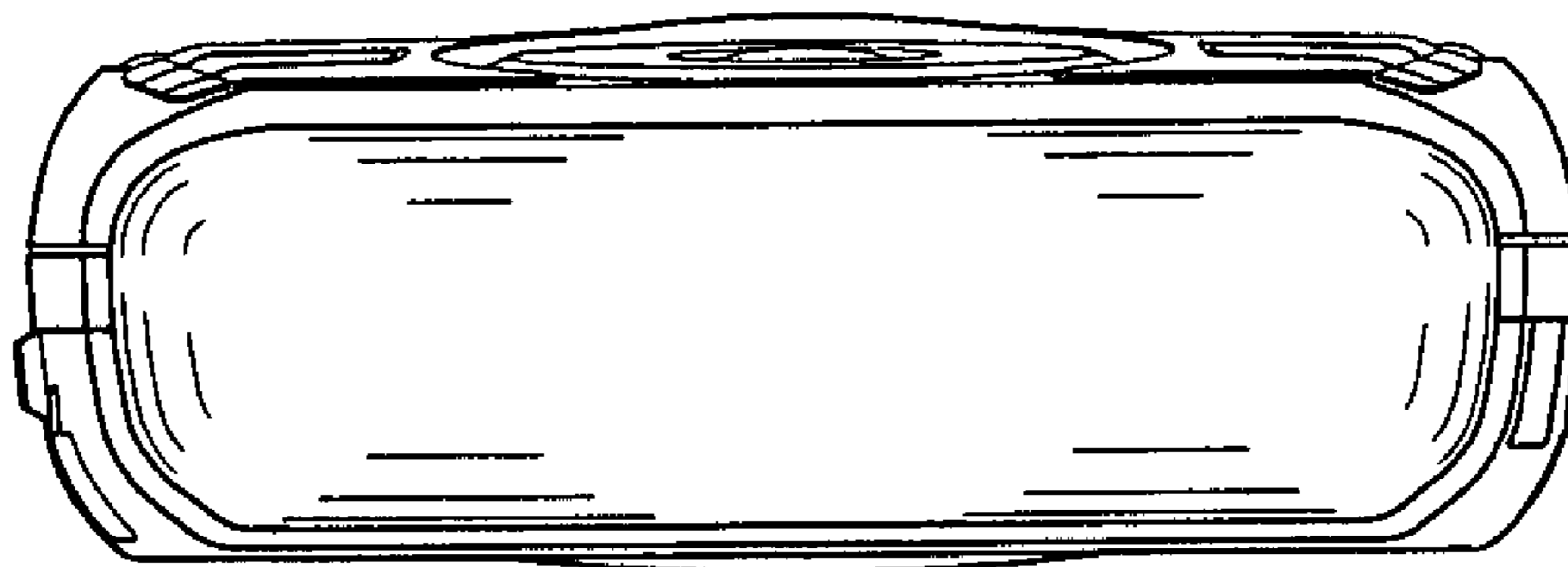

FIG. 7