

US00D569823S

(12) **United States Design Patent**
Lyles et al.

(10) **Patent No.:** **US D569,823 S**
(45) **Date of Patent:** **** May 27, 2008**

(54) **HANDSET**

2006/0111052 A1* 5/2006 Gartrell 455/90.3

(75) Inventors: **Justin Lyles**, San Diego, CA (US);
Paresh Desai, Los Angeles, CA (US)

FOREIGN PATENT DOCUMENTS

WO DM/064133 * 5/2003
WO DM/065946 * 9/2004

(73) Assignee: **Nokia Corporation**, Espoo (FI)

OTHER PUBLICATIONS

(**) Term: **14 Years**

LG B2000, announced 1Q 2005, <URL:www.gsmarena.com>, retrieved from internet Dec. 20, 2007.*
Nokia 2100, announced 1Q 2003, <URL:www.gsmarena.com>, retrieved from internet Dec. 20, 2007.*

(21) Appl. No.: **29/246,311**

* cited by examiner

(22) Filed: **Mar. 30, 2006**

(51) **LOC (8) Cl.** **14-03**

Primary Examiner—Ian Simmons
Assistant Examiner—Carla Wright

(52) **U.S. Cl.** **D14/138**

(74) *Attorney, Agent, or Firm*—Banner & Witcoff, Ltd.

(58) **Field of Classification Search** D14/137–138,
D14/147–148, 156, 218, 247–248, 341–347,
D14/496, 390, 399, 455, 456; D16/208;
D21/329, 331, 333, 517; 348/14.01–14.02;
361/814; 379/433.01–433.13; 455/90.3,
455/556.1–556.2, 566, 575.1, 575.3, 575.4;
D13/164, 168; 439/165; 343/702

See application file for complete search history.

(57) **CLAIM**

The ornamental design for a handset, as shown and described.

(56) **References Cited**

DESCRIPTION

U.S. PATENT DOCUMENTS

D459,332 S	*	6/2002	Peiker	D14/147
D484,475 S	*	12/2003	Sheu	D14/138
D488,789 S	*	4/2004	Lee	D14/138
D500,992 S	*	1/2005	Shen et al.	D14/138
D511,334 S	*	11/2005	Winebrenner et al.	D14/138
D515,059 S	*	2/2006	Wu	D14/138
D515,528 S	*	2/2006	Miyazawa et al.	D14/138
D524,274 S	*	7/2006	Choi et al.	D14/138
D524,275 S	*	7/2006	Shin	D14/138
D538,250 S	*	3/2007	Choi et al.	D14/138
D539,256 S	*	3/2007	Kim et al.	D14/138
D545,793 S	*	7/2007	Kim et al.	D14/138

FIG. 1 is a bottom plan view of a handset showing our new design;

FIG. 2 is a right side view thereof;

FIG. 3 is a front view thereof;

FIG. 4 is a left side view thereof;

FIG. 5 is a top plan view thereof;

FIG. 6 is a rear view thereof;

FIG. 7 is a perspective front view thereof; and,

FIG. 8 is a perspective rear view thereof.

The broken line showing of environmental structures is for illustrative purposes only and forms no part of the claimed design.

1 Claim, 3 Drawing Sheets

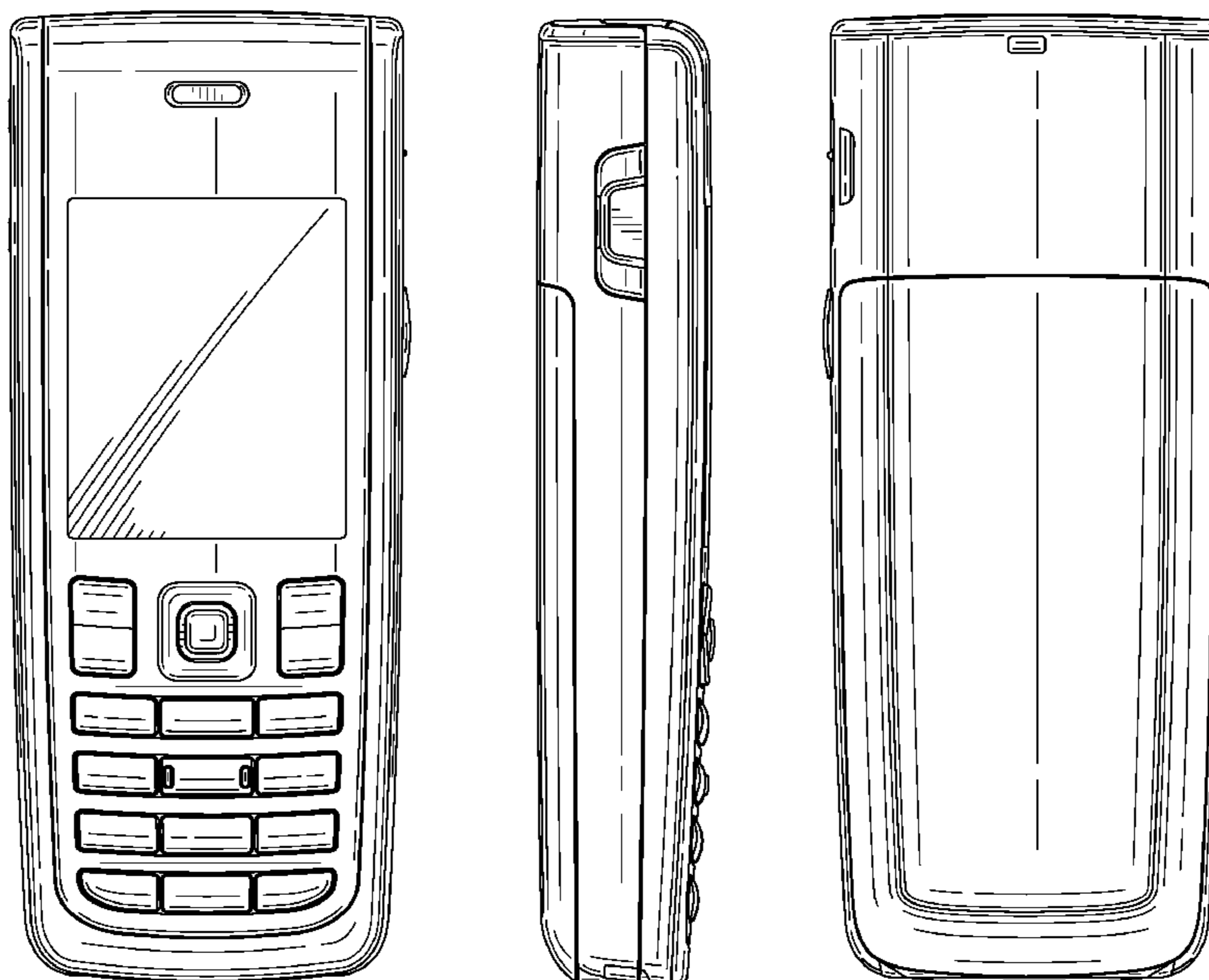

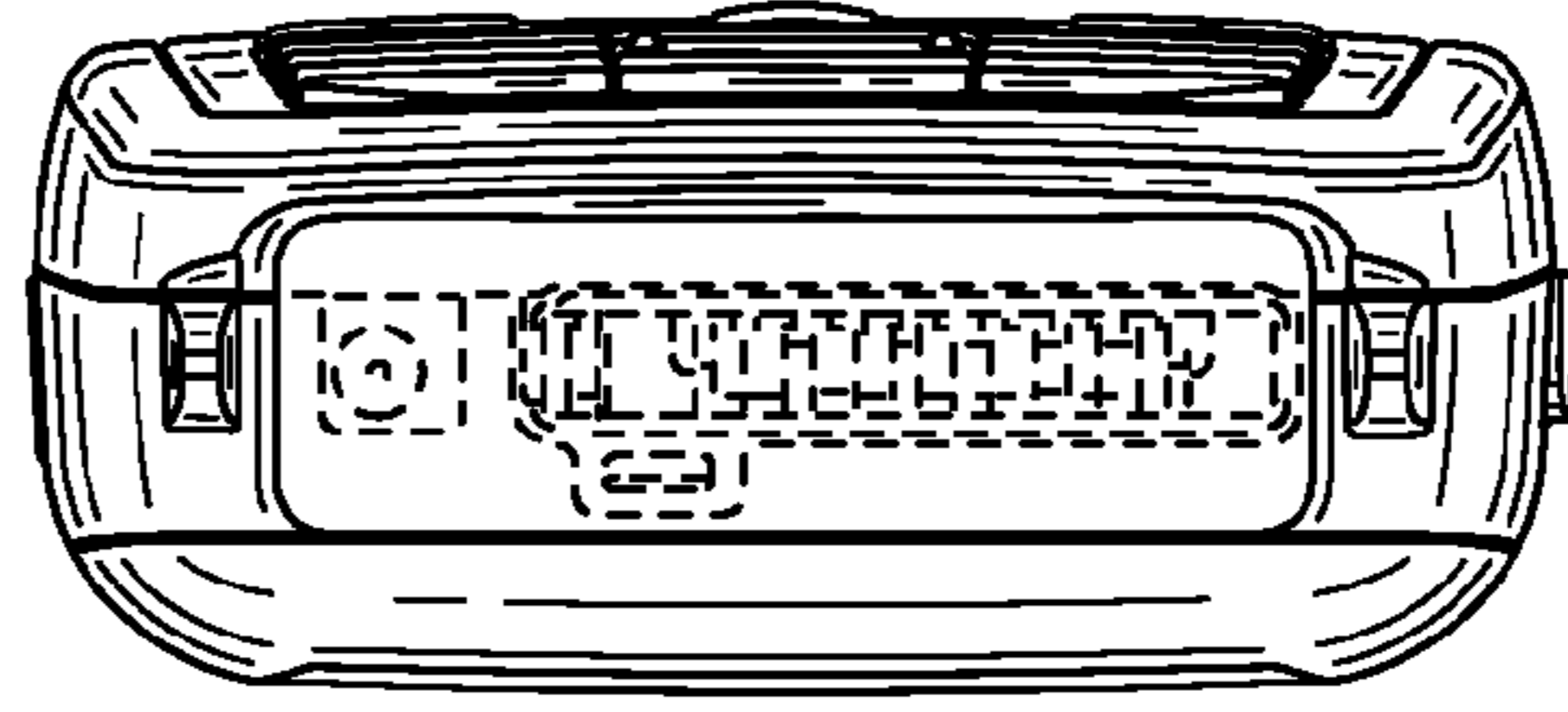

FIG. 1



FIG. 2

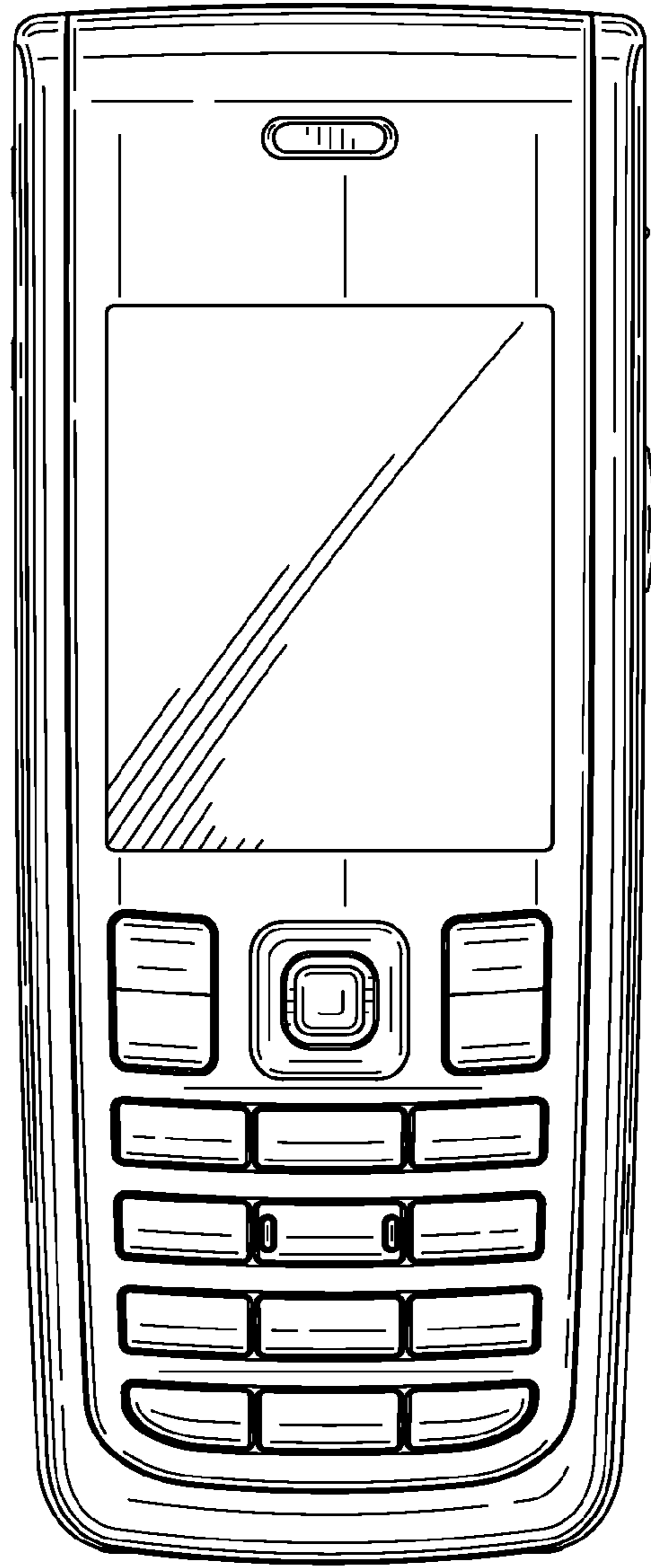

FIG. 3

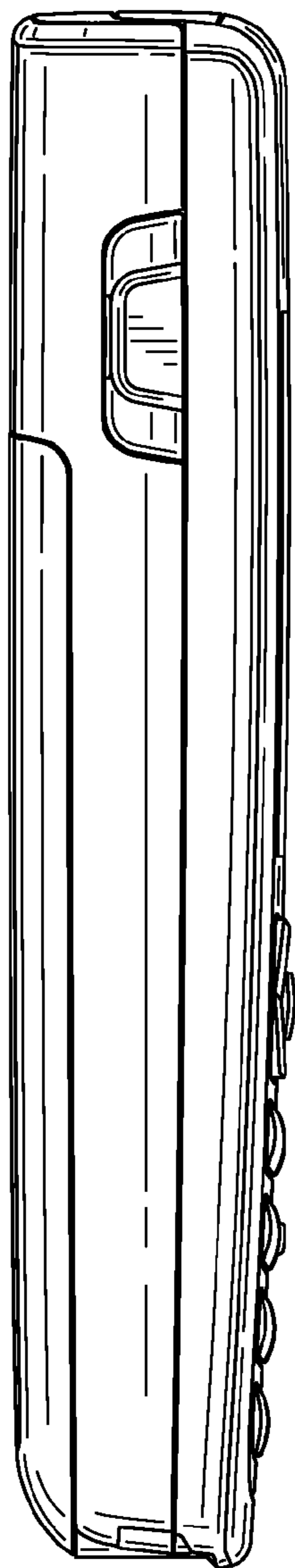

FIG. 4

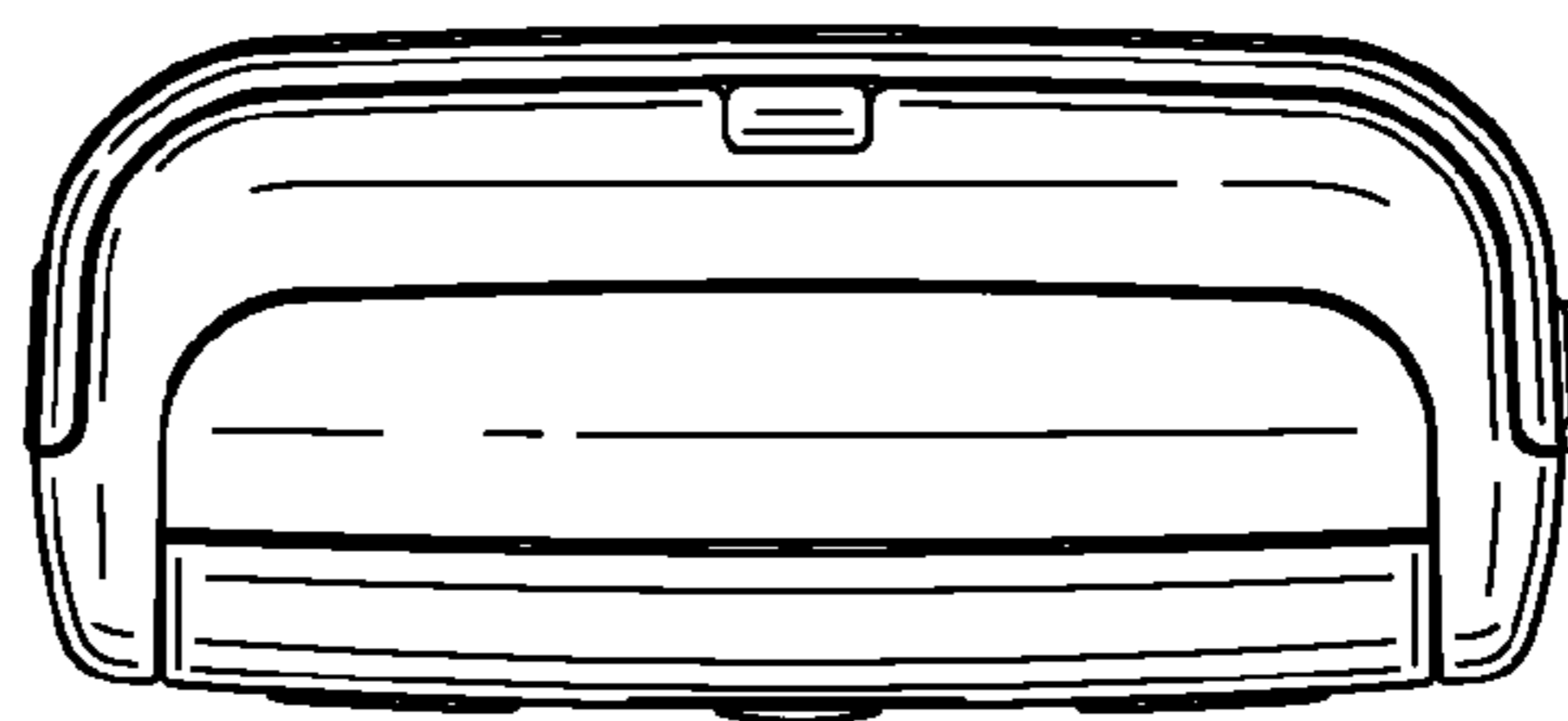

FIG. 5

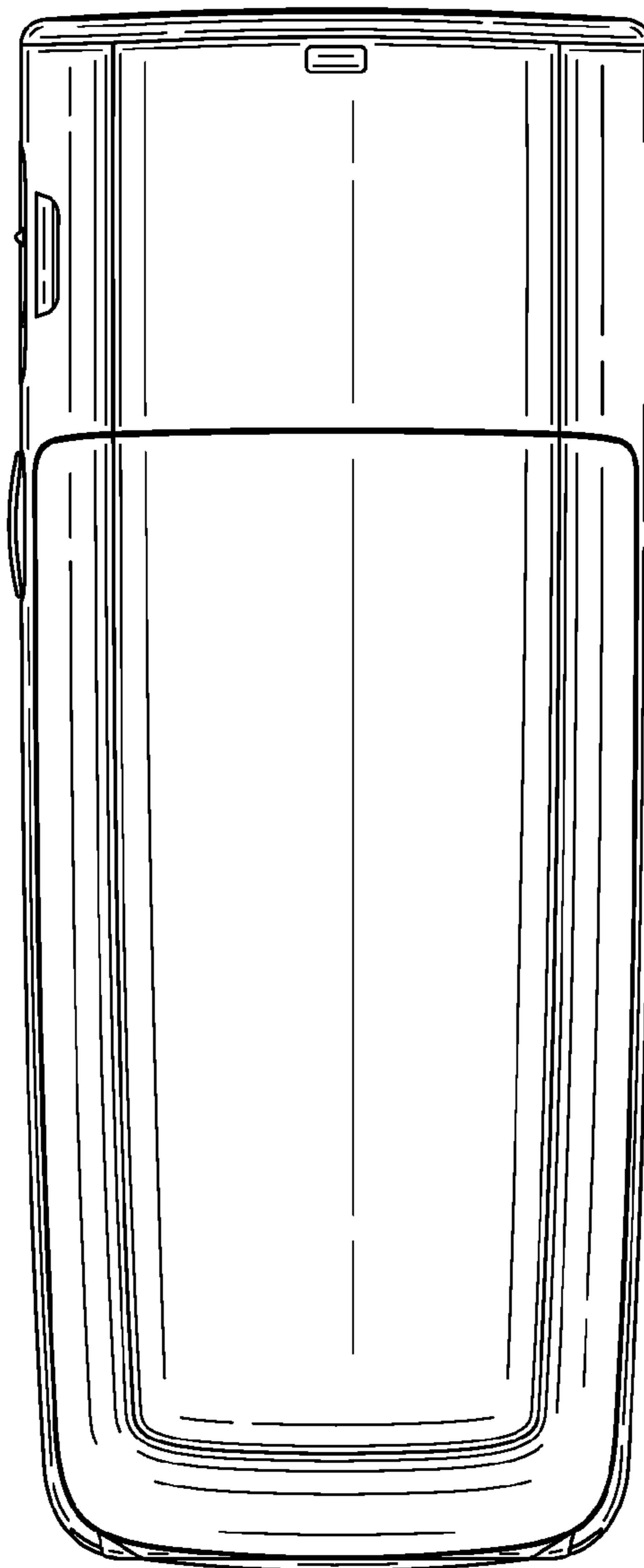

FIG. 6

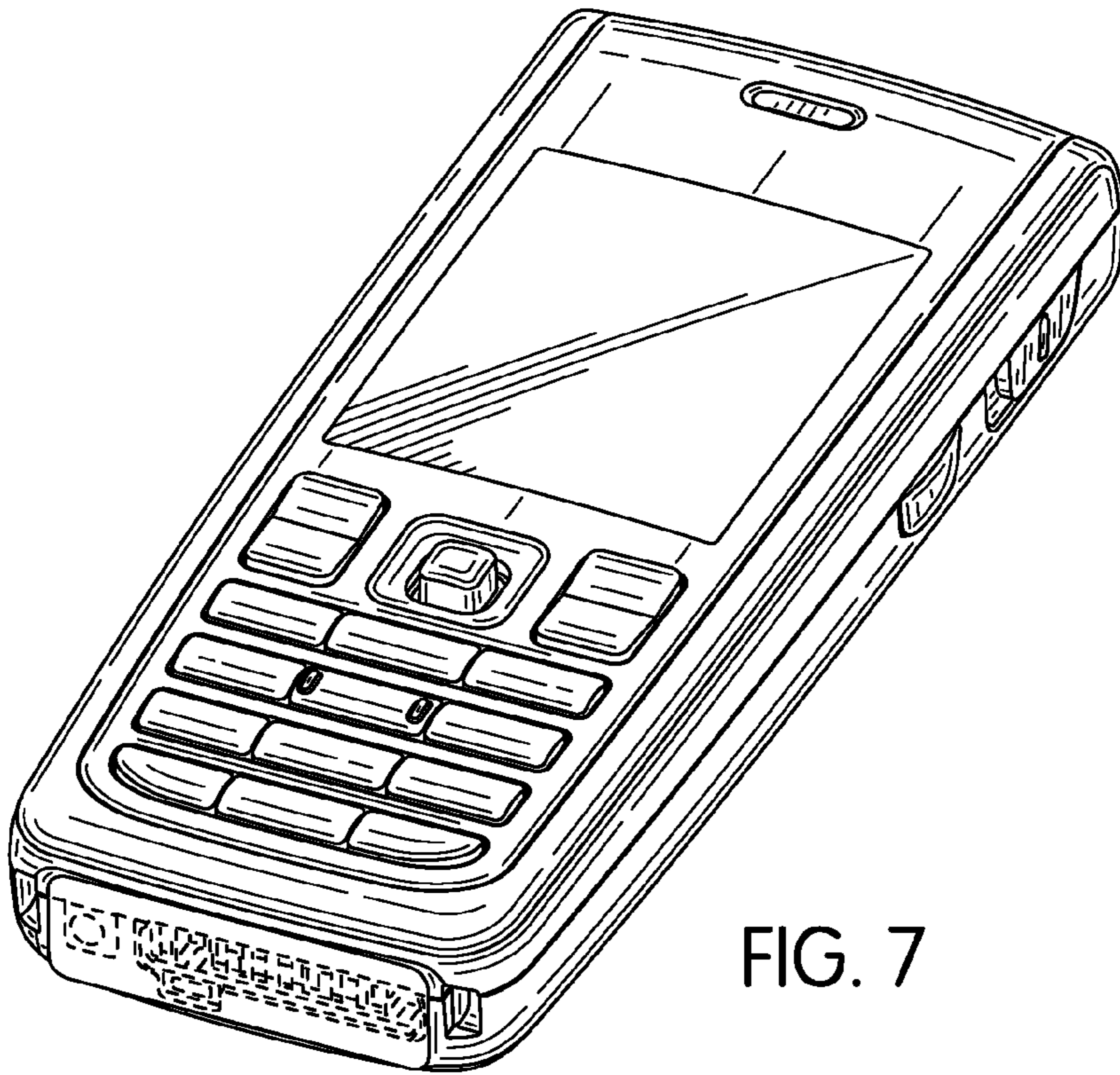

FIG. 7

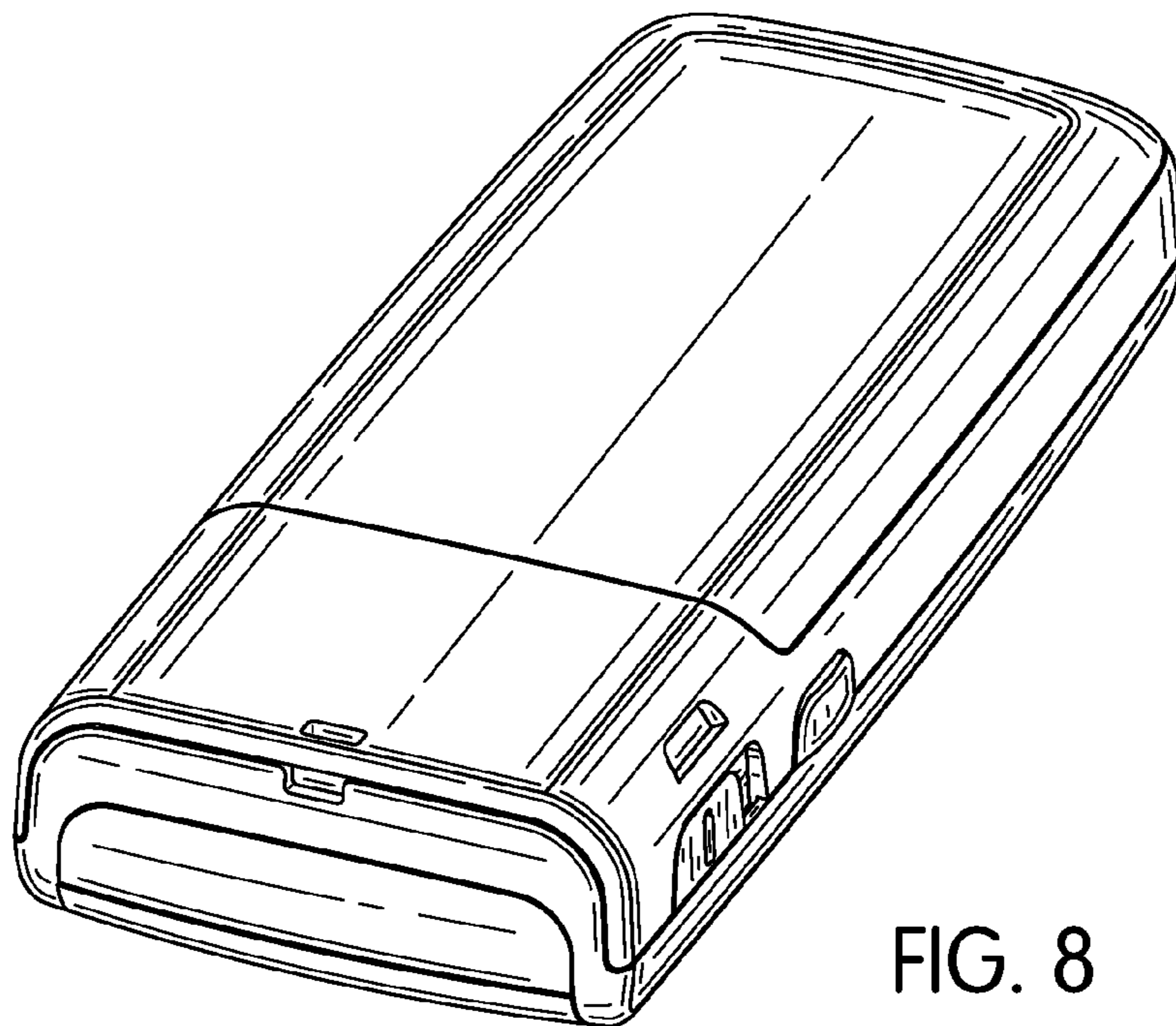

FIG. 8