



US00D569781S

(12) **United States Design Patent**
Hattori et al.

(10) **Patent No.:** **US D569,781 S**

(45) **Date of Patent:** **** May 27, 2008**

(54) **WATER SCOOTER**

2004/0007167 A1* 1/2004 Cassell 114/55.57
2004/0168622 A1* 9/2004 Thompson et al. 114/55.5

(75) Inventors: **Toshiyuki Hattori**, Shizuoka-ken (JP);
Yoshiyuki Kaneko, Shizuoka-ken (JP)

* cited by examiner

(73) Assignee: **Yamaha Marine Kabushiki Kaisha**
(JP)

Primary Examiner—Holly H. Baynham

Assistant Examiner—Cynthia M. Chin

(74) *Attorney, Agent, or Firm*—Ostrolenk, Faber, Gerb &
Soffen, LLP

(**) Term: **14 Years**

(21) Appl. No.: **29/282,330**

(57) **CLAIM**

(22) Filed: **Jul. 17, 2007**

The ornamental design for a water scooter, as shown.

(51) **LOC (8) Cl.** **12-06**

(52) **U.S. Cl.** **D12/307**

(58) **Field of Classification Search** D12/300,
D12/307, 317; 114/55.5, 55.51–55.58
See application file for complete search history.

DESCRIPTION

FIG. 1 is a front, right side top perspective view of a water scooter showing our new design;

FIG. 2 is a left side view thereof;

FIG. 3 is a right side view thereof;

FIG. 4 is a front view thereof;

FIG. 5 is a rear view thereof;

FIG. 6 is a top view thereof; and,

FIG. 7 is a bottom view thereof.

(56) **References Cited**

U.S. PATENT DOCUMENTS

D343,160 S *	1/1994	LaPointe	D12/307
D483,315 S *	12/2003	Aselton et al.	D12/307
D510,900 S *	10/2005	Bucaccio et al.	D12/307
D516,006 S *	2/2006	Bucaccio et al.	D12/307
D517,466 S *	3/2006	Bucaccio et al.	D12/307

1 Claim, 4 Drawing Sheets

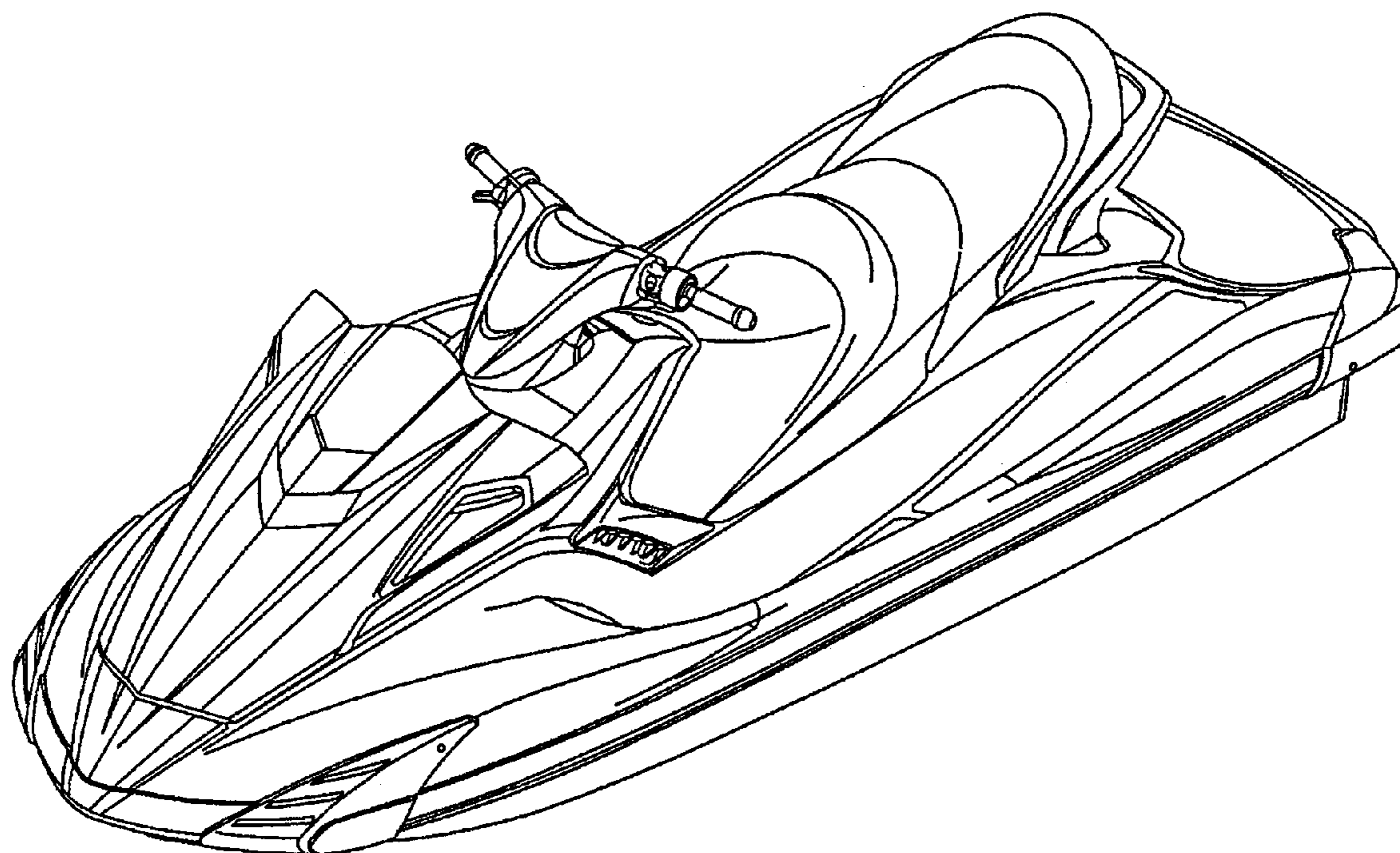

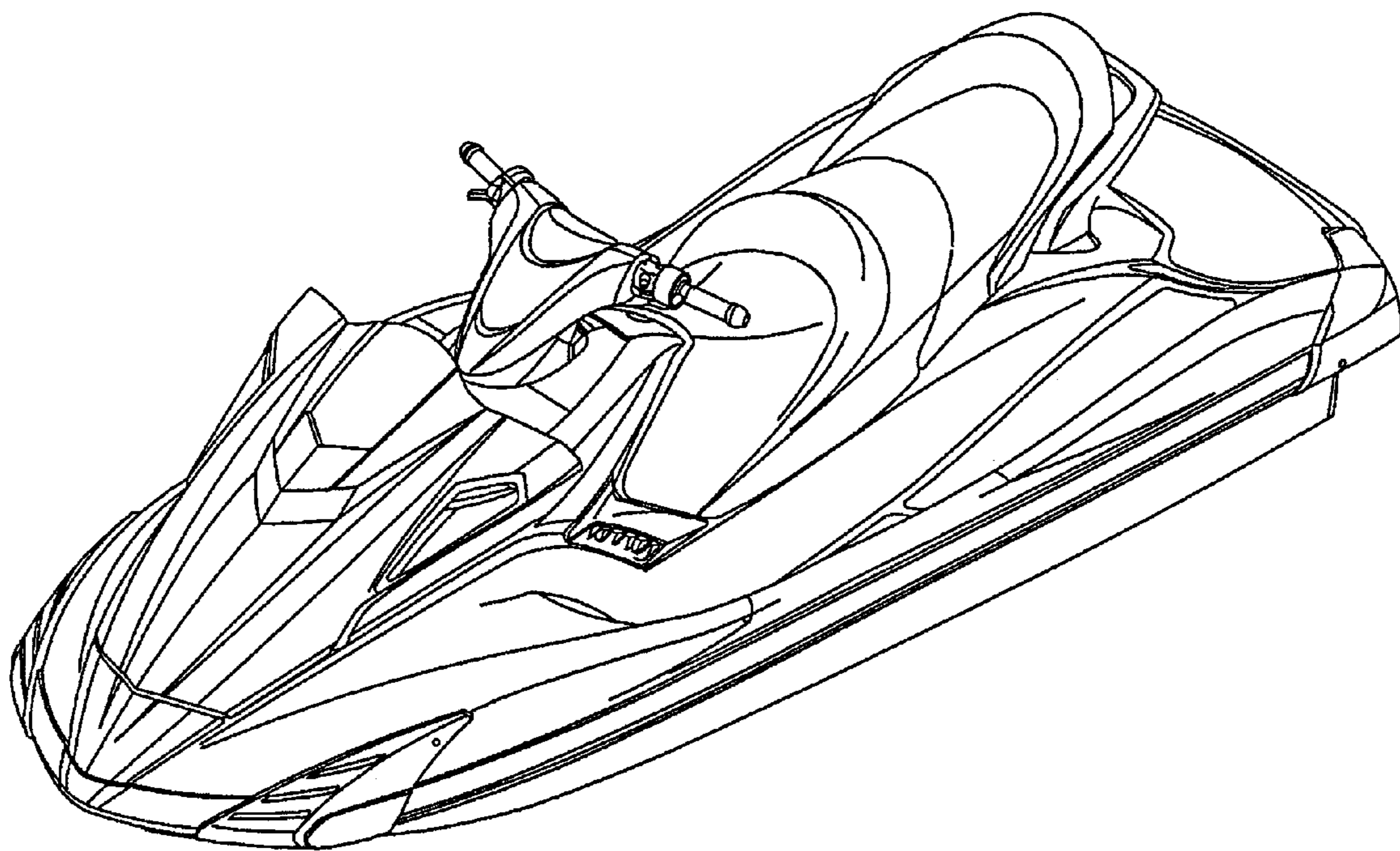

FIG. 1

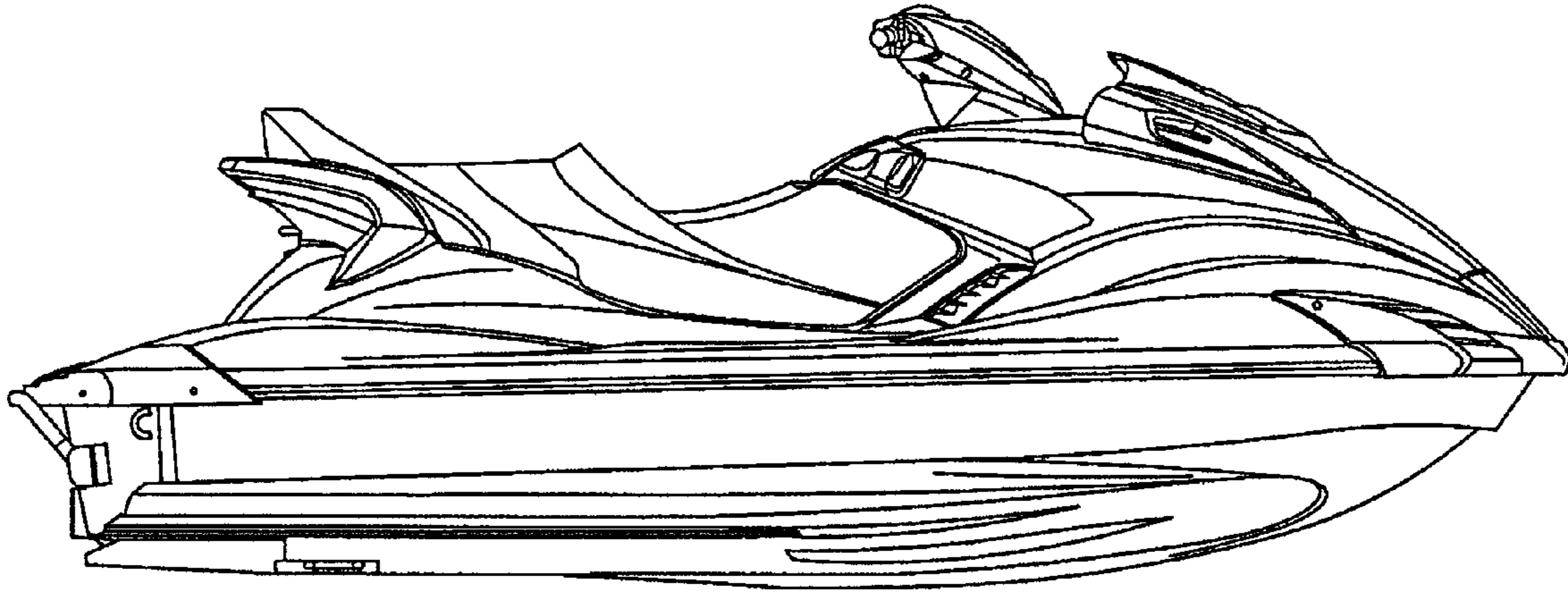

FIG. 2

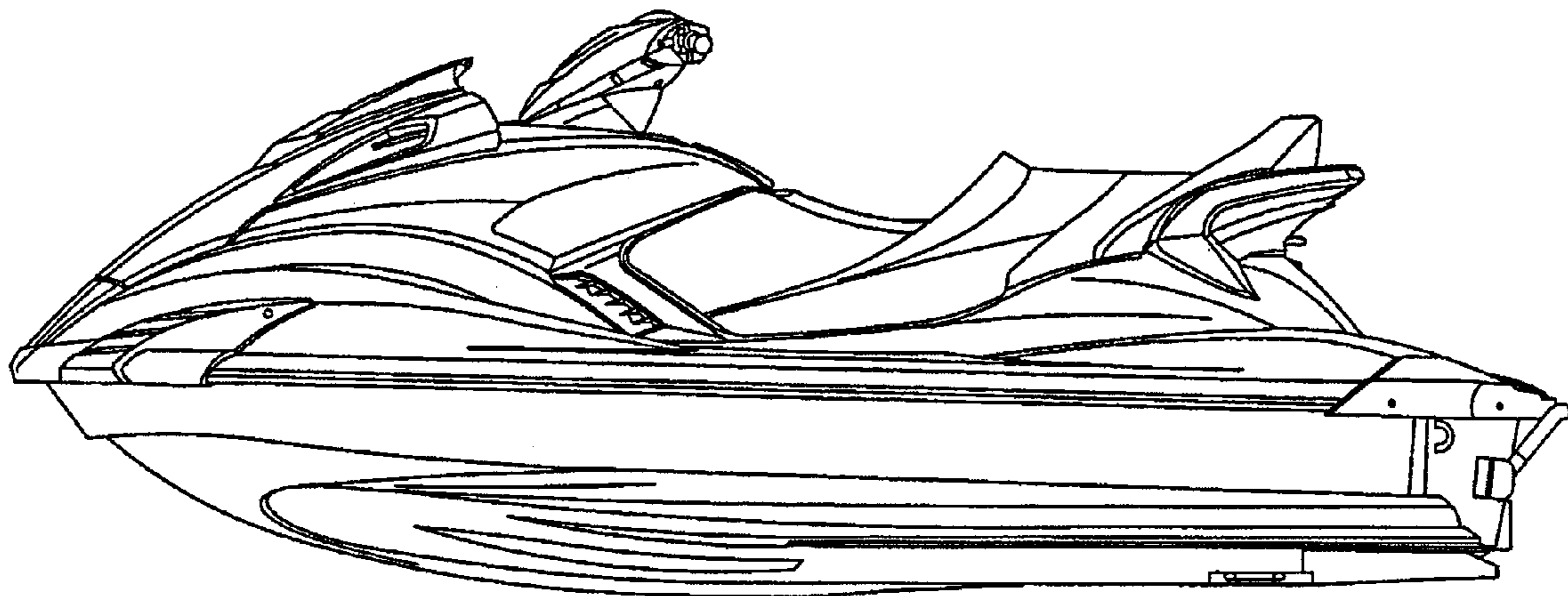

FIG. 3

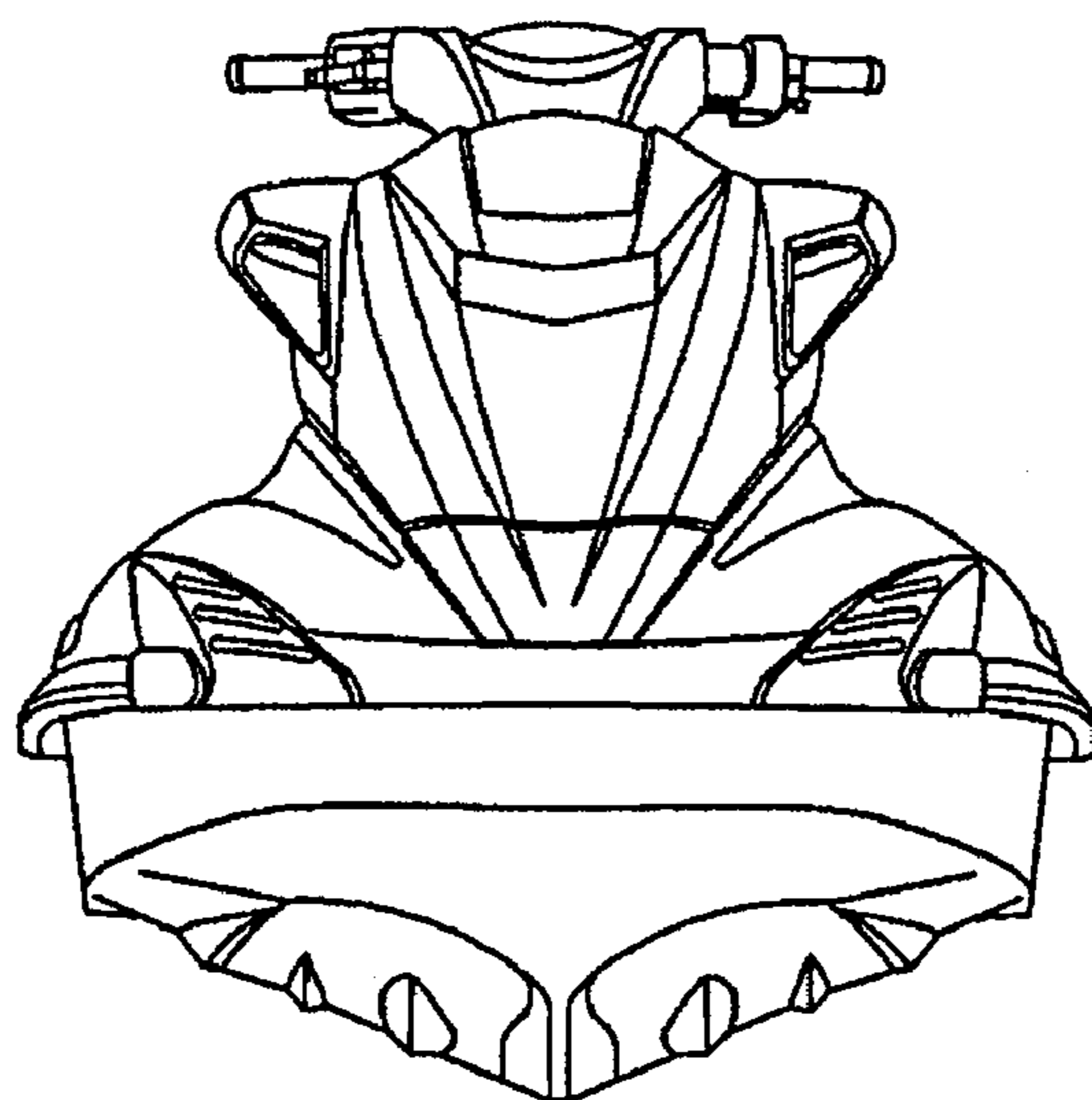

FIG. 4

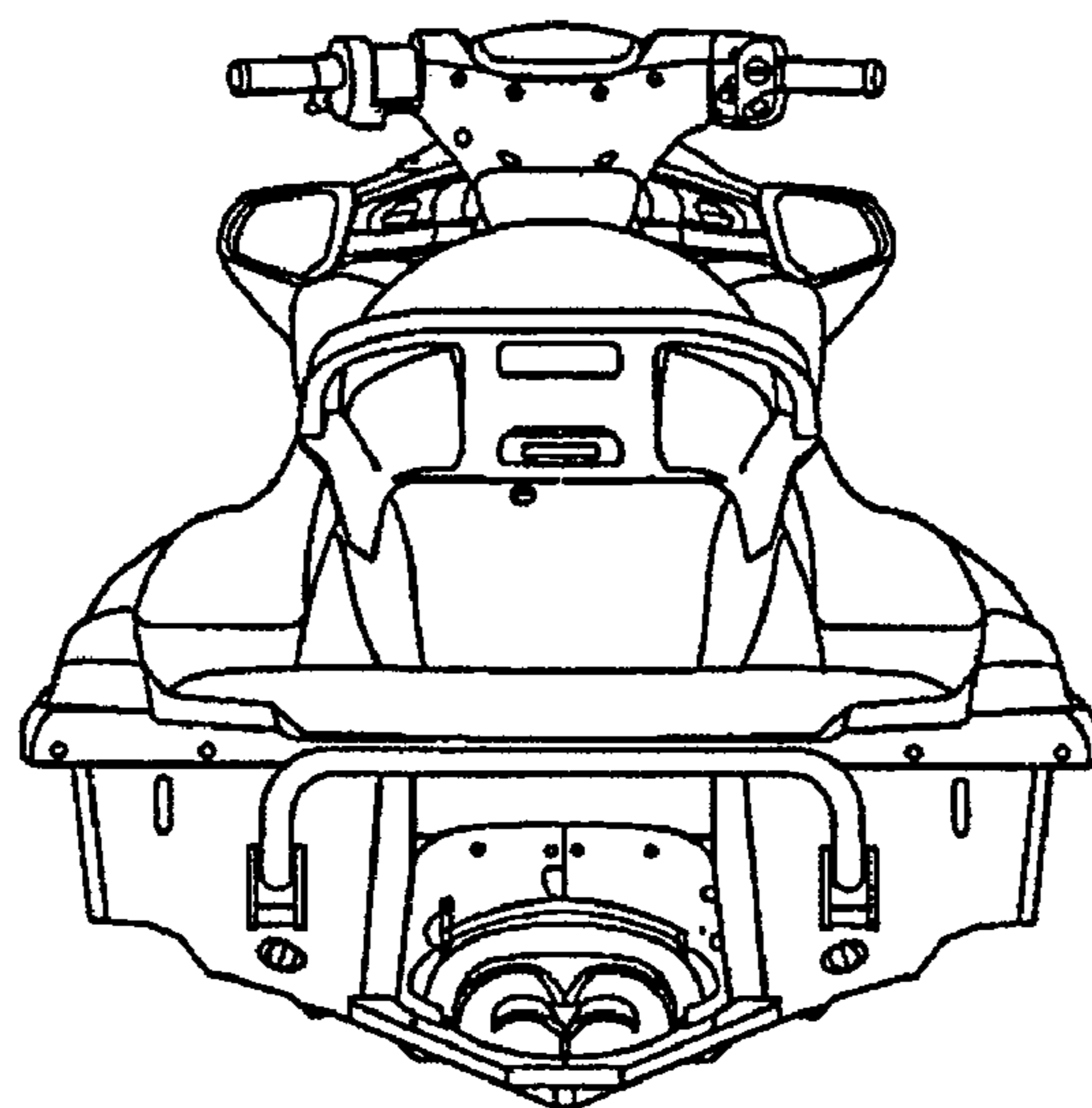

FIG. 5

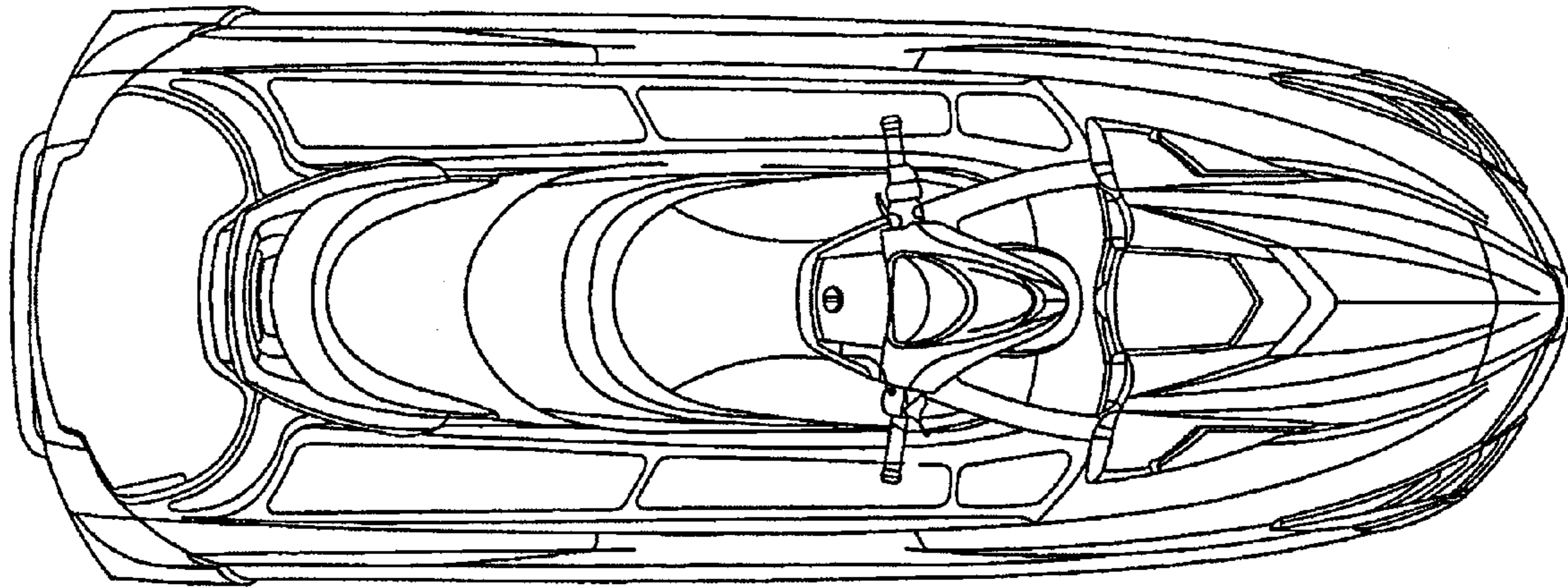

FIG. 6

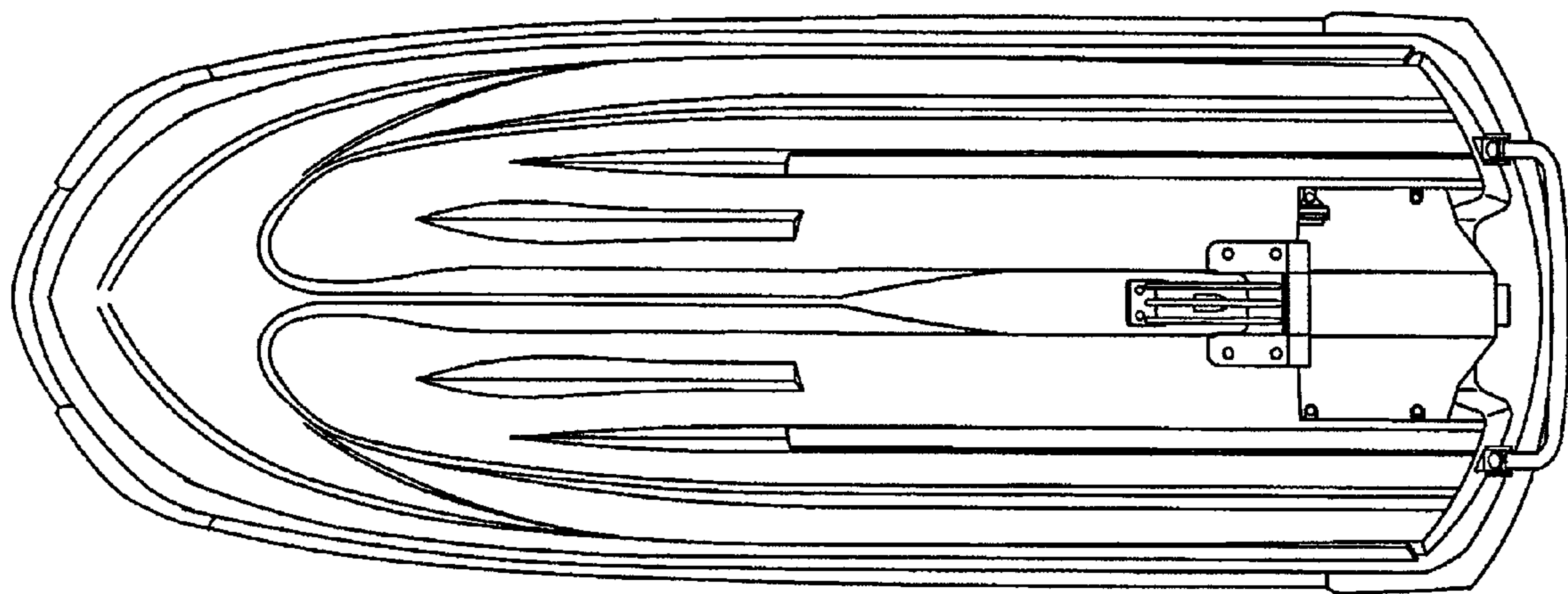

FIG. 7