



US00D569708S

(12) **United States Design Patent**
Wolf

(10) **Patent No.:** **US D569,708 S**

(45) **Date of Patent:** **** May 27, 2008**

(54) **SASH RAIL LOCK**

(75) Inventor: **Glen Wolf**, Owatonna, MN (US)

(73) Assignee: **Truth Hardware Corporation**,
Owatonna, MN (US)

(**) Term: **14 Years**

(21) Appl. No.: **29/279,463**

(22) Filed: **May 1, 2007**

(51) **LOC (8) Cl.** **08-07**

(52) **U.S. Cl.** **D8/337**

(58) **Field of Classification Search** D8/301,
D8/302, 308, 330, 331, 333, 336-339, 341,
D8/342, 343, 349; 70/89, 90, 287; 292/60,
292/108, 111, 132, 139, 145, 169, 202, 228,
292/240, 241, 242, 258; 49/181, 183, 185,
49/192, 503

See application file for complete search history.

(56) **References Cited**

U.S. PATENT DOCUMENTS

4,050,724 A	9/1977	Nakanishi	
4,063,766 A	12/1977	Granberg	
D248,617 S	7/1978	Cavalucci	
D249,017 S	8/1978	Costello	
D268,643 S *	4/1983	Anderson D8/337
D293,548 S	1/1988	Bates et al.	
D295,948 S	5/1988	Mandell	
D316,509 S	4/1991	Nolte	
D334,132 S	3/1993	Wobschall et al.	
D350,275 S	9/1994	Olsen et al.	
D366,409 S	1/1996	Delaske	
D369,290 S	4/1996	Subliskey	
5,582,445 A	12/1996	Olsen et al.	
D380,957 S	7/1997	Evans et al.	
D382,191 S	8/1997	Plummer	
D382,192 S	8/1997	Plummer	
D408,263 S	4/1999	Briggs	

(Continued)

Primary Examiner—Stella M. Reid

Assistant Examiner—Shanda C. Hill

(74) *Attorney, Agent, or Firm*—Patterson, Thunte, Skaar & Christensen PA

(57) **CLAIM**

I claim the ornamental design for sash rail lock, as shown.

DESCRIPTION

FIG. 1 is a front perspective view of a sash rail lock according to a first embodiment of the invention;

FIG. 2 is a top plan view of the sash rail lock depicted in FIG. 1;

FIG. 3 is a side elevation view of the sash rail lock depicted in FIG. 1;

FIG. 4 is a rear elevation view of the sash rail lock depicted in FIG. 1;

FIG. 5 is an opposing side elevation view of the sash rail lock depicted in FIG. 1;

FIG. 6 is a front elevation view of the sash rail lock depicted in FIG. 1;

FIG. 7 is a front perspective view of a sash rail lock according to a second embodiment of the invention;

FIG. 8 is a top plan view of the sash rail lock depicted in FIG. 7;

FIG. 9 is a side elevation view of the sash rail lock depicted in FIG. 7;

FIG. 10 is a rear elevation view of the sash rail lock depicted in FIG. 7;

FIG. 11 is an opposing side elevation view of the sash rail lock depicted in FIG. 7; and,

FIG. 12 is a front elevation view of the sash rail lock depicted in FIG. 7.

The broken lines shown in the drawing disclosure are for illustrative purposes only and form no part of the claimed design.

1 Claim, 2 Drawing Sheets

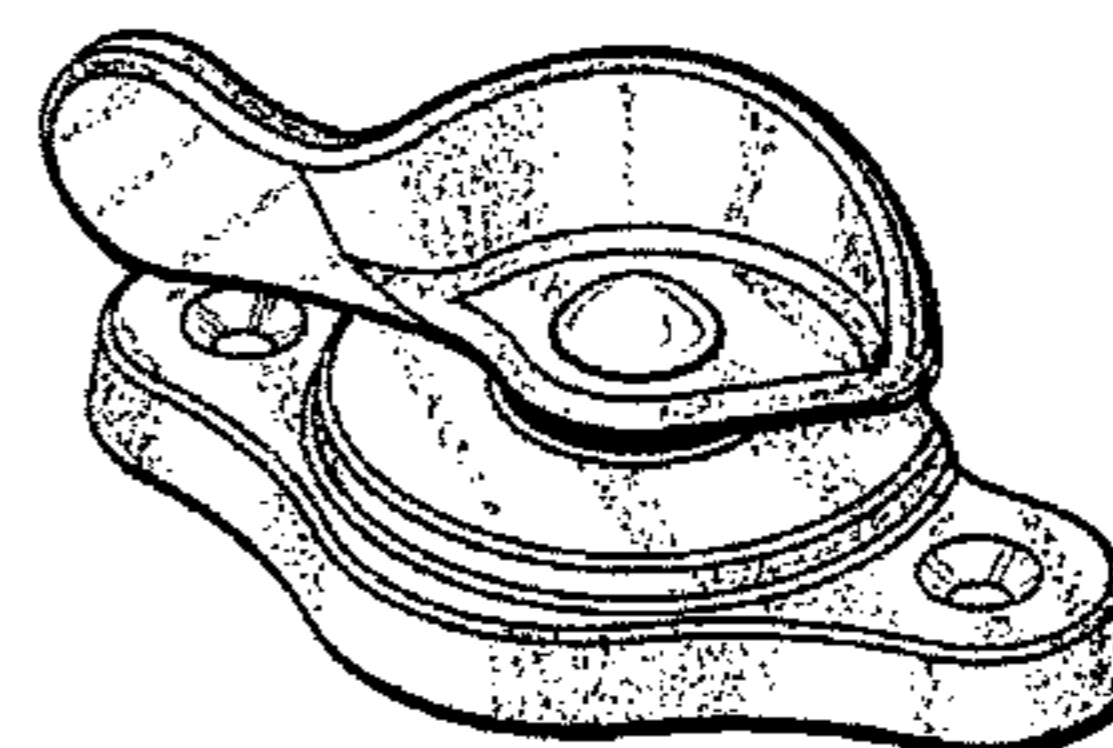
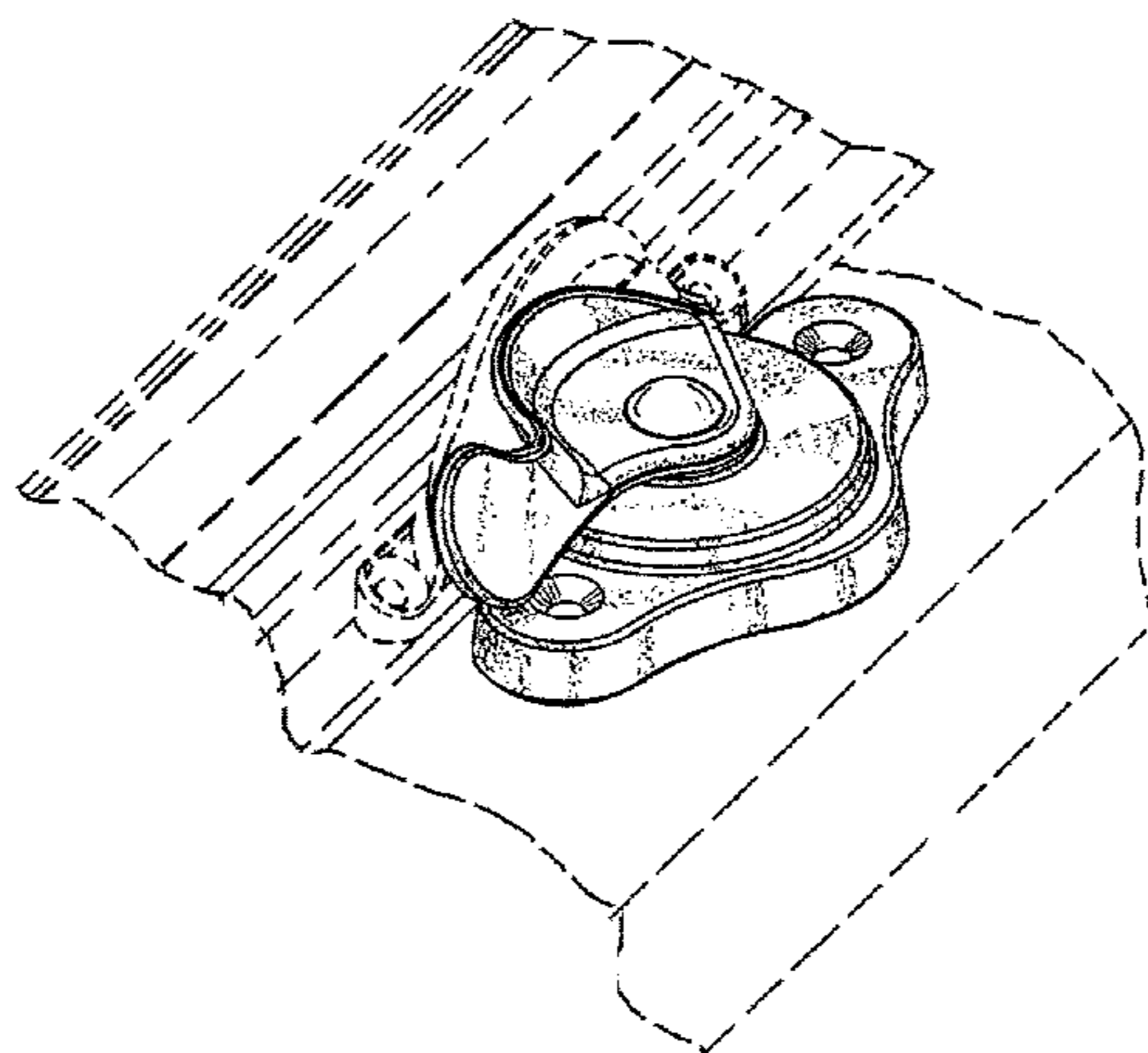

US D569,708 S

Page 2

U.S. PATENT DOCUMENTS

D418,737 S	1/2000	Libby et al.	D560,112 S *	1/2008	Baczuk et al.	D8/337
6,568,723 B2	5/2003	Murphy et al.	2003/0057717 A1	3/2003	Murphy et al.	
6,871,886 B2	3/2005	Coleman et al.	2003/0151262 A1	8/2003	Murphy et al.	
6,983,963 B2	1/2006	Eslick et al.	2003/0155777 A1	8/2003	Eslick et al.	
D536,950 S	2/2007	Liang et al.	2004/0026932 A1	2/2004	Coleman et al.	
D546,166 S	7/2007	Liang	2007/0085350 A1	4/2007	Liang et al.	
D553,950 S	10/2007	Flory	2007/0200363 A1*	8/2007	Eenigenburg et al.	292/240
D554,973 S	11/2007	Flory	2007/0209281 A1	9/2007	Flory et al.	
7,296,831 B2	11/2007	Generowicz et al.				

* cited by examiner

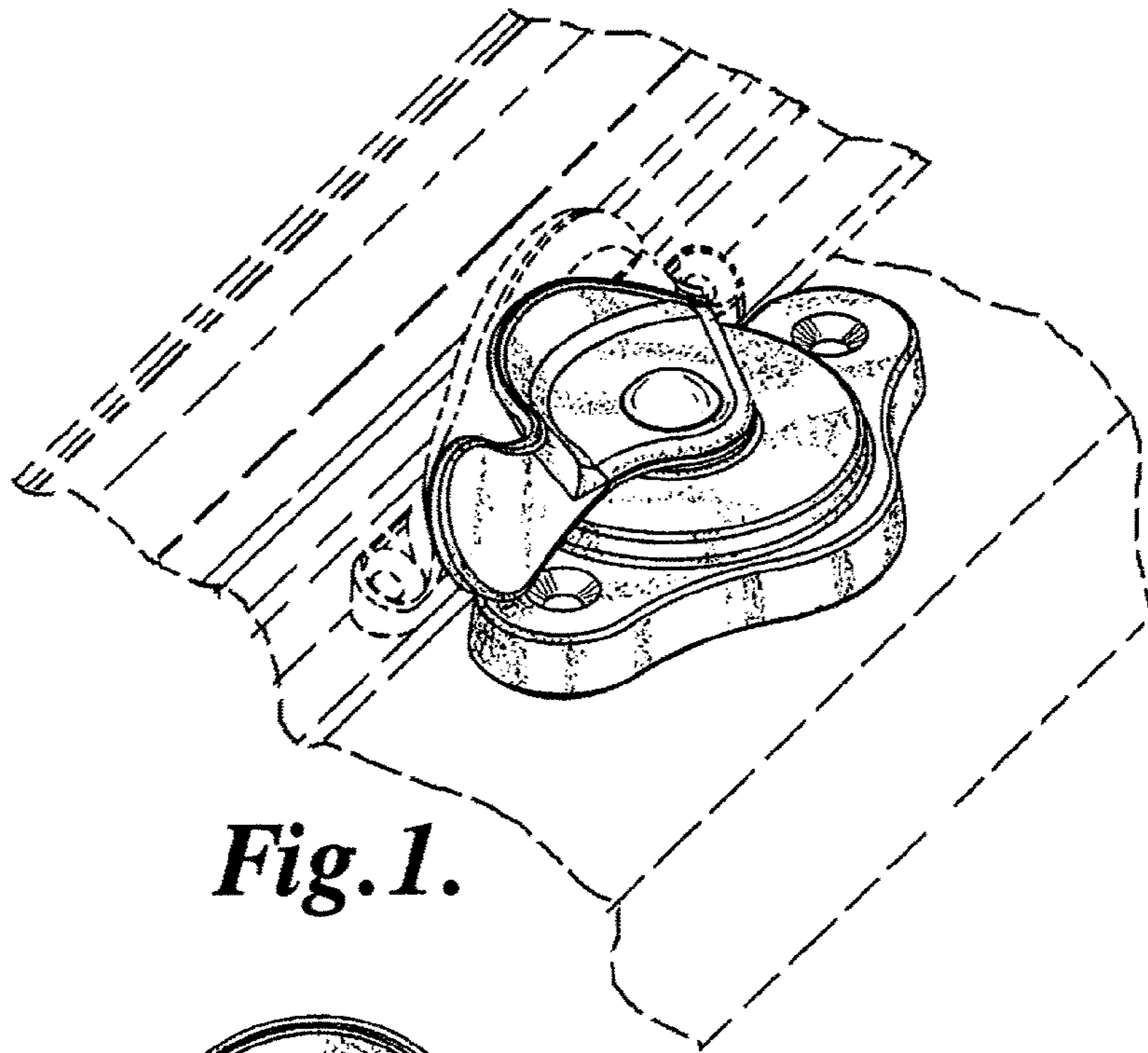

Fig. 1.

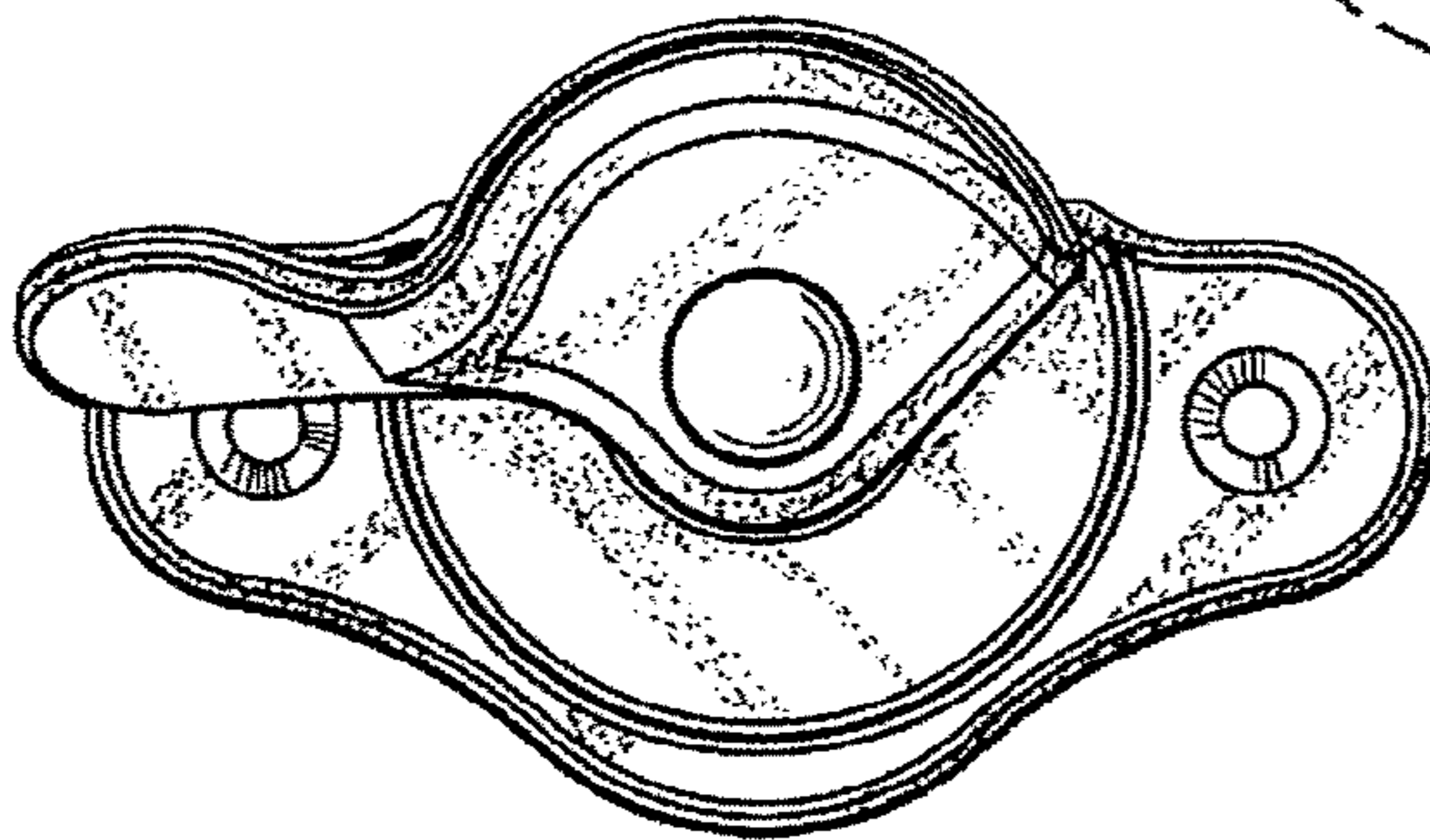

Fig. 2.

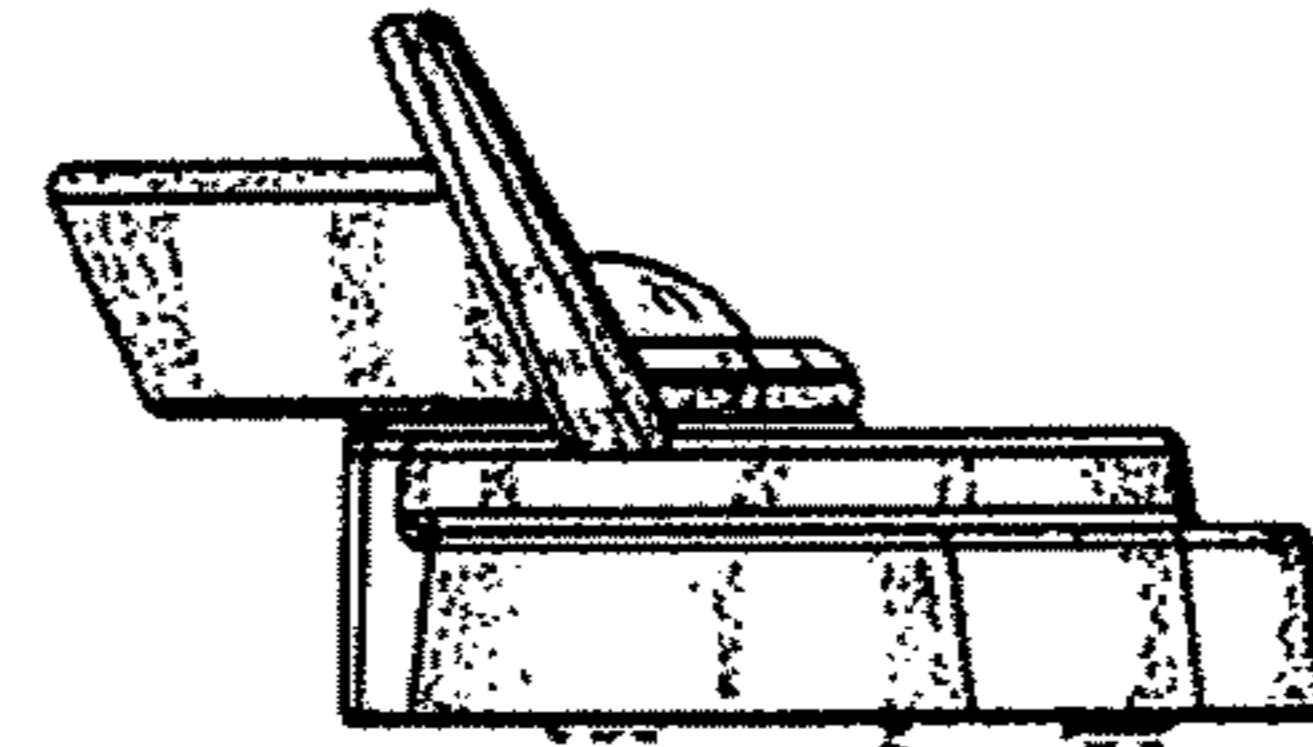

Fig. 3.

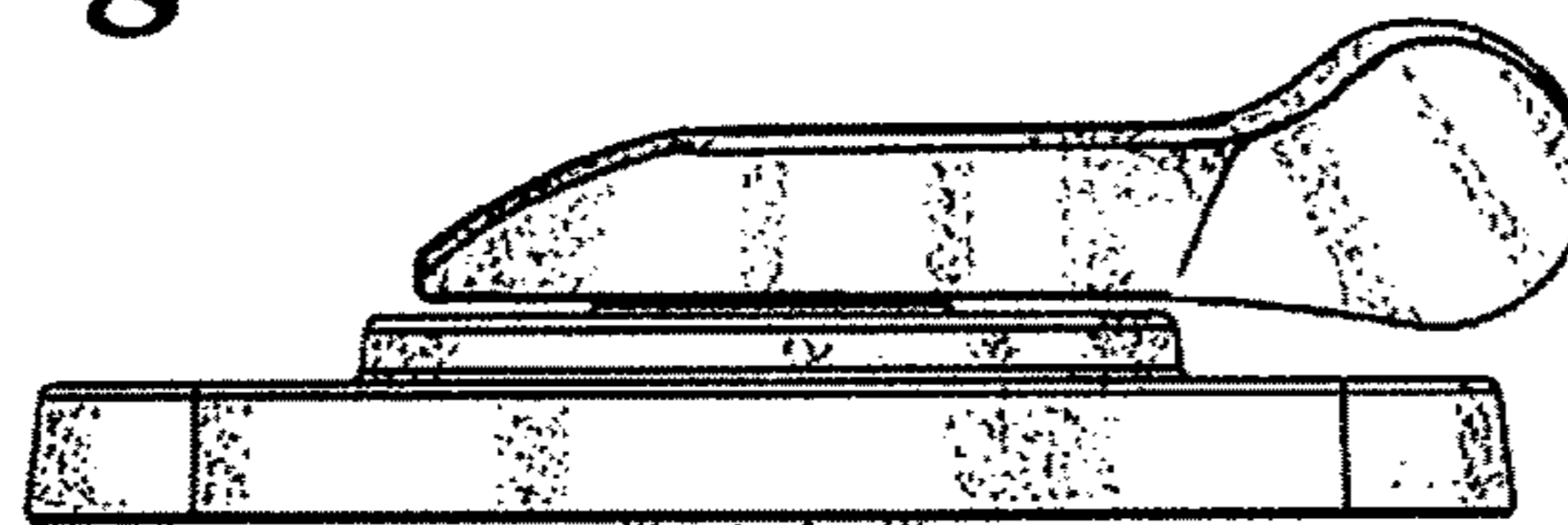

Fig. 4.

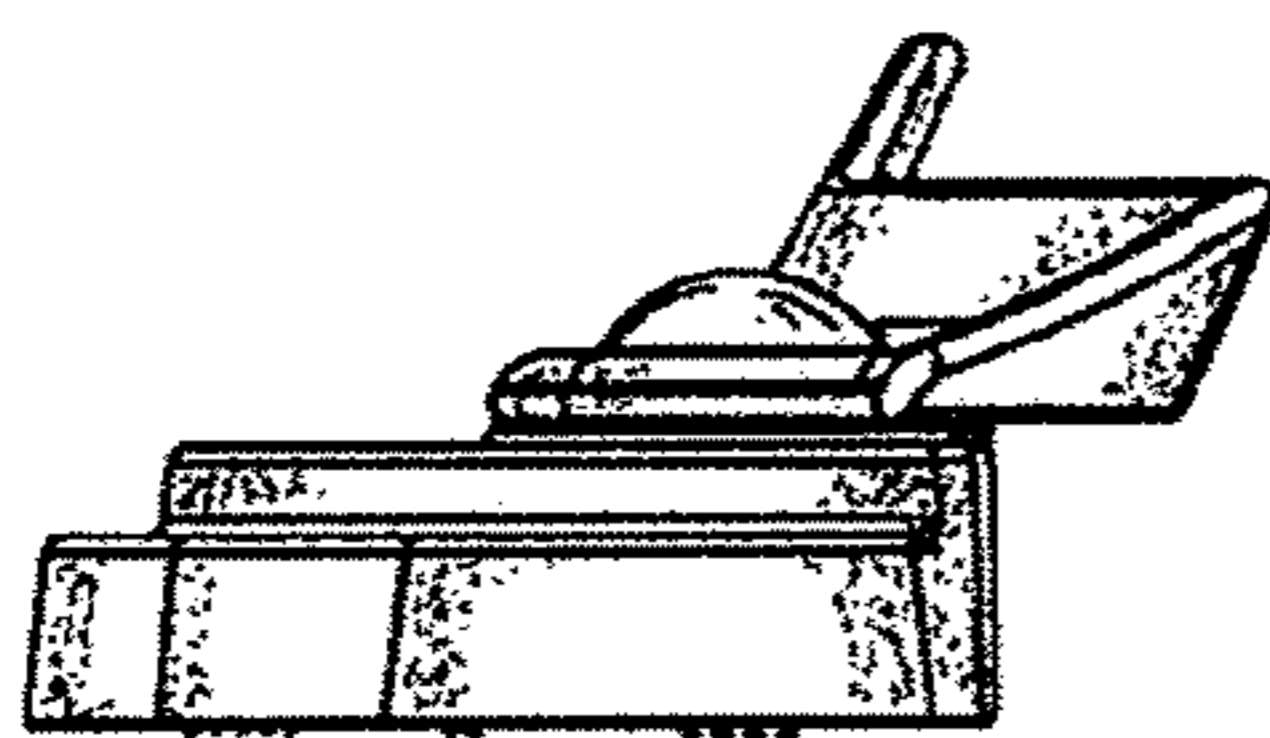

Fig. 5.

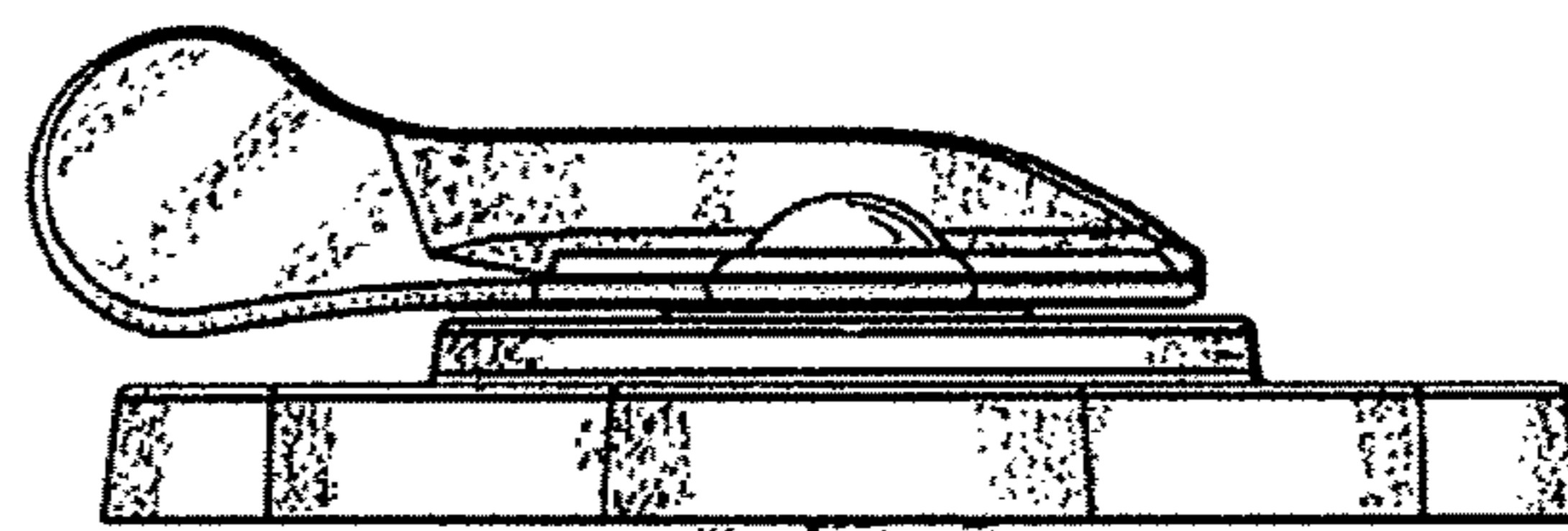

Fig. 6.

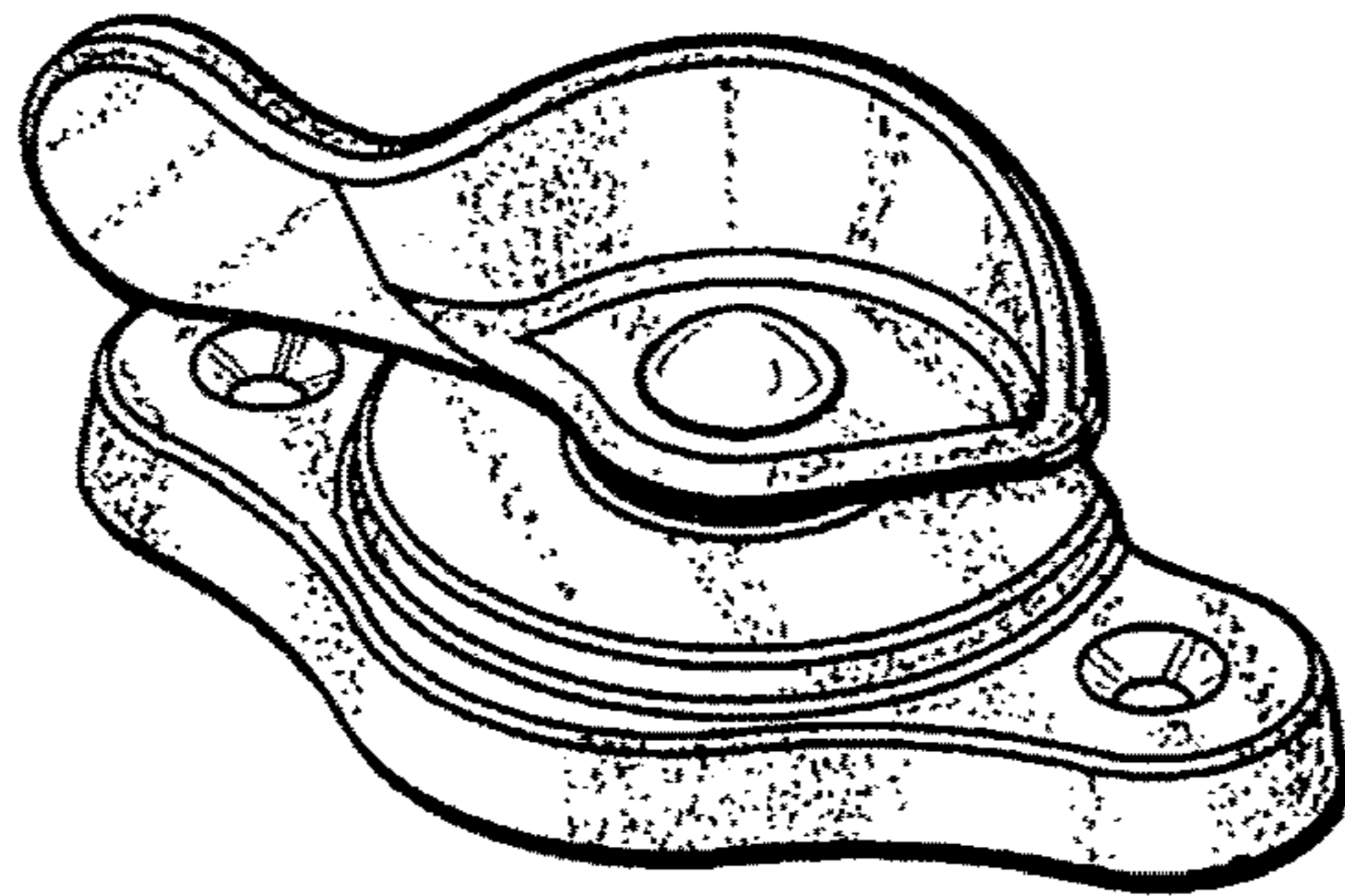

Fig. 7.

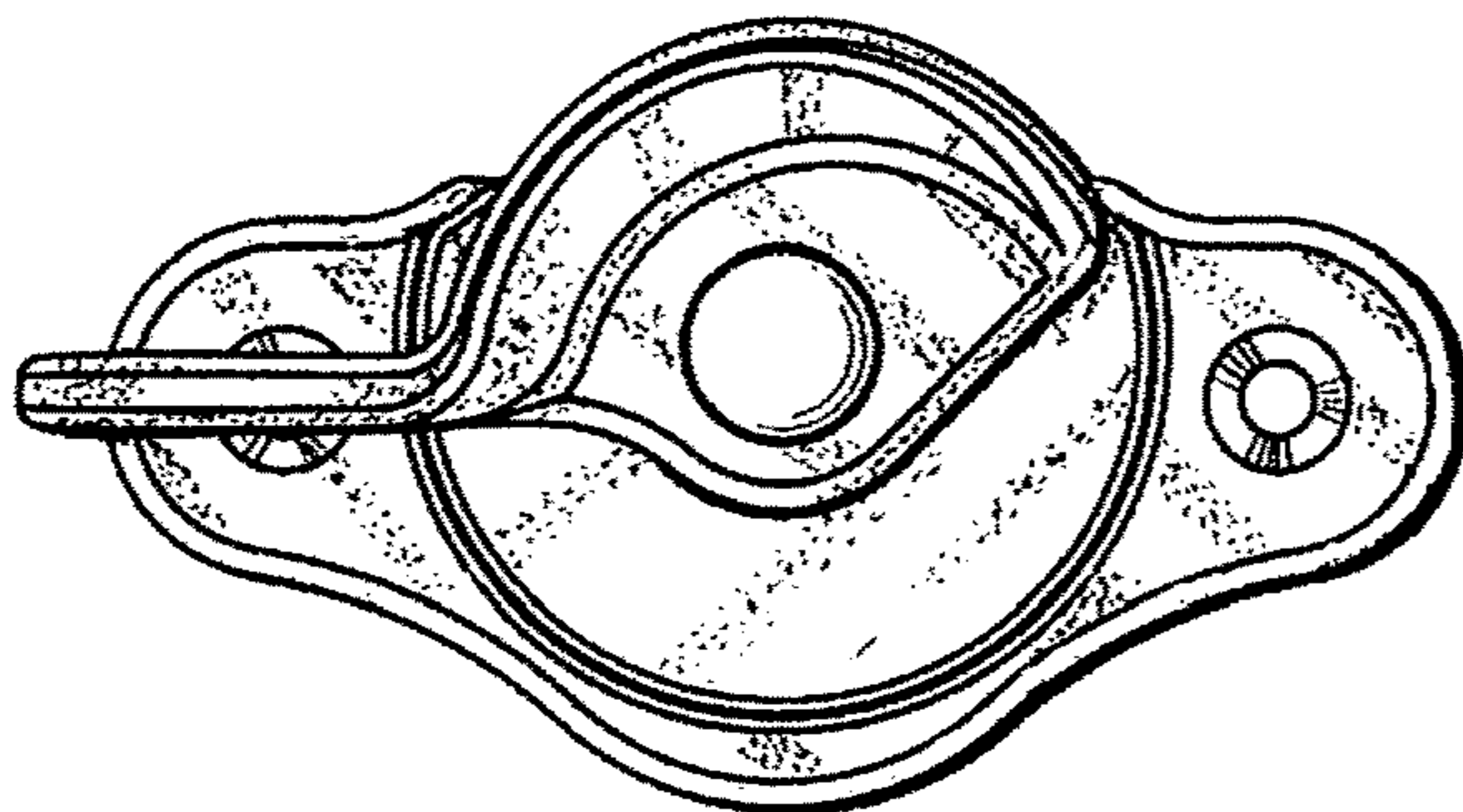

Fig. 8.

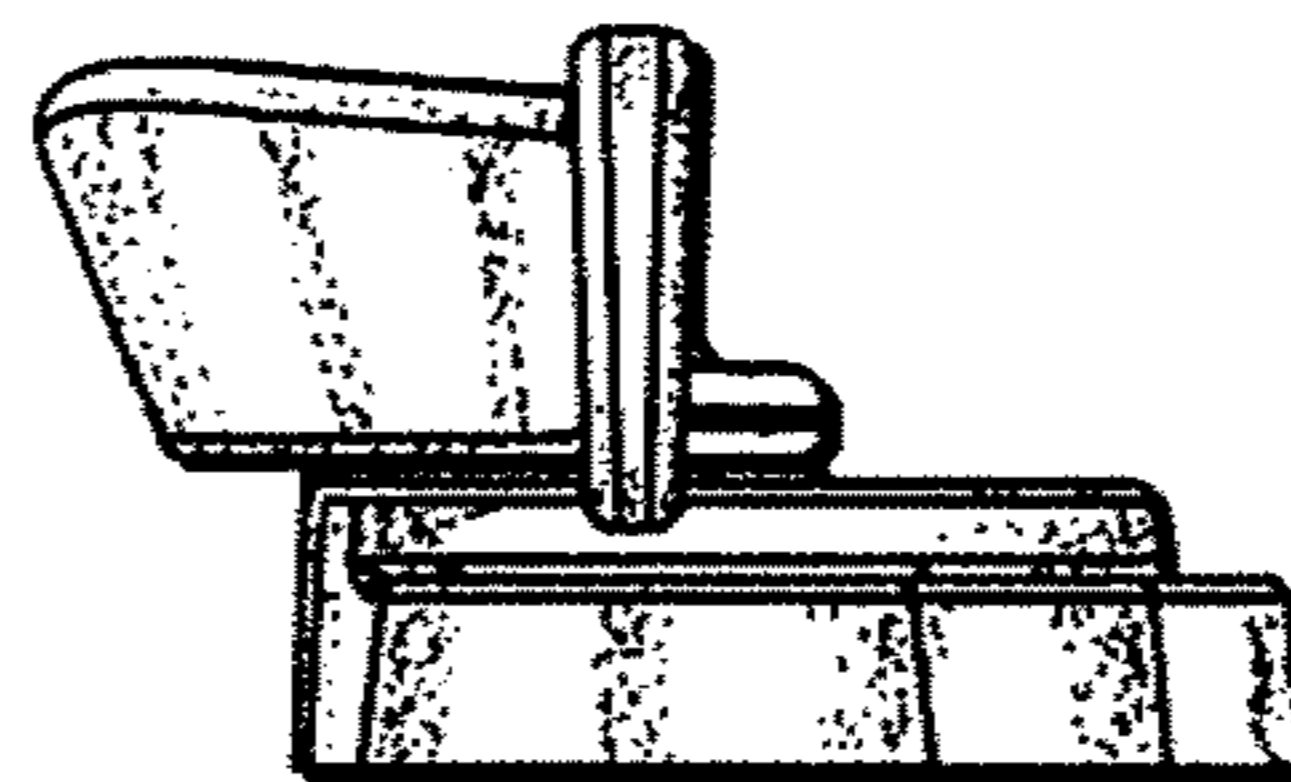

Fig. 9.

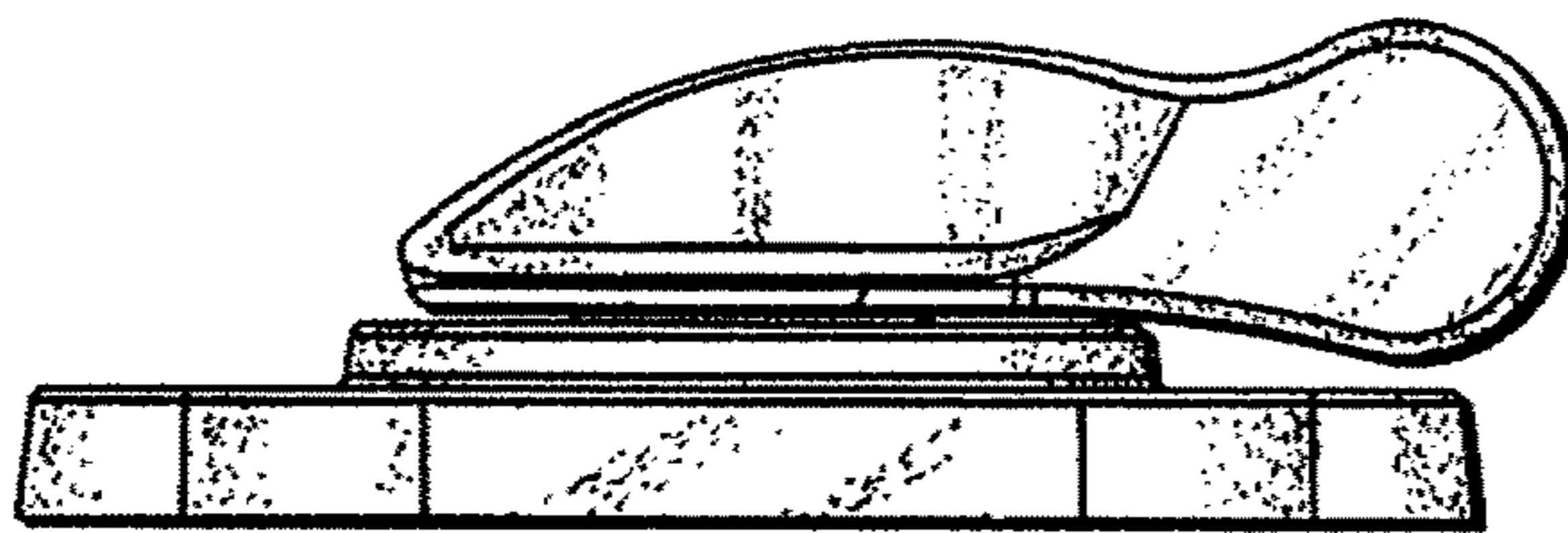

Fig. 10.

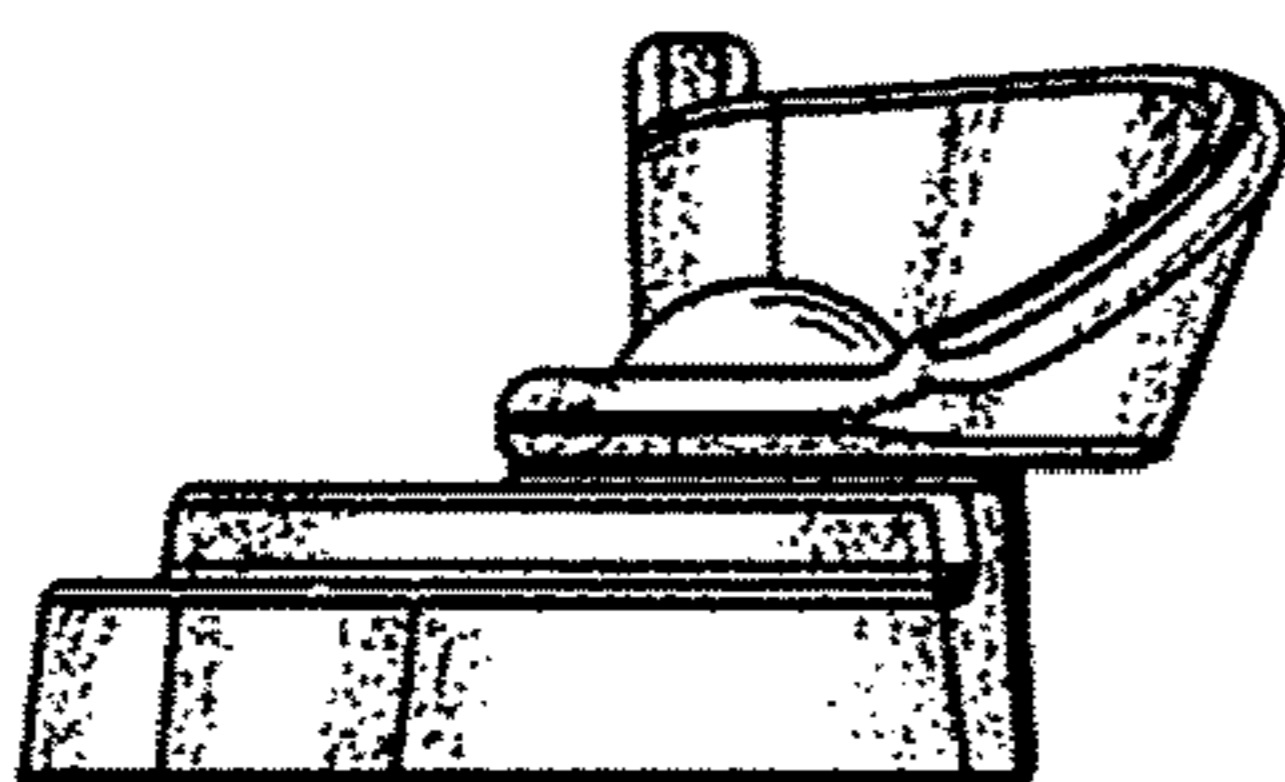

Fig. 11.

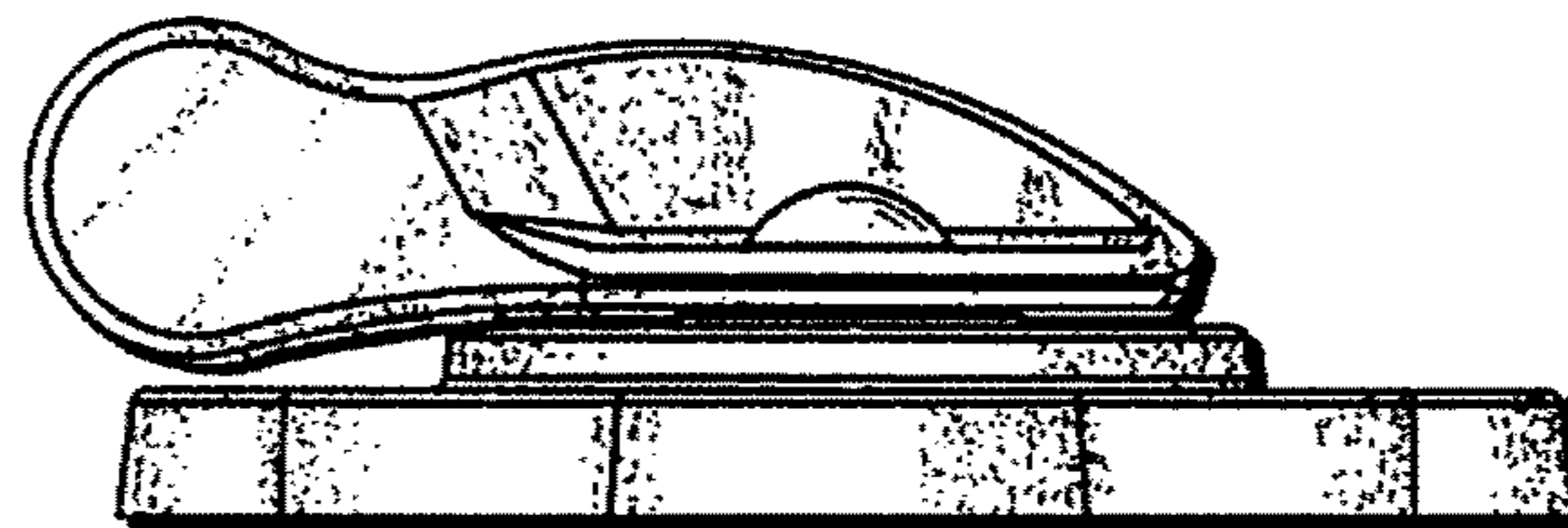

Fig. 12.