

US00D569666S

(12) **United States Design Patent**
Gusdorf

(10) **Patent No.:** **US D569,666 S**
(45) **Date of Patent:** **** May 27, 2008**

(54) **CEDAR LINED SUSPENDED SHELVING**

(57) **CLAIM**

(75) Inventor: **Michael L. Gusdorf**, St. Louis, MO
(US)

The ornamental design for cedar lined suspended shelving,
as shown and described.

(73) Assignee: **Industrial Wire Products, Inc.**,
Sullivan, MO (US)

DESCRIPTION

(**) Term: **14 Years**

FIG. 1 is an isometric view of cedar lined suspended shelving showing a first embodiment of my new design;

(21) Appl. No.: **29/288,447**

FIG. 2 is a front elevational view thereof;

(22) Filed: **Jun. 12, 2007**

FIG. 3 is a rear elevational view thereof;

(51) **LOC (8) Cl.** **06-06**

FIG. 4 is a right side elevational view thereof;

(52) **U.S. Cl.** **D6/514**

FIG. 5 is a left side elevational view thereof;

(58) **Field of Classification Search** D6/512-514,
D6/553, 567; 206/278, 9, 286, 289; 211/10,
211/131, 85.3, 113

FIG. 6 is a top plan view thereof;

See application file for complete search history.

FIG. 7 is a bottom plan view thereof;

(56) **References Cited**

FIG. 8 is an isometric view of the cedar lined suspended shelving in its collapsed state:

U.S. PATENT DOCUMENTS

FIG. 9 is isometric view of cedar lined suspended shelving showing a second embodiment of my new design;

4,295,432 A *	10/1981	Hulke	D6/514
D304,651 S *	11/1989	McKee	D6/514
D465,363 S *	11/2002	Ong	D6/514
D540,583 S *	4/2007	Greiner	D6/514
D547,579 S *	7/2007	Greiner	D6/514
D551,473 S *	9/2007	Greiner	D6/514

FIG. 10 is a front view thereof;

FIG. 11 is a rear view thereof;

FIG. 12 is a right side view thereof;

FIG. 13 is a left side view thereof;

FIG. 14 is a top view thereof;

FIG. 15 is a bottom view thereof; and,

FIG. 16 is an isometric view of the cedar lined suspended shelving in its collapsed state.

* cited by examiner

Primary Examiner—Brian N Vinson

(74) *Attorney, Agent, or Firm*—Paul M. Denk

1 Claim, 8 Drawing Sheets

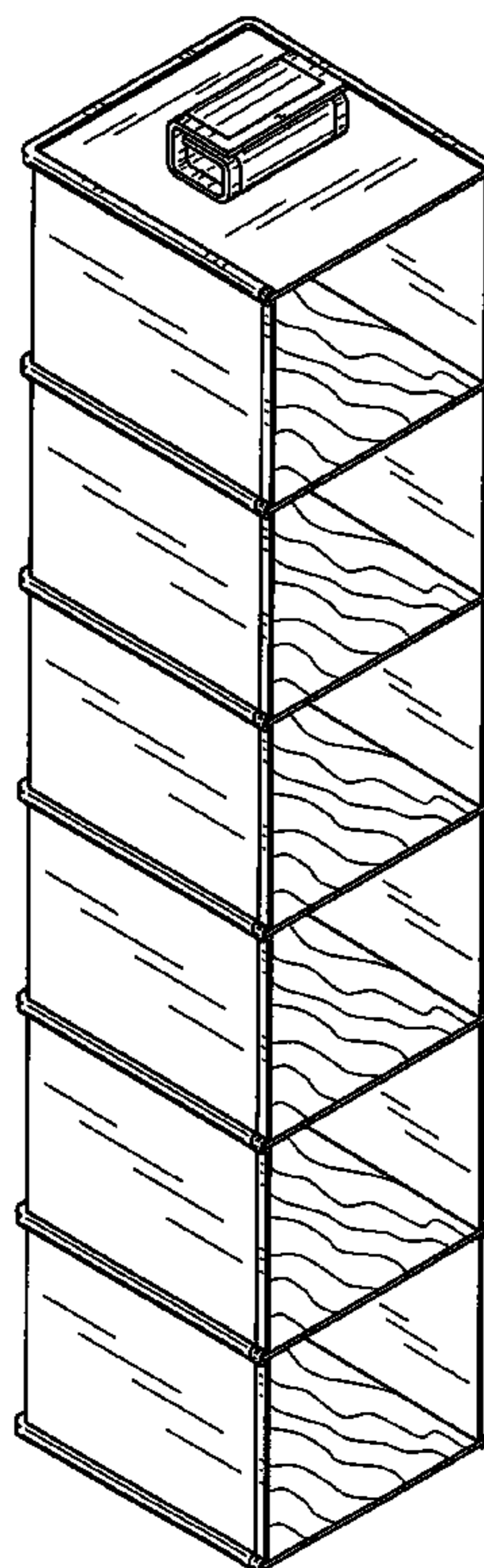

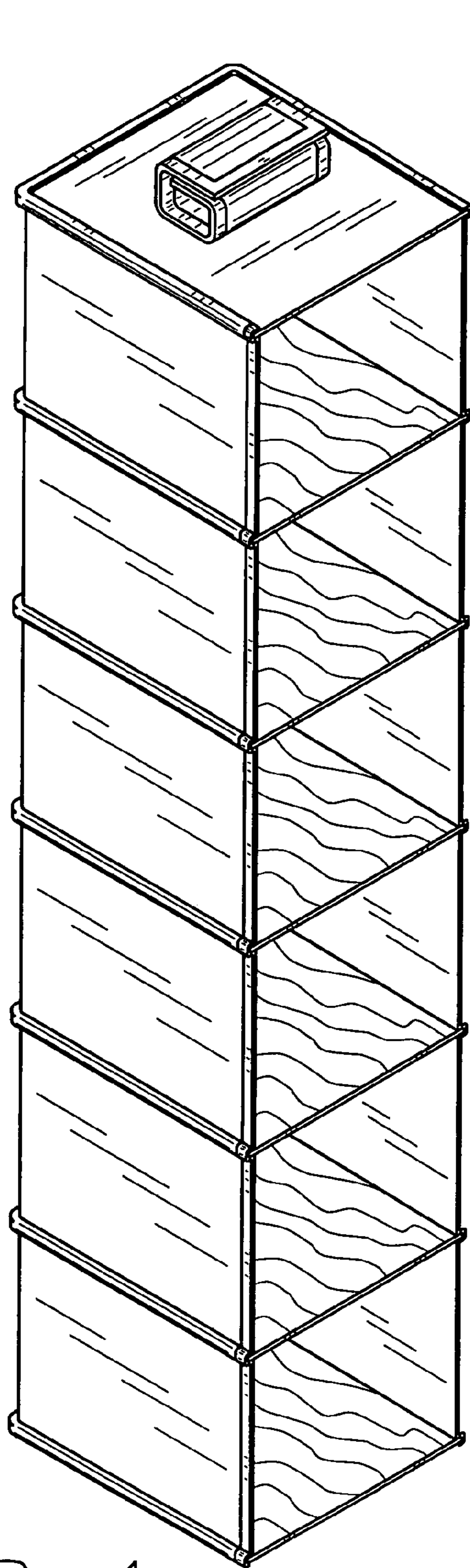

FIG. 1

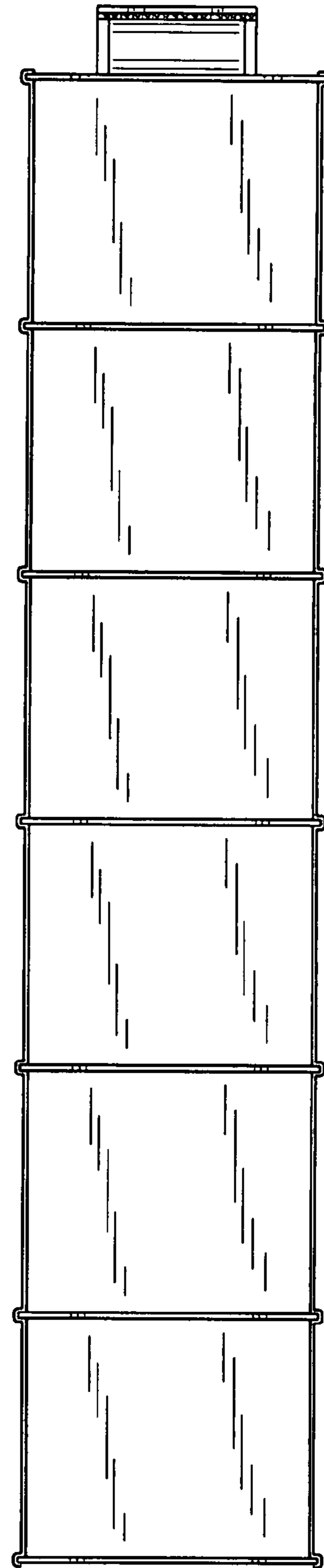

FIG. 2

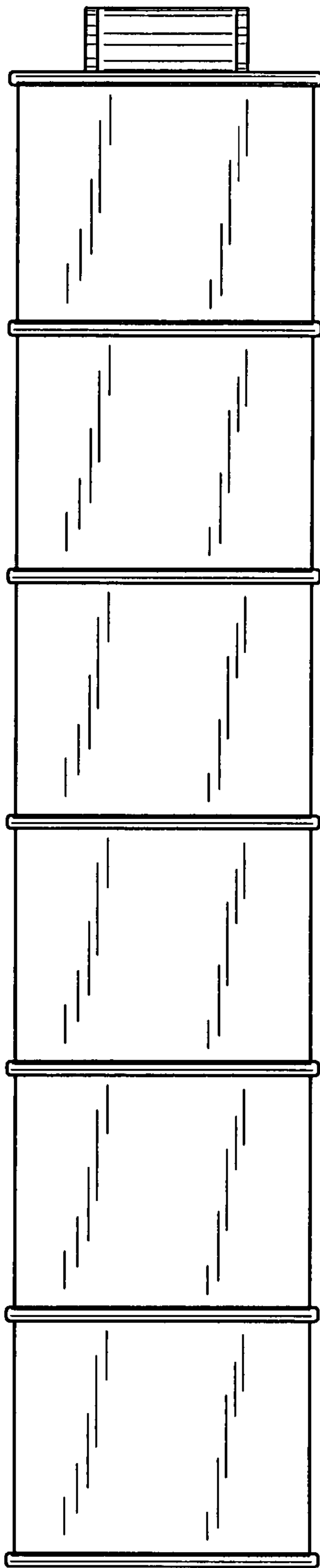

FIG. 3

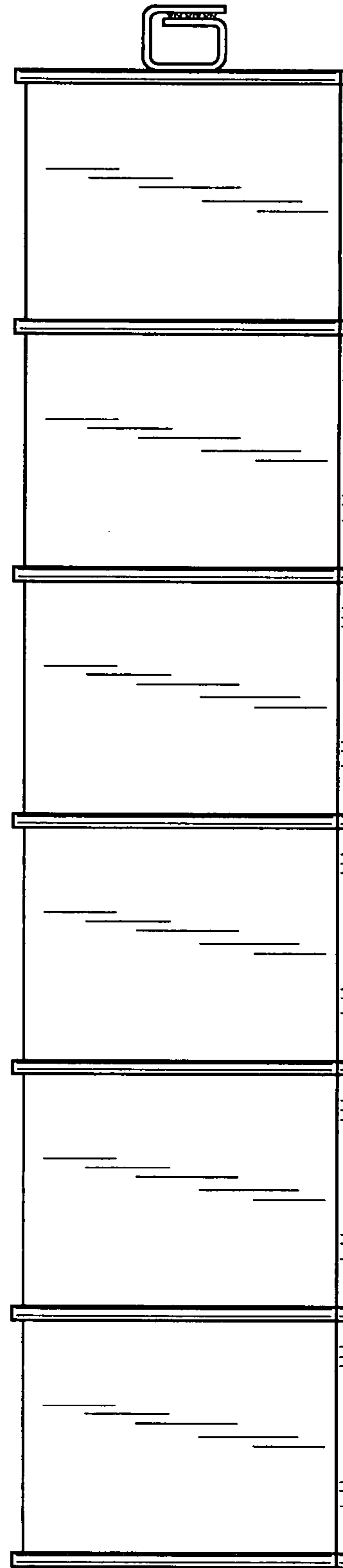

FIG. 4

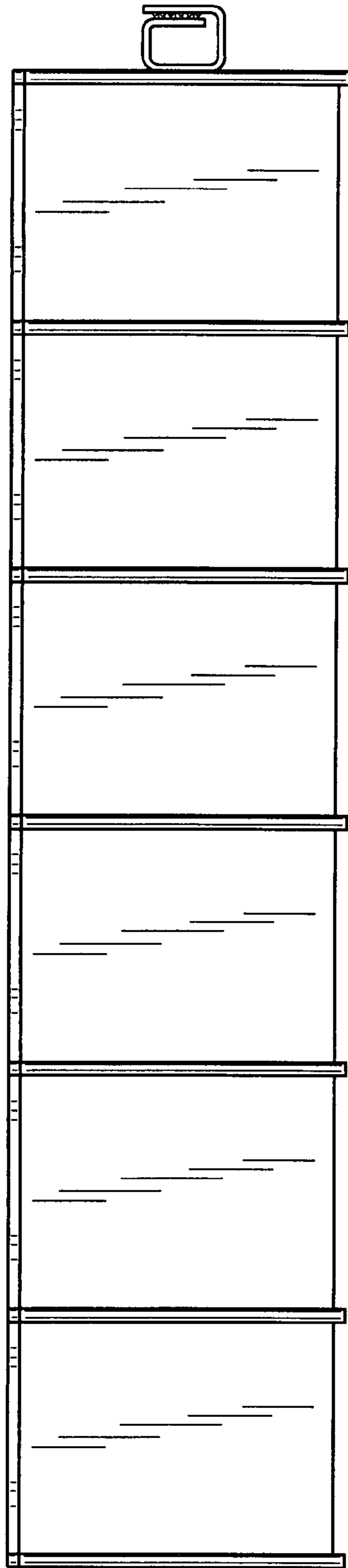

FIG. 5

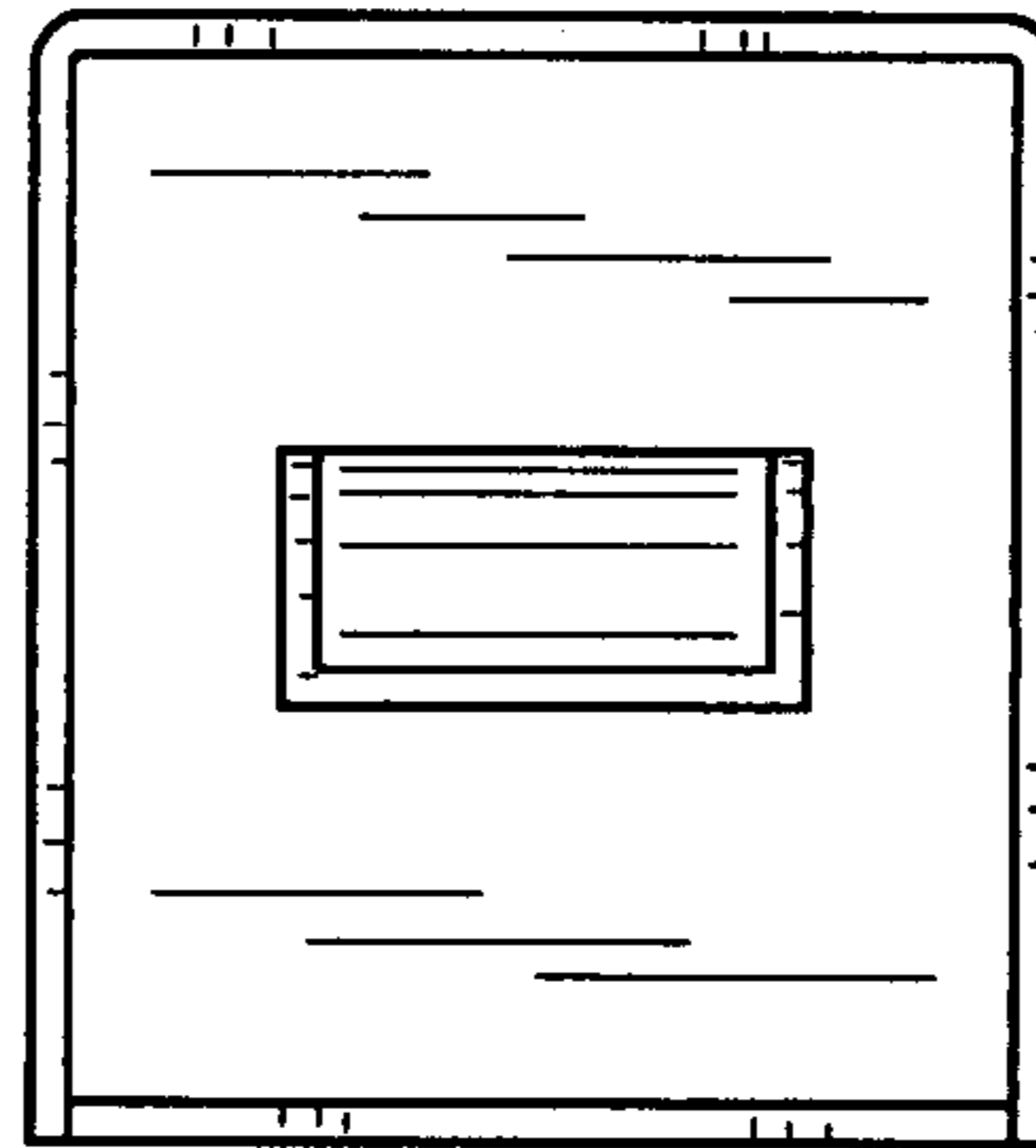

FIG. 6

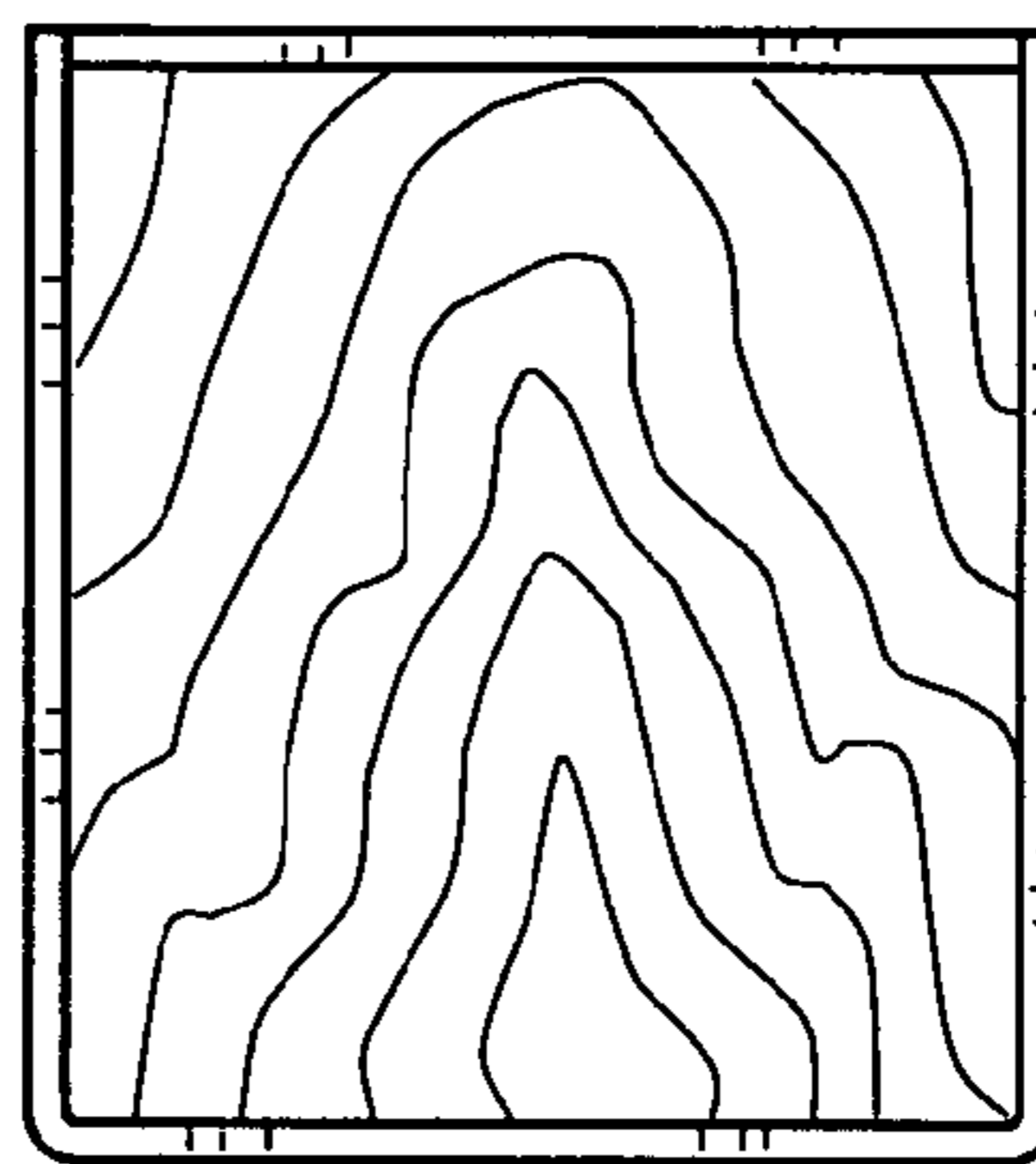

FIG. 7

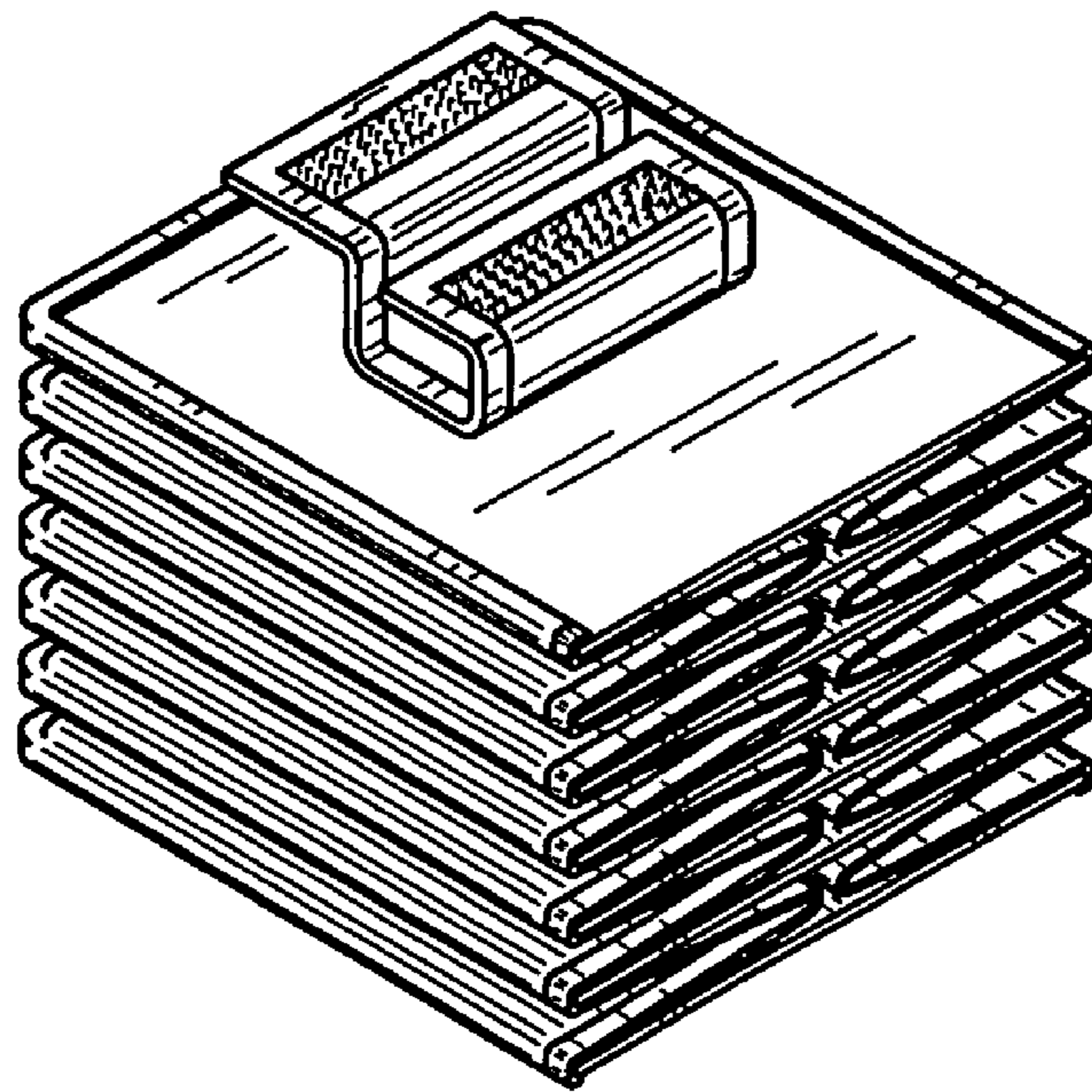

FIG. 8

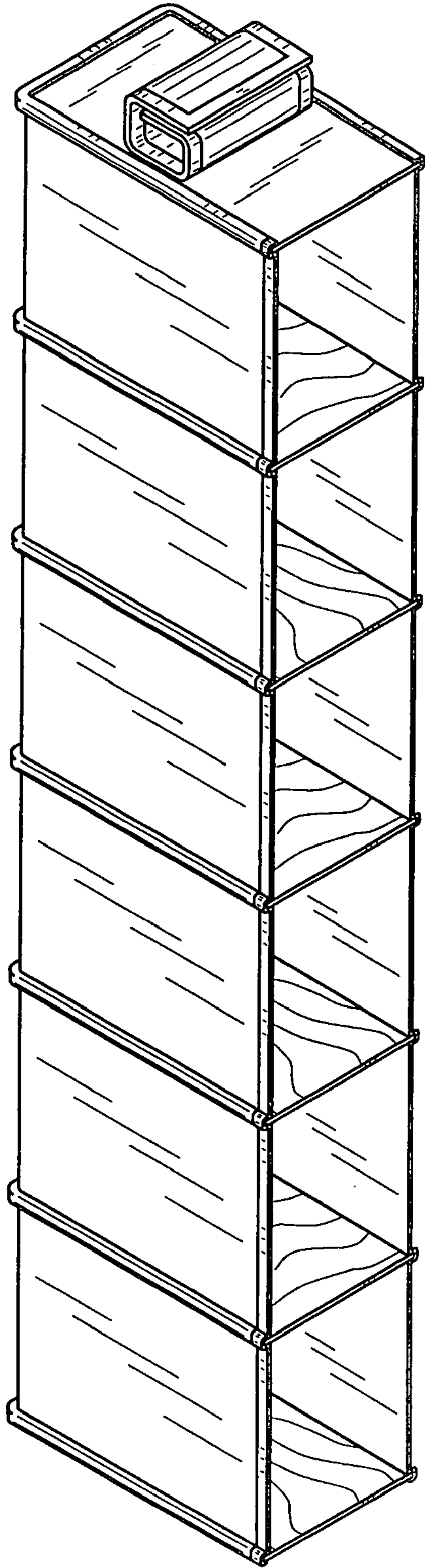

FIG. 9

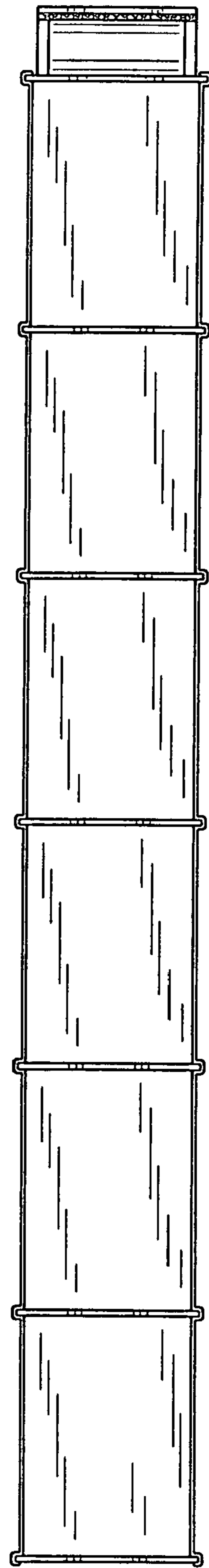

FIG. 10

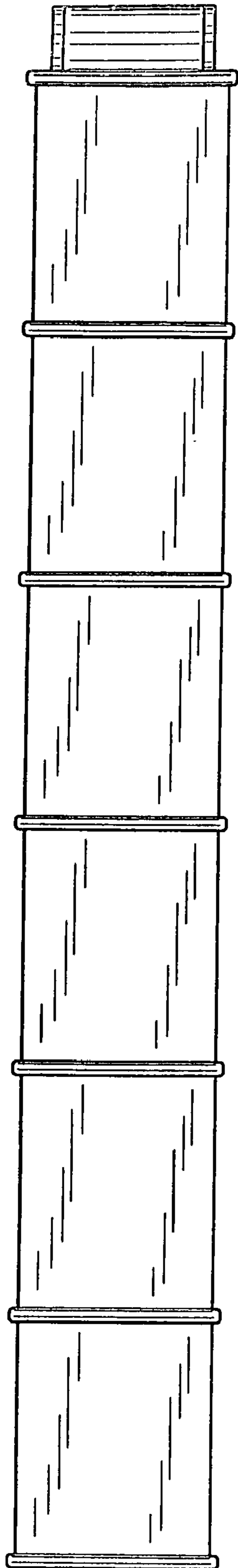

FIG. 11

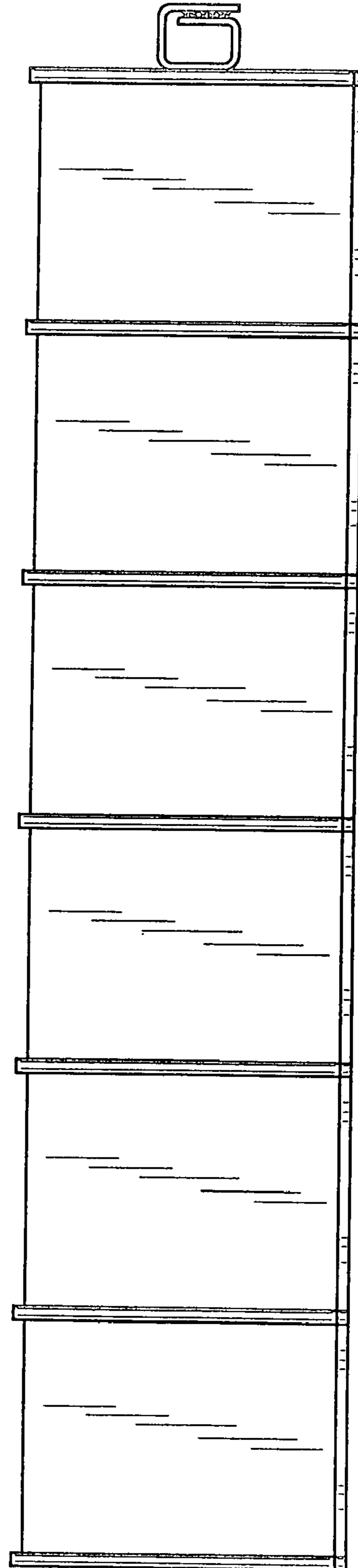

FIG. 12

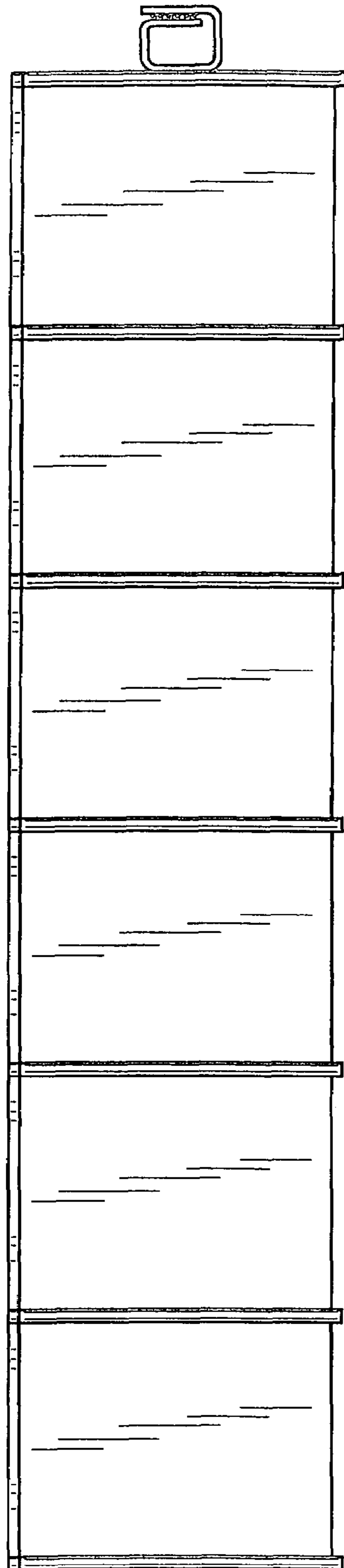

FIG. 13

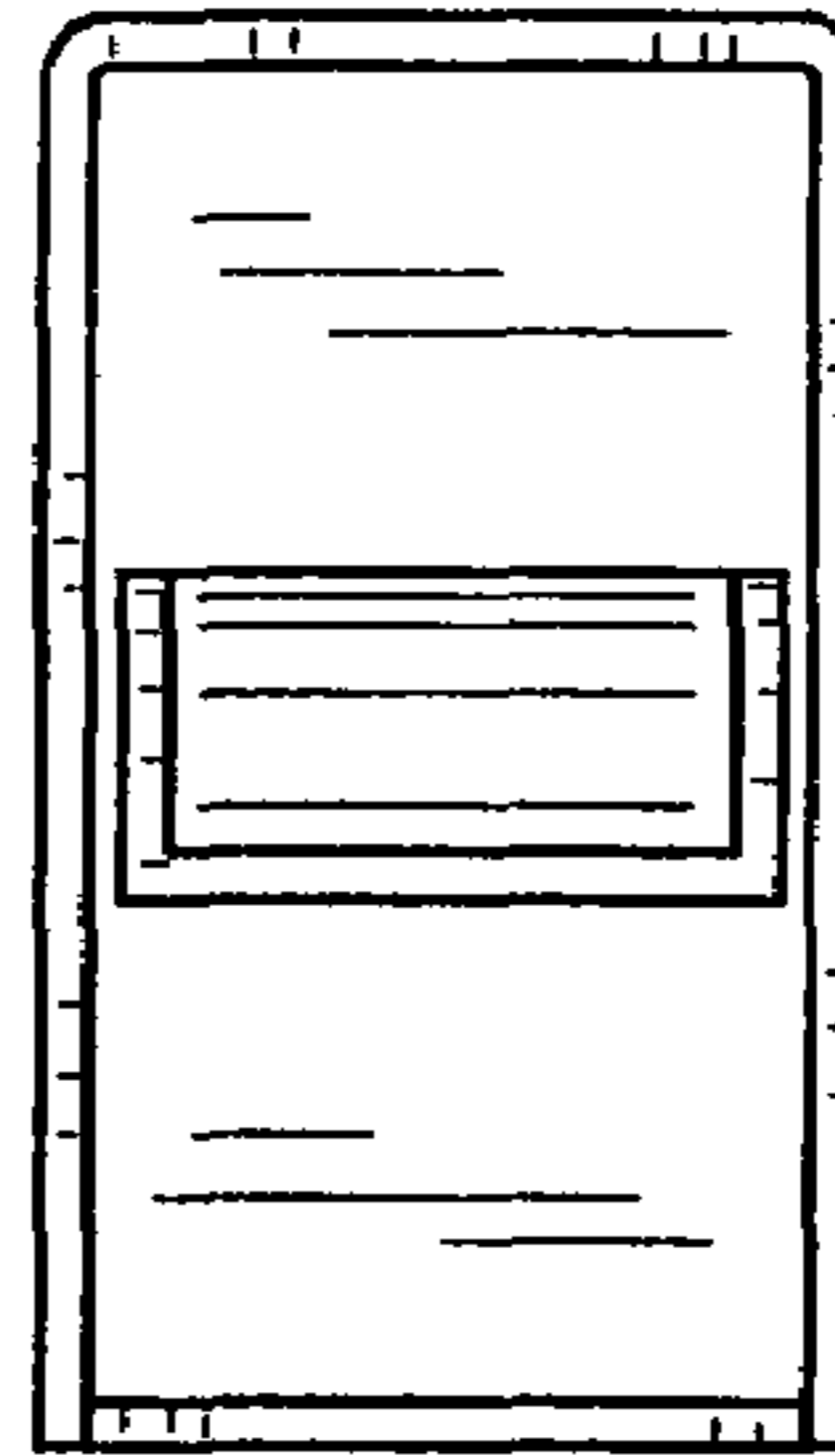

FIG. 14

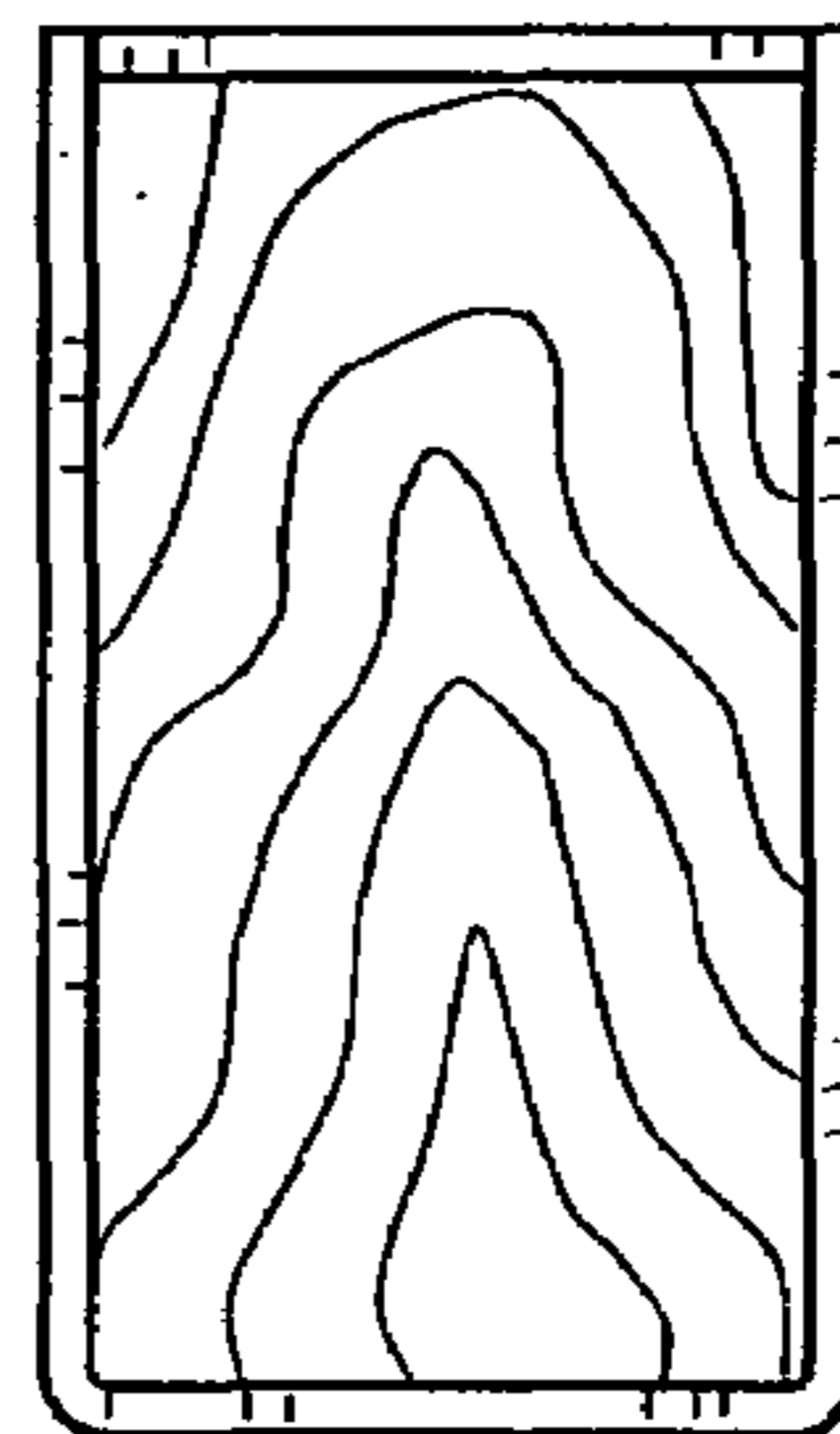

FIG. 15

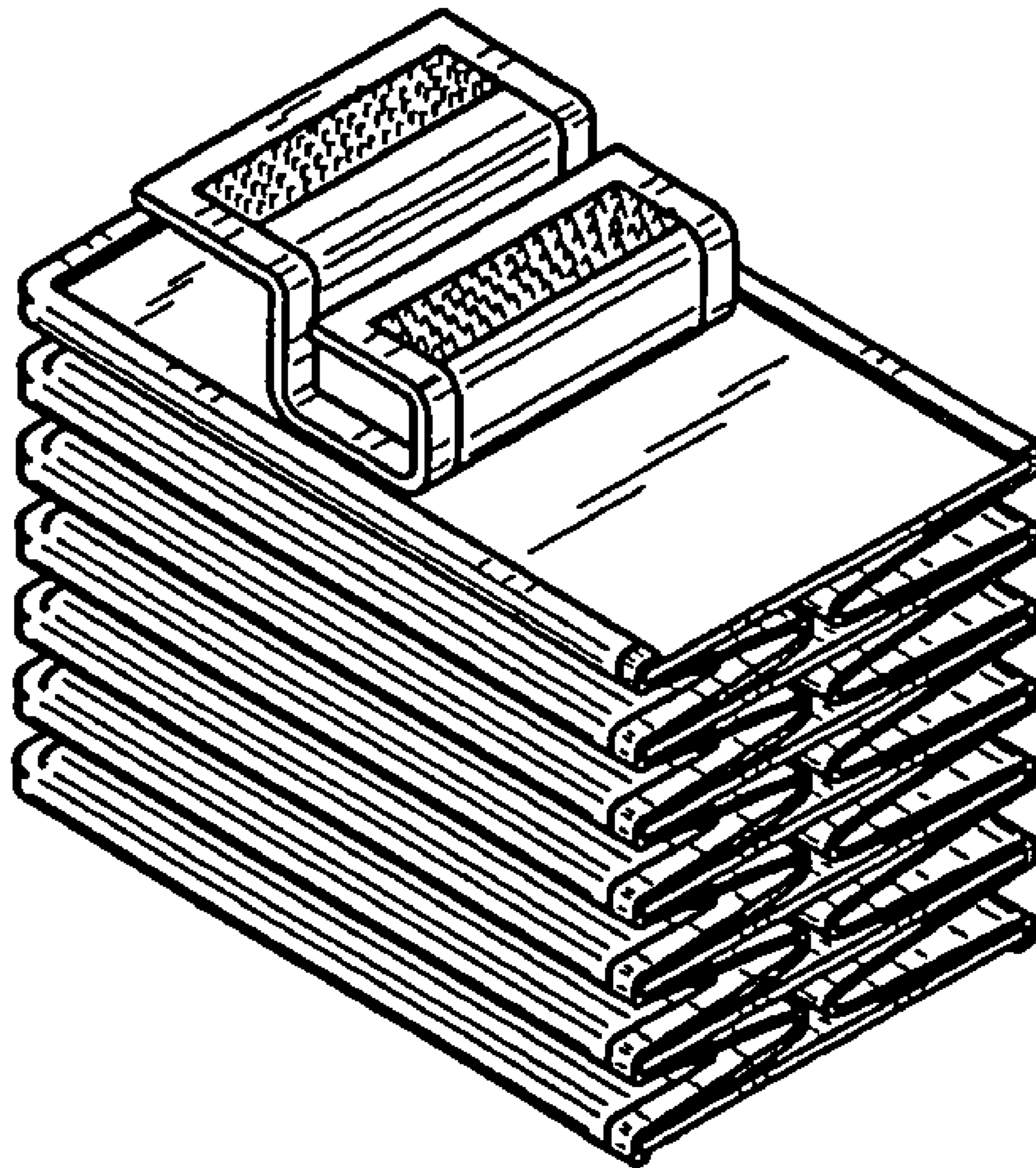

FIG. 16