



US00D569581S

(12) **United States Design Patent**
Stogner

(10) **Patent No.:** **US D569,581 S**

(45) **Date of Patent:** **** May 27, 2008**

(54) **SCARF CUFF JEANS AND SHORTS**

(57) **CLAIM**

(75) **Inventor:** **Roy Scott Stogner**, 1290 Oakdale Rd.,
Canton, GA (US) 30114

I claim the ornamental design for scarf cuff jeans and shorts,
as shown and described.

(73) **Assignee:** **Roy Scott Stogner**, Canton, GA (US)

(**) **Term:** **14 Years**

DESCRIPTION

(21) **Appl. No.:** **29/282,639**

FIG. 1 is a perspective view of shorts with scarf cuffs,
showing my new design;

(22) **Filed:** **Jul. 25, 2007**

FIG. 2 is a front elevational view of the shorts of the
invention;

(51) **LOC (8) Cl.** **02-02**

FIG. 3 is a rear elevational view of the shorts of the
invention;

(52) **U.S. Cl.** **D2/742; D2/731**

FIG. 4 is a left-side elevational view of the shorts of the
invention;

(58) **Field of Classification Search** D2/731,
D2/734, 738, 742-748, 857; 2/22, 23, 79,
2/80, 227, 228, 235, 237, 238, 247, 919
See application file for complete search history.

FIG. 5 is a right-side elevational view of the shorts of the
invention;

(56) **References Cited**

U.S. PATENT DOCUMENTS

FIG. 6 is a top plan view of the shorts of the invention;

FIG. 7 is a bottom plan view of the shorts of the invention;

D183,710	S	*	10/1958	Blaivas	D3/238
3,221,689	A	*	12/1965	James	112/475.01
3,234,564	A	*	2/1966	Chujfi	2/227
D267,369	S	*	12/1982	Blanchard	D3/238
D339,220	S	*	9/1993	Buziol	D2/742
5,308,275	A	*	5/1994	Kornbleuth	446/28
D352,814	S	*	11/1994	Sherman	D2/734

FIG. 8 is a perspective view of jeans with scarf cuffs;

FIG. 9 is a front elevational view of the jeans of the
invention;

FIG. 10 is a rear elevational view of the jeans of the
invention;

(Continued)

FOREIGN PATENT DOCUMENTS

FIG. 11 is a right-side elevational view of the jeans of the
invention;

FIG. 12 is a left-side elevational view of the jeans of the
invention;

GB 2082043 A * 3/1982

OTHER PUBLICATIONS

FIG. 13 is a top plan view of the jeans of the invention; and,
FIG. 14 is a bottom plan view of the jeans of the invention.

Tactics.com. <http://www.tactics.com/volcom/feline-shorts>. Date
unknown: Viewed Nov. 2007. Volcom Feline Shorts: center of
page.*

The broken lines showing a pattern on the scarf in the figures
are included for the purpose of illustrating the invention in
use, and form no part of the claimed design. The remaining
broken lines showing stitching in the figures are included for
the purpose of illustrating threaded stitches, and are consid-
ered part of the claimed design.

SpoiledRottenKids.com. [http://www.spoiledrottenkids.com/
Young_Womens_Denim_Pants.asp](http://www.spoiledrottenkids.com/Young_Womens_Denim_Pants.asp). Date unknown: Viewed Nov.
2007. Roll Cuff Jean Short: center of page.*

Primary Examiner—Ian Simmons
Assistant Examiner—Rashida Johnson

1 Claim, 8 Drawing Sheets

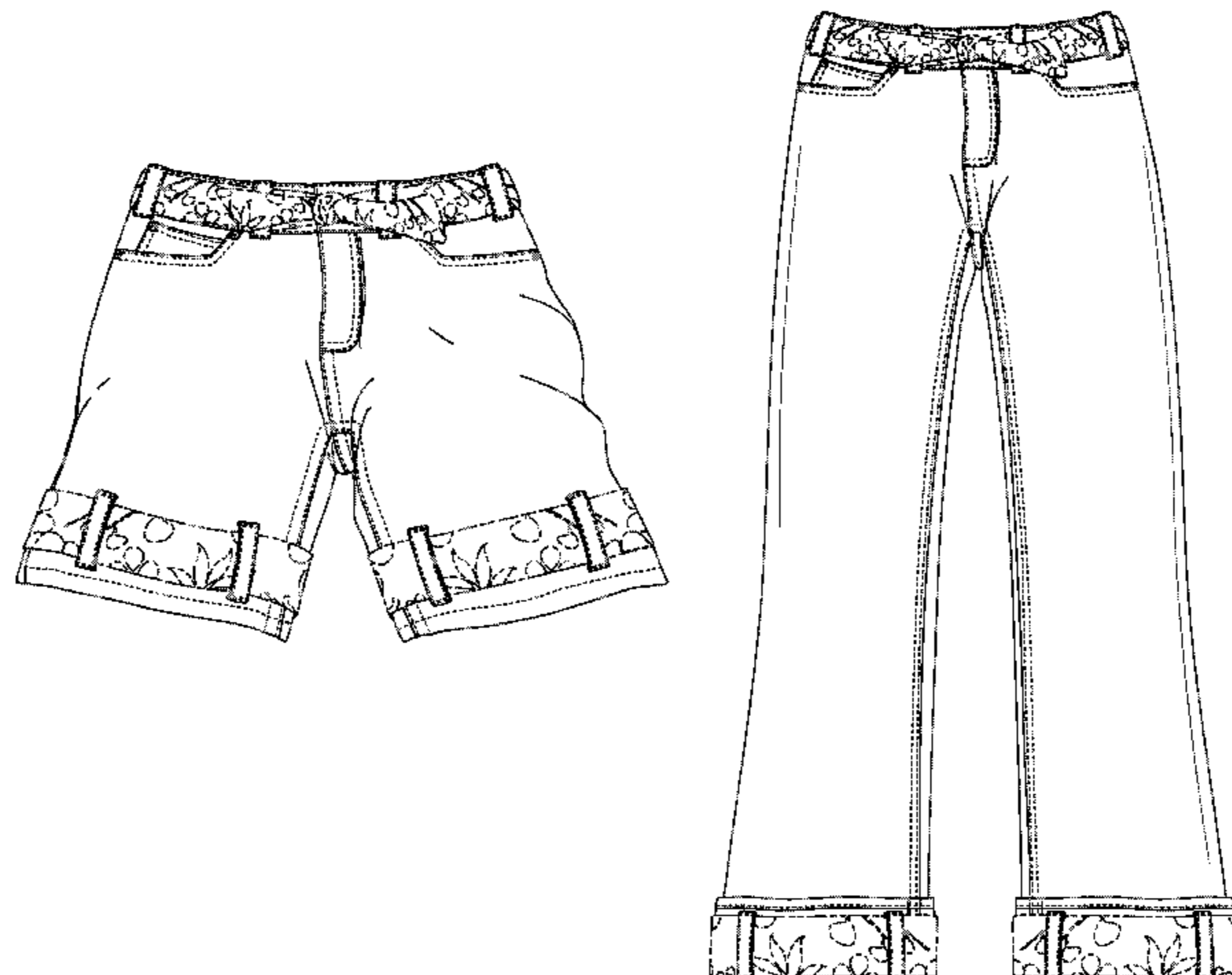

US D569,581 S

Page 2

U.S. PATENT DOCUMENTS

5,918,319 A *	7/1999	Baxter	2/455	D505,753 S *	5/2005	Qvortrup	D29/100
6,311,333 B1 *	11/2001	Batra	2/237	D535,473 S *	1/2007	Hill	D3/238
6,526,597 B1 *	3/2003	Shepard	2/255	2004/0205879 A1 *	10/2004	Leba	2/247

* cited by examiner

FIG. 1

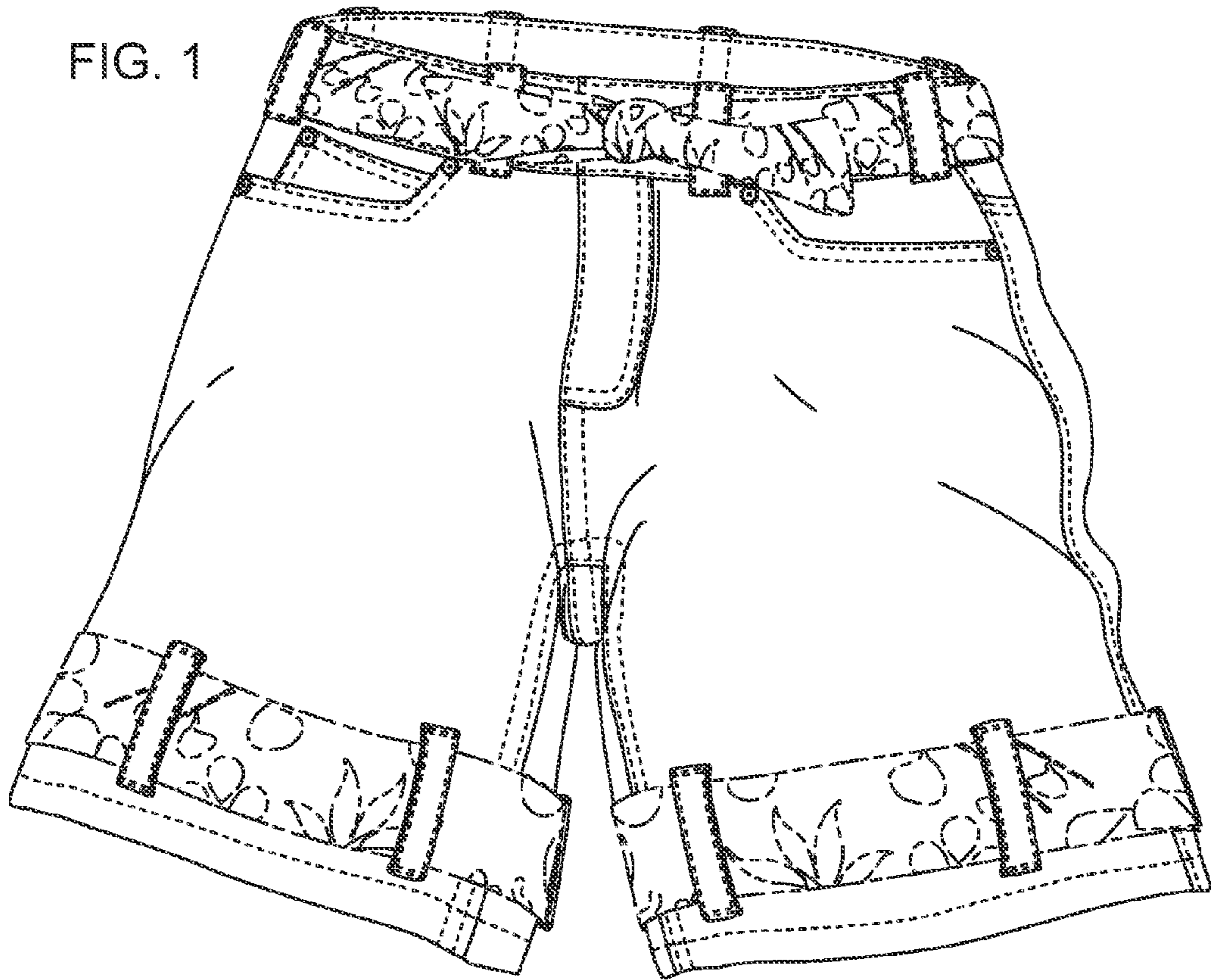

FIG. 2



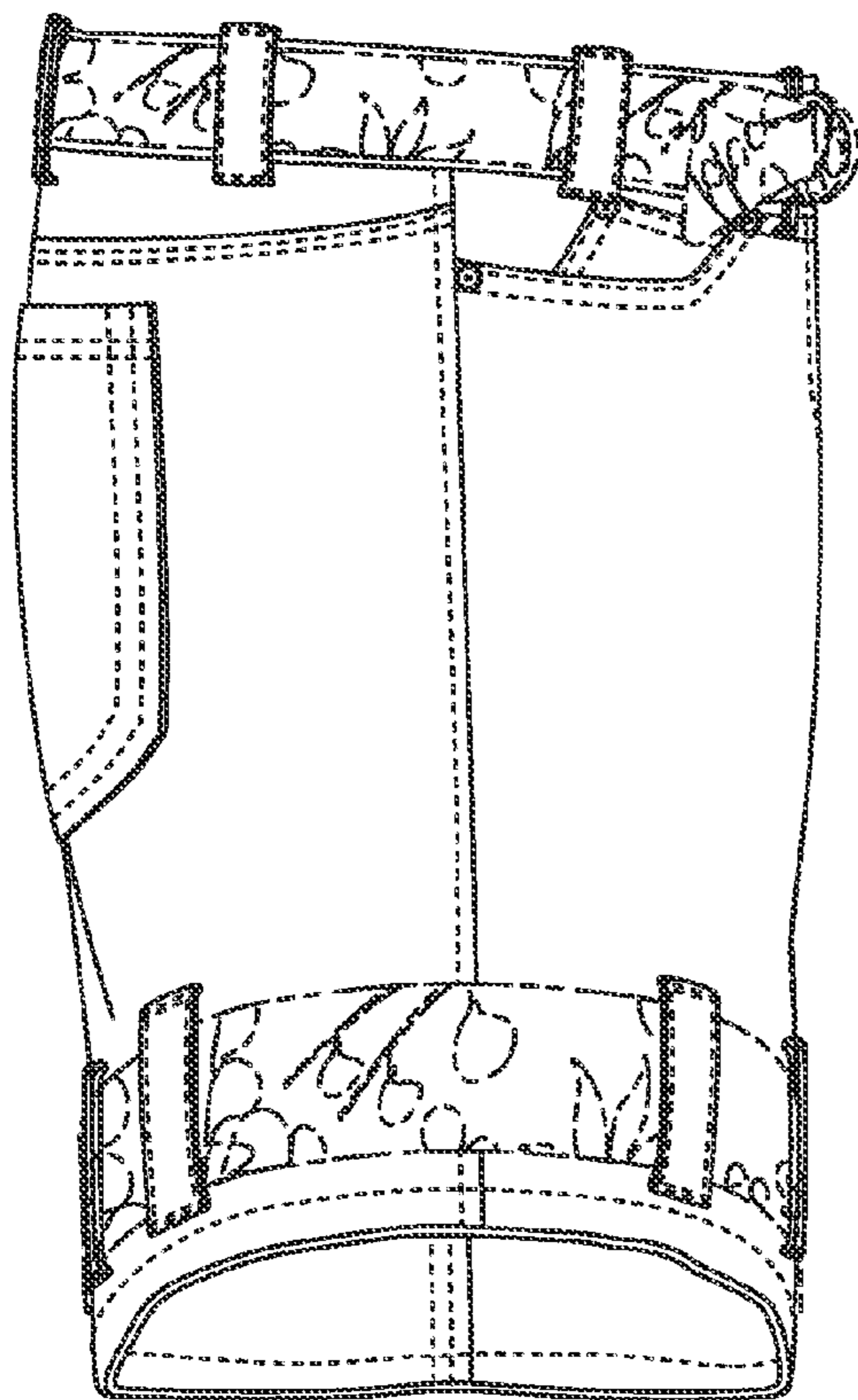
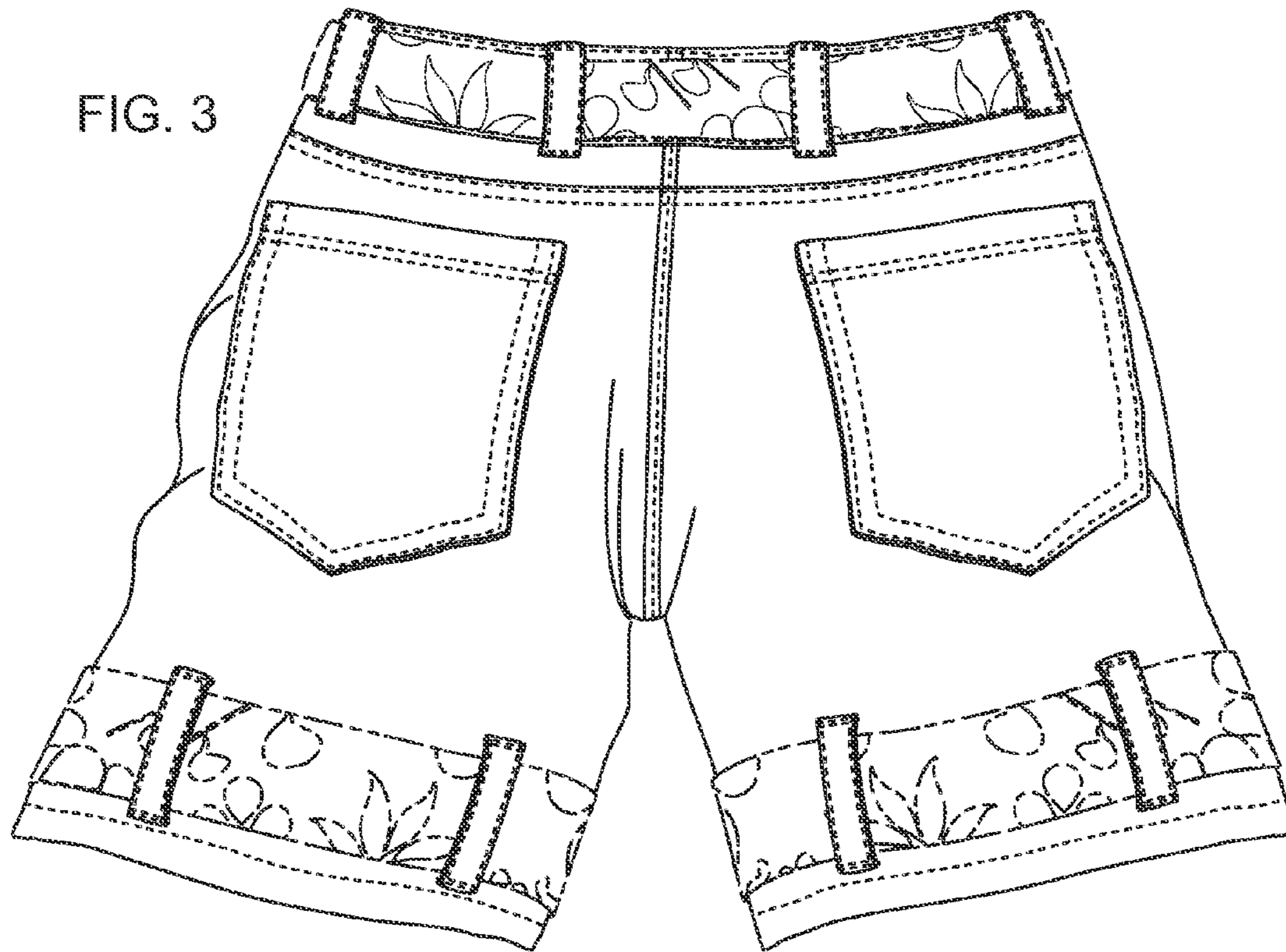

FIG. 4

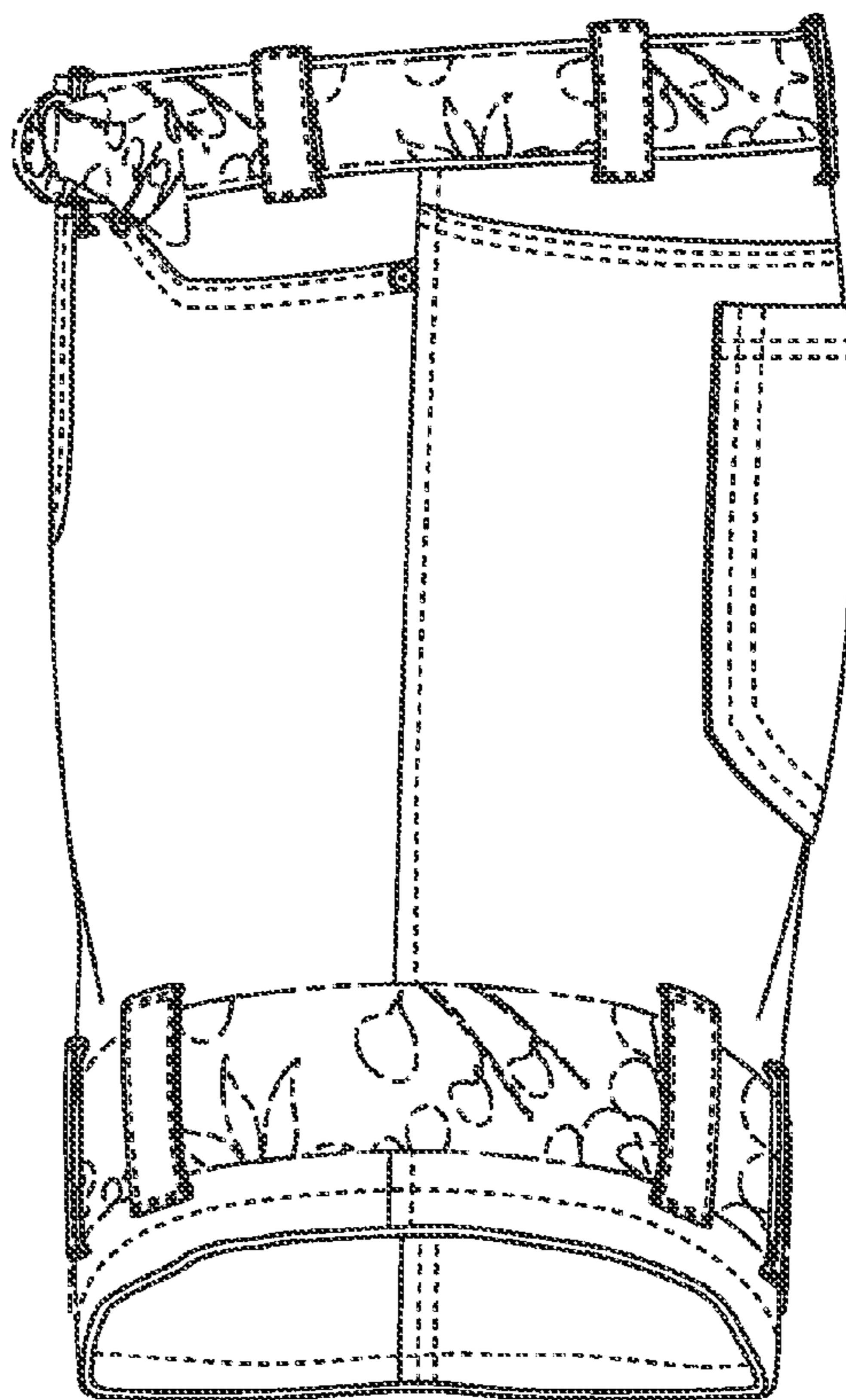

FIG. 5

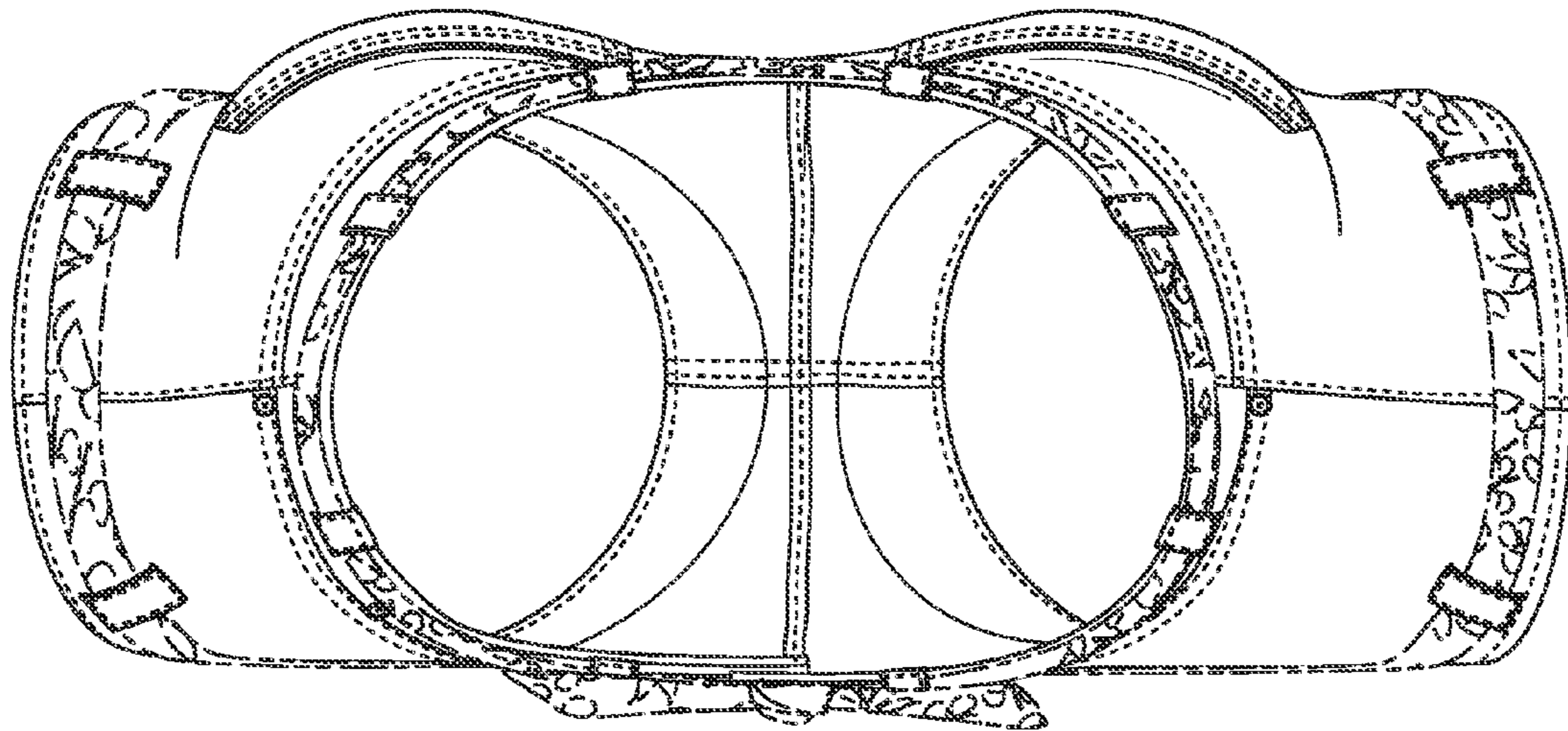

FIG. 6

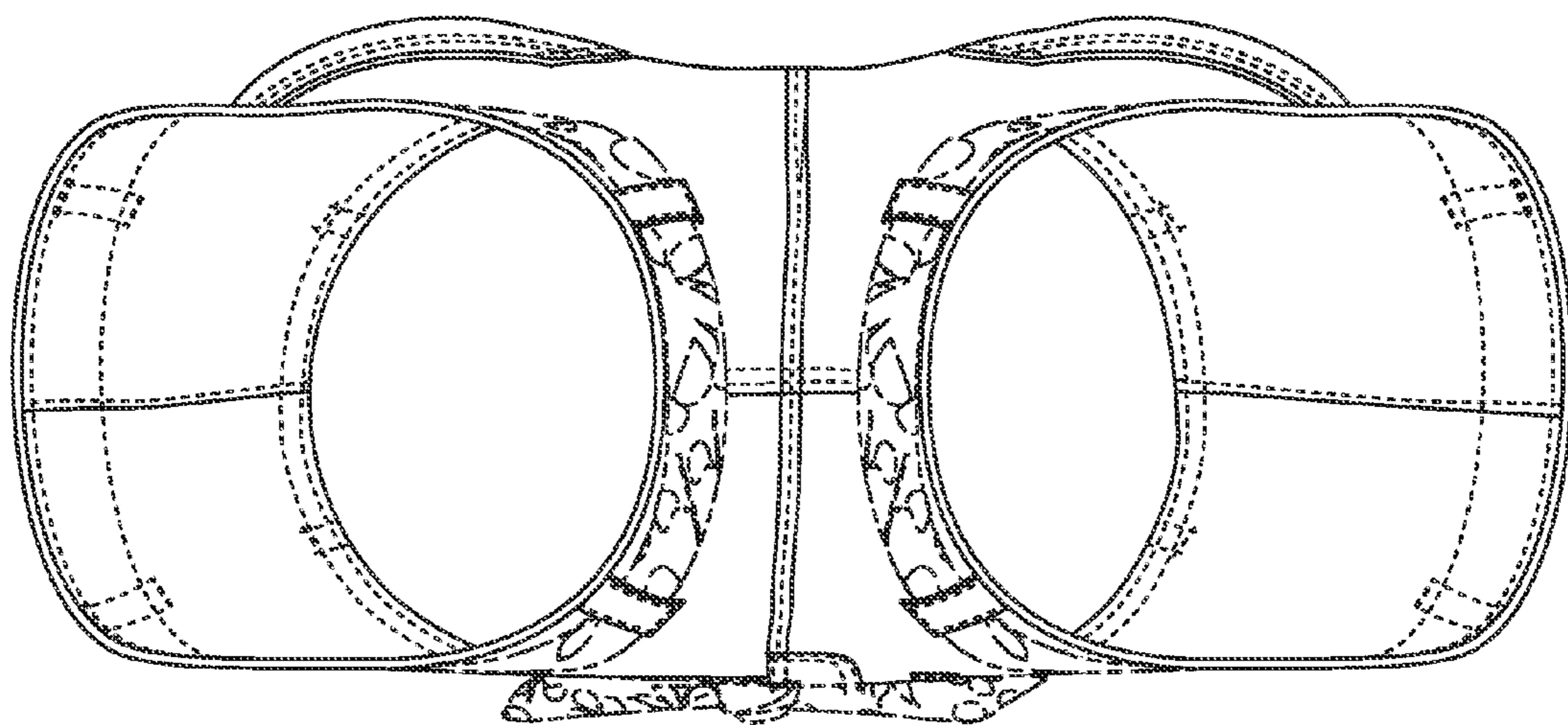

FIG. 7

FIG. 8

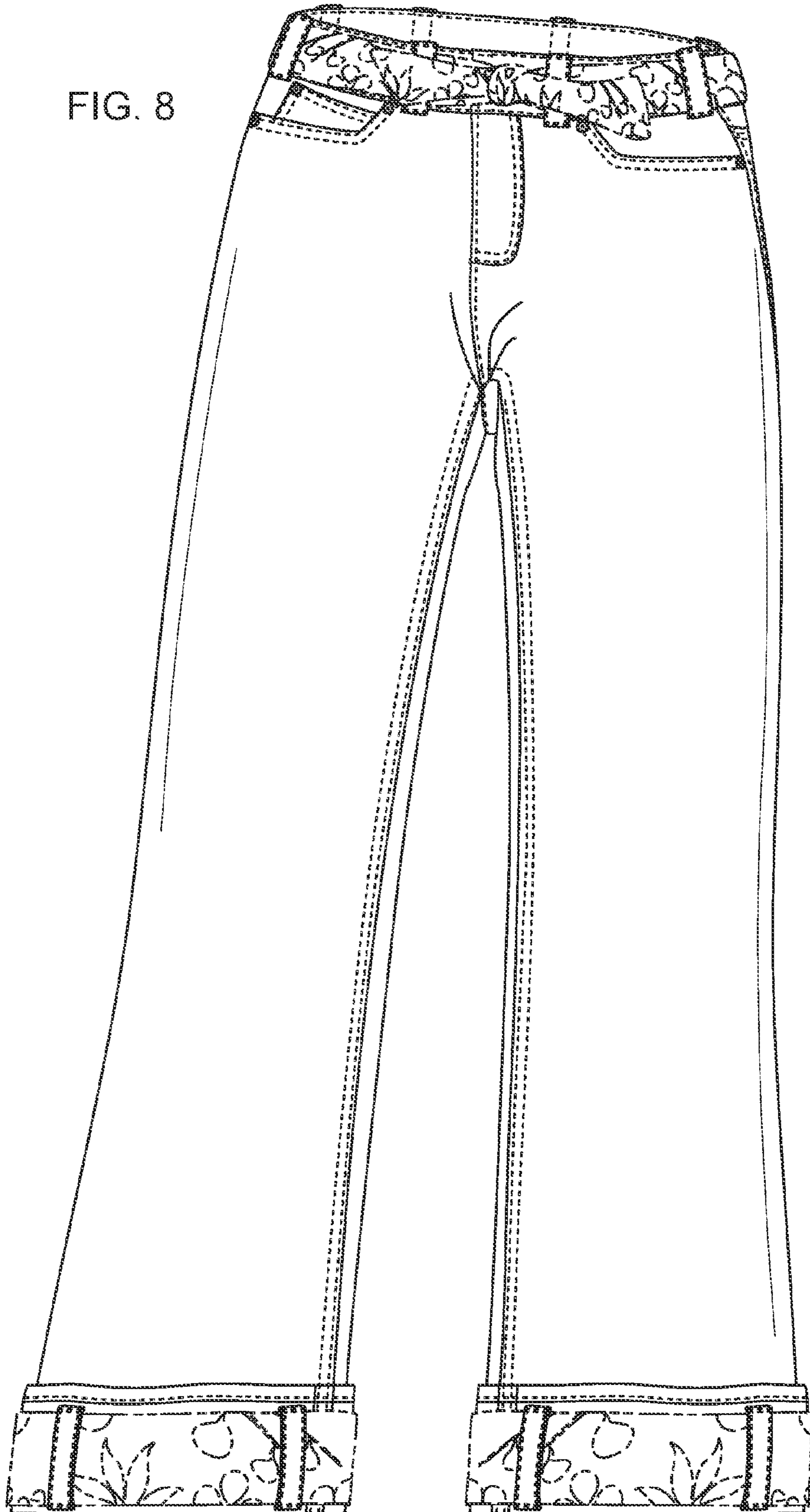

FIG. 9

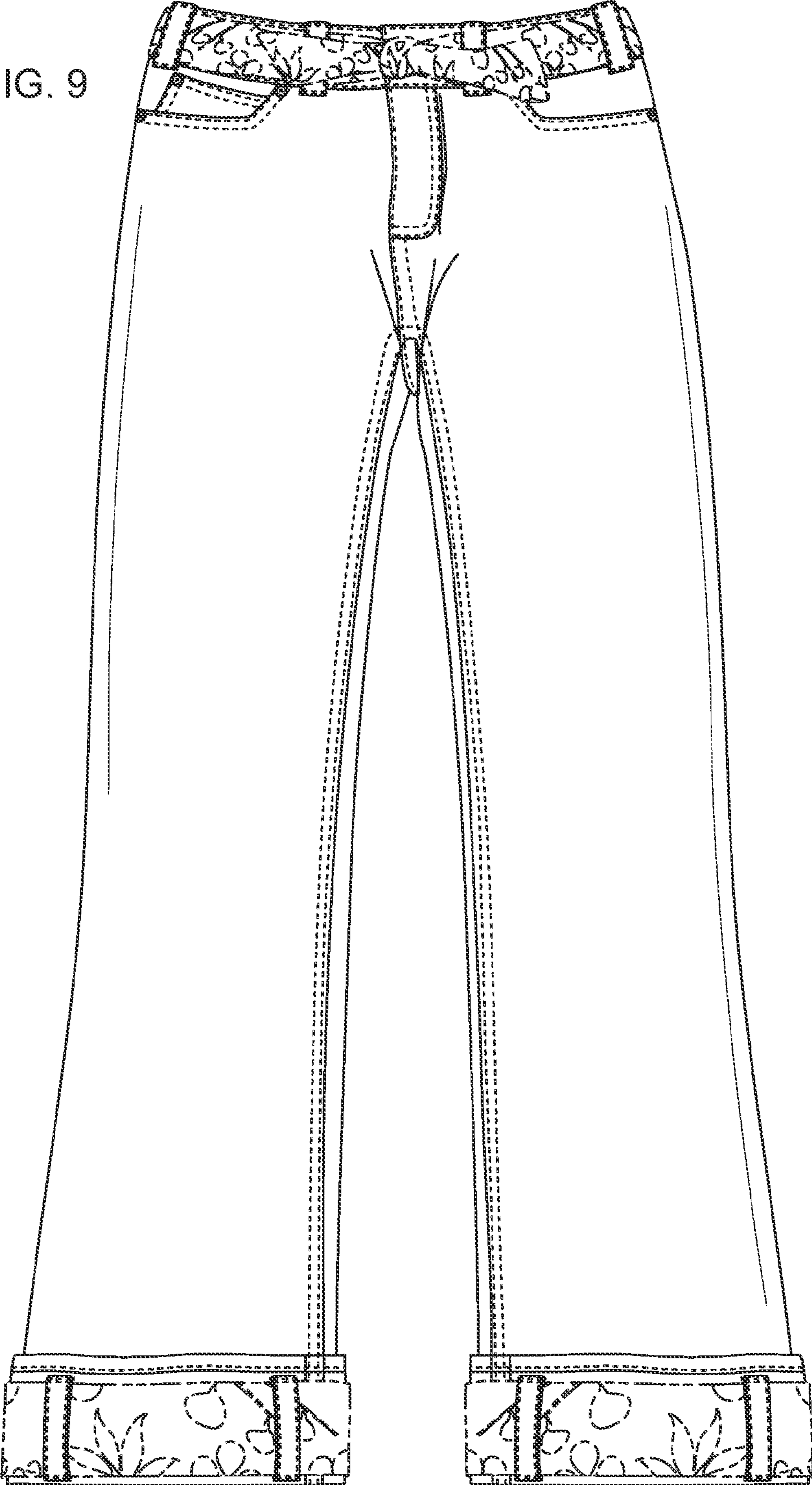
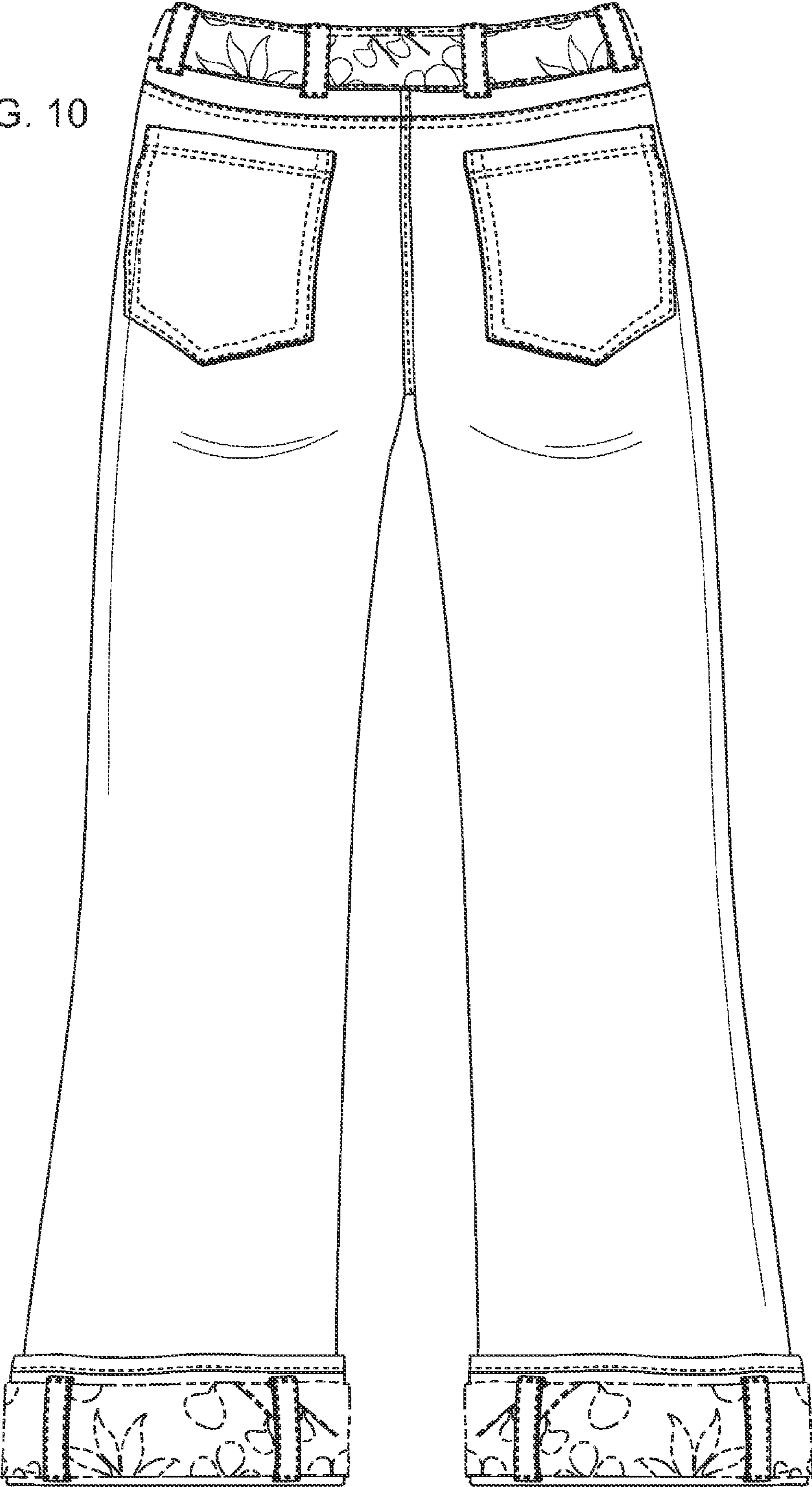

FIG. 10



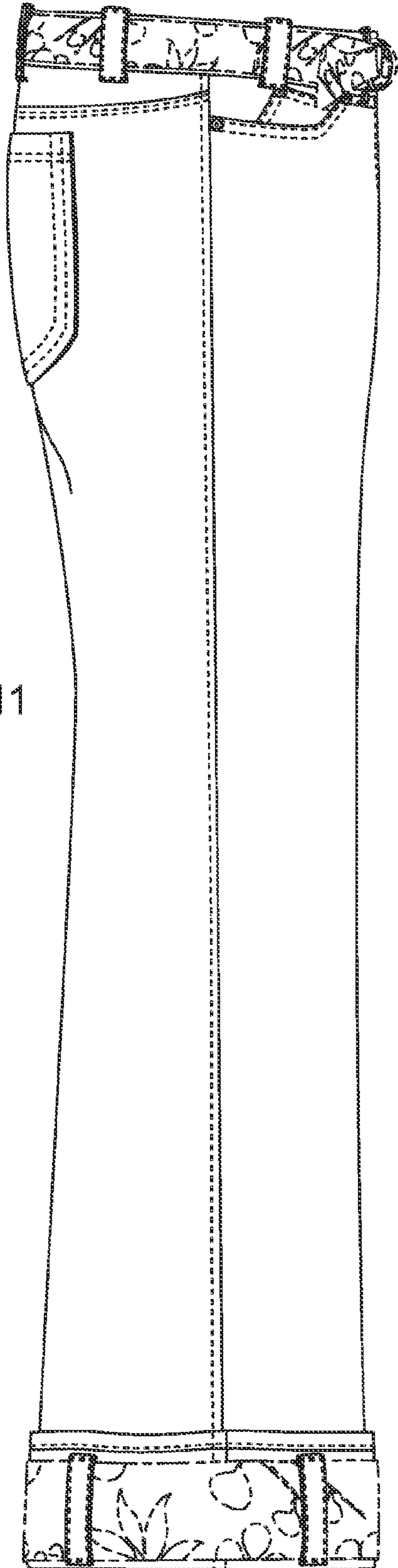

FIG. 11

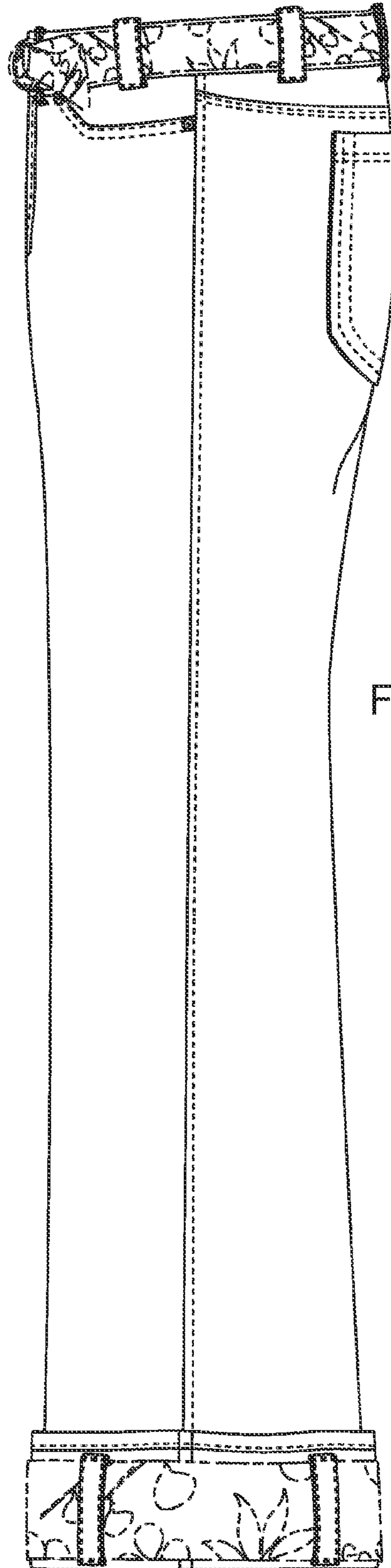

FIG. 12

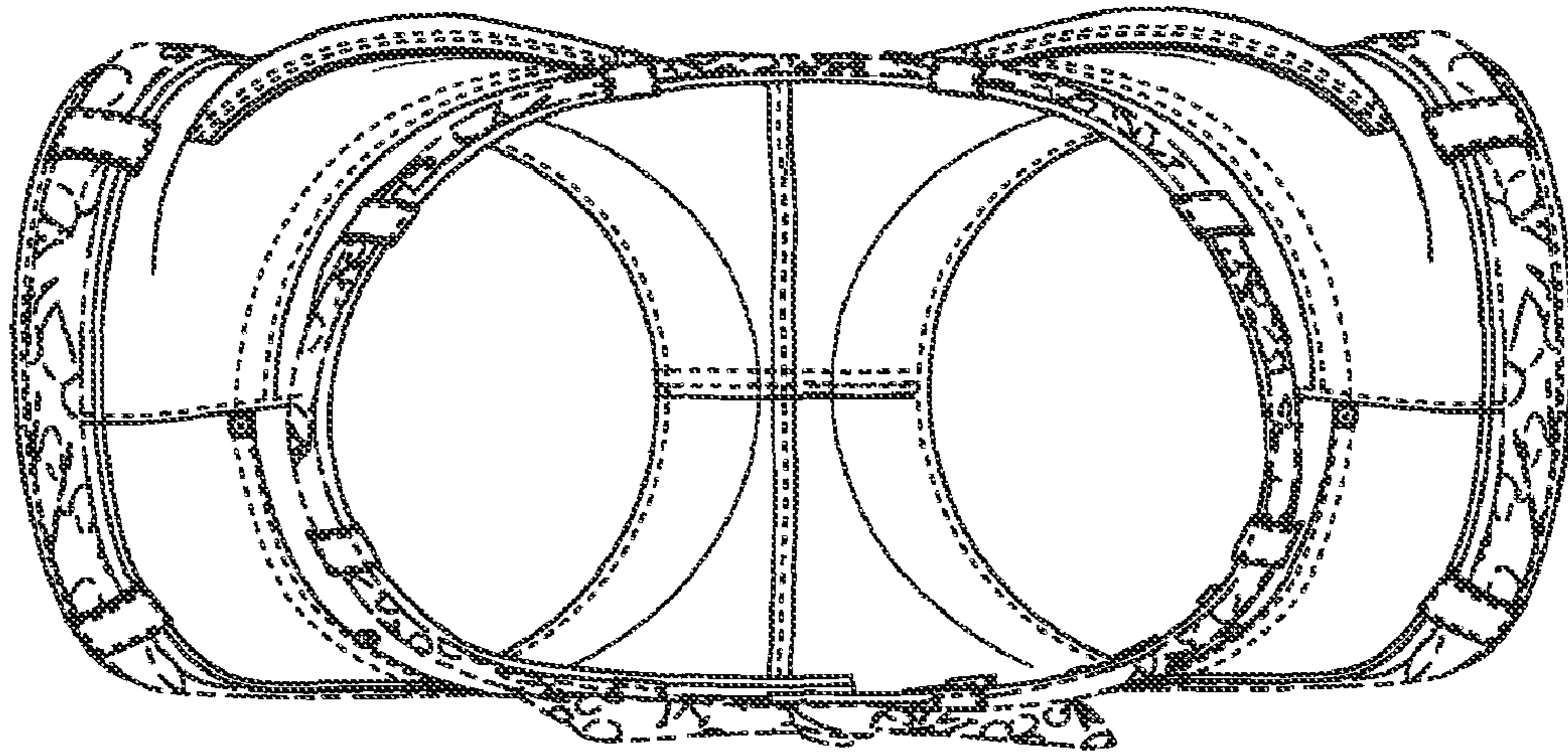

FIG. 13

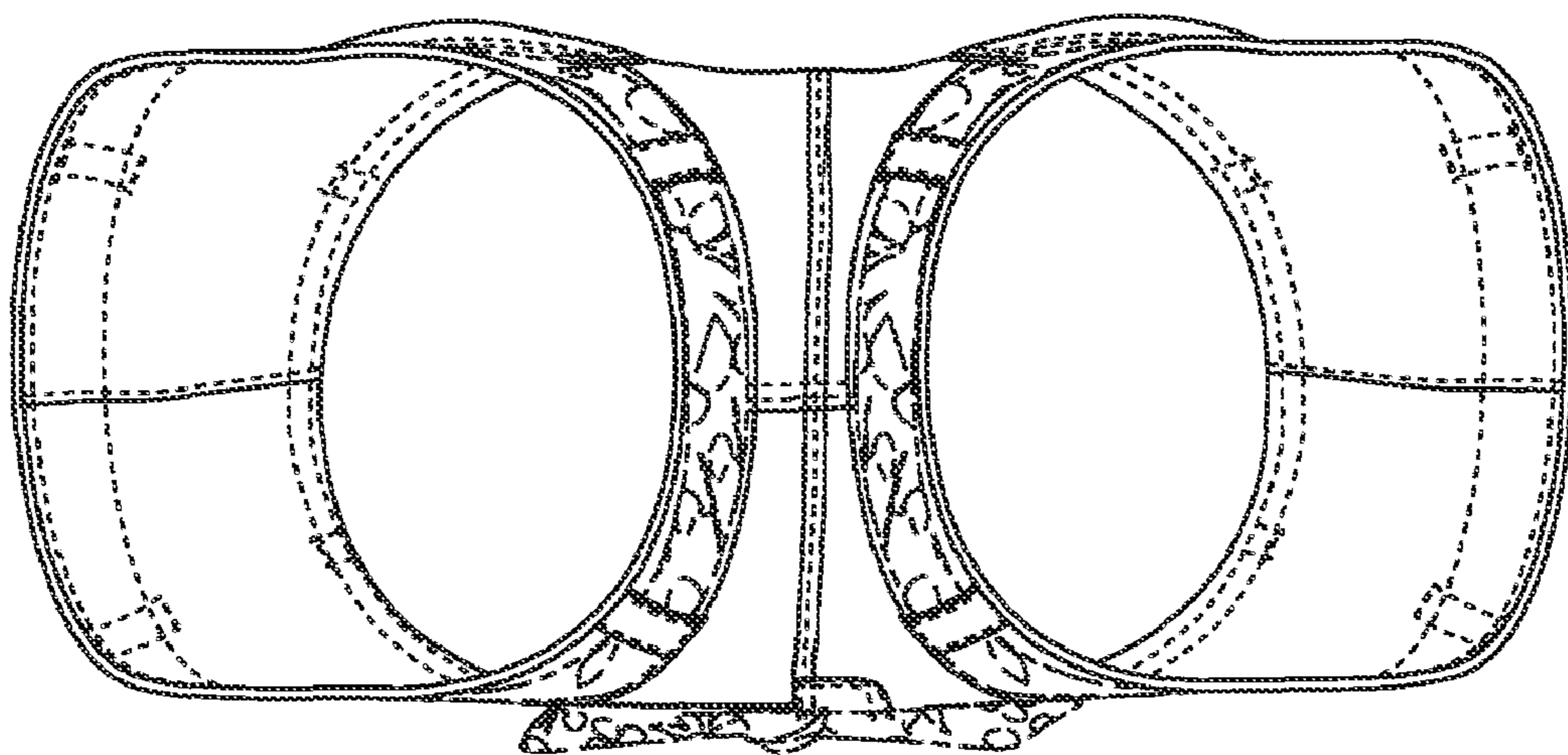

FIG. 14