

US00D569540S

(12) **United States Design Patent**  
**Bourgeois et al.**

(10) **Patent No.:** **US D569,540 S**

(45) **Date of Patent:** **\*\* May 20, 2008**

(54) **LIGHTING FIXTURE**

(75) Inventors: **Luc Bourgeois**, Lachenaie (CA);  
**Francois Couillard**, Blainville (CA);  
**Patrick Martineau**, Ile-Perrot (CA);  
**Johnathan Cote**, Montreal (CA); **Radu**  
**Cornel Rapeanu**, Mont-Royal (CA)

(73) Assignee: **Thomas & Betts International, Inc.**,  
Wilmington, DE (US)

(\*\*) Term: **14 Years**

(21) Appl. No.: **29/271,939**

(22) Filed: **Jan. 30, 2007**

(51) **LOC (8) Cl.** ..... **26-03**

(52) **U.S. Cl.** ..... **D26/85; D26/71**

(58) **Field of Classification Search** ..... D26/71,  
D26/72, 85, 88, 89, 121, 122; 362/147, 348-350,  
362/367, 432, 806, 572

See application file for complete search history.

(56) **References Cited**

**U.S. PATENT DOCUMENTS**

D187,082 S *	1/1960	Parker, Jr.	.....	D26/85
D189,054 S *	10/1960	Jaffe, Jr.	.....	D26/85
D199,327 S *	10/1964	Guth, Jr.	.....	D26/72
D255,106 S *	5/1980	Bodenrader et al.	.....	D26/85
D380,572 S *	7/1997	Bodell et al.	.....	D26/85
D394,124 S *	5/1998	Mackert et al.	.....	D26/85

D459,519 S *	6/2002	Russello et al.	.....	D26/85
D468,046 S	12/2002	Bernard et al.	.....	D26/85
D503,822 S *	4/2005	Monroe et al.	.....	D26/85
7,150,542 B1 *	12/2006	Russello et al.	.....	362/432
D552,292 S *	10/2007	Martineau	.....	D26/85

**OTHER PUBLICATIONS**

AFFINITY, Architectural Emergency Lighting (Lithonia Lighting).  
SURE-LITES, Architectural Emergency Light (Cooper Lighting).  
LITESCAP (Dual-Lite).

\* cited by examiner

*Primary Examiner*—Clare E Heflin

(74) *Attorney, Agent, or Firm*—Michael L. Hoelter

(57) **CLAIM**

The ornamental design for a lighting fixture, as shown and described.

**DESCRIPTION**

FIG. 1 is a top isometric view of the lighting fixture of the present invention;

FIG. 2 is a bottom isometric view thereof;

FIG. 3 is a top plan view thereof;

FIG. 4 is a front elevation view thereof;

FIG. 5 is a bottom plan view thereof;

FIG. 6 is a rear elevation view thereof; and,

FIG. 7 is a side elevation view thereof.

**1 Claim, 3 Drawing Sheets**

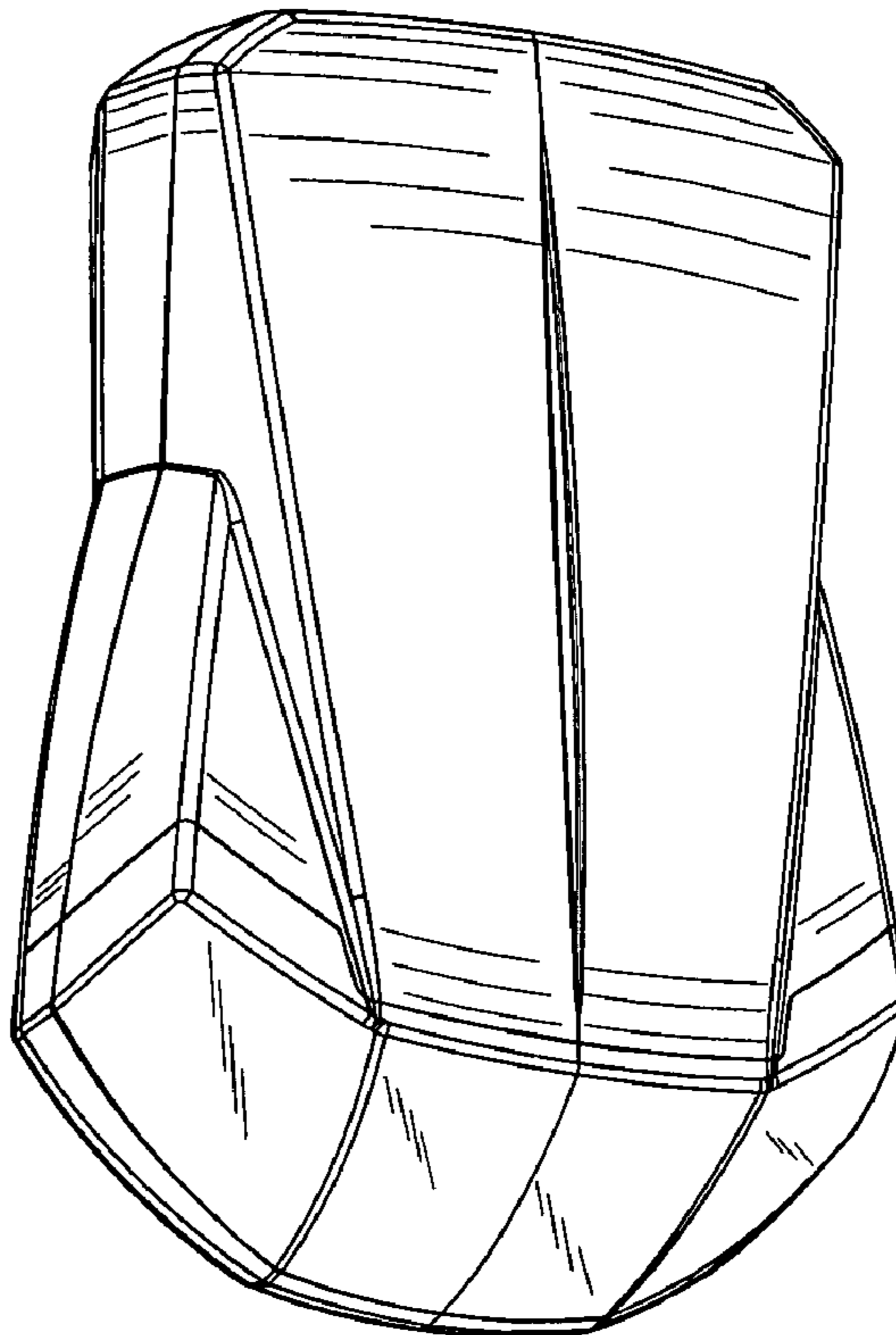
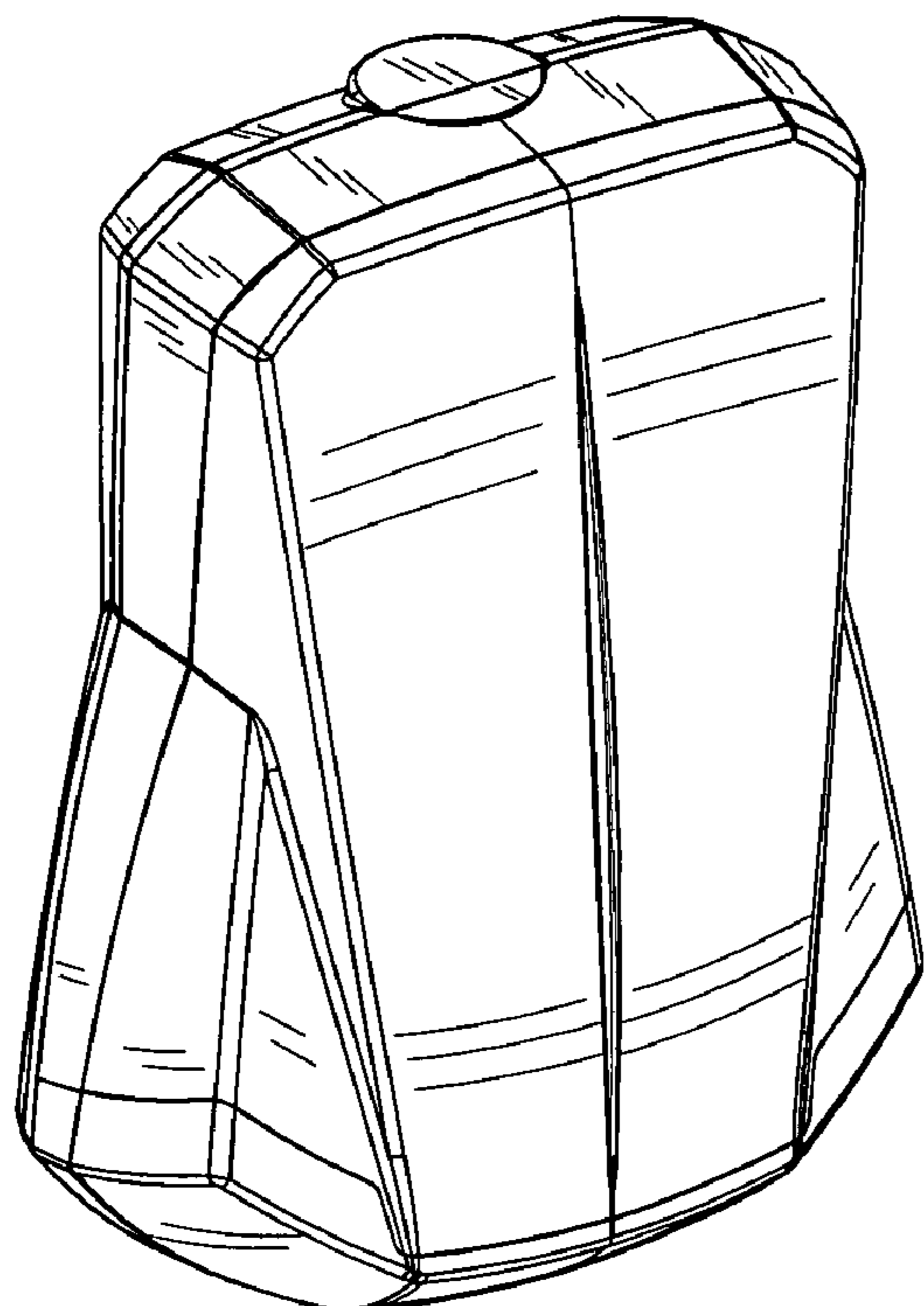

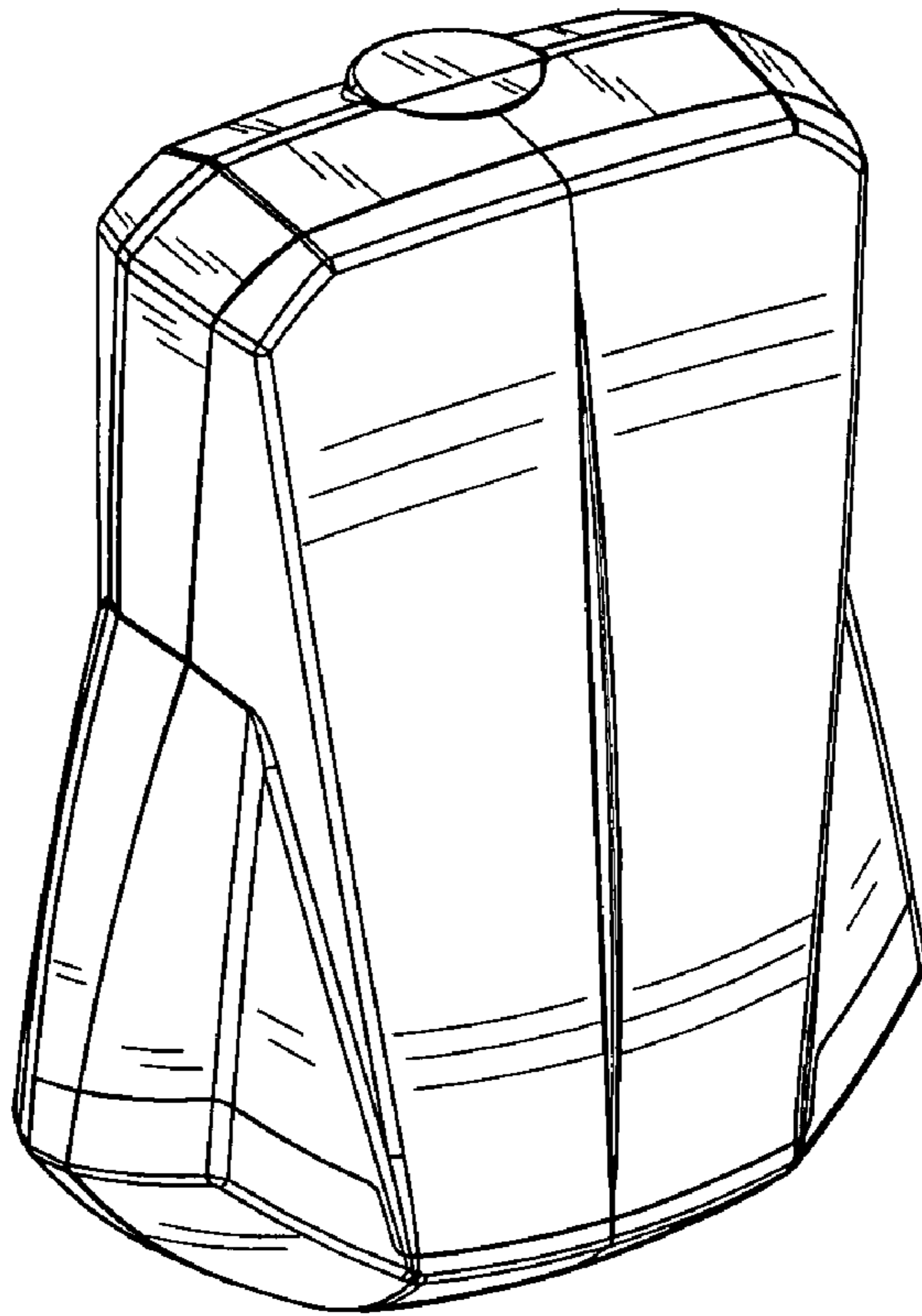

FIG. 1

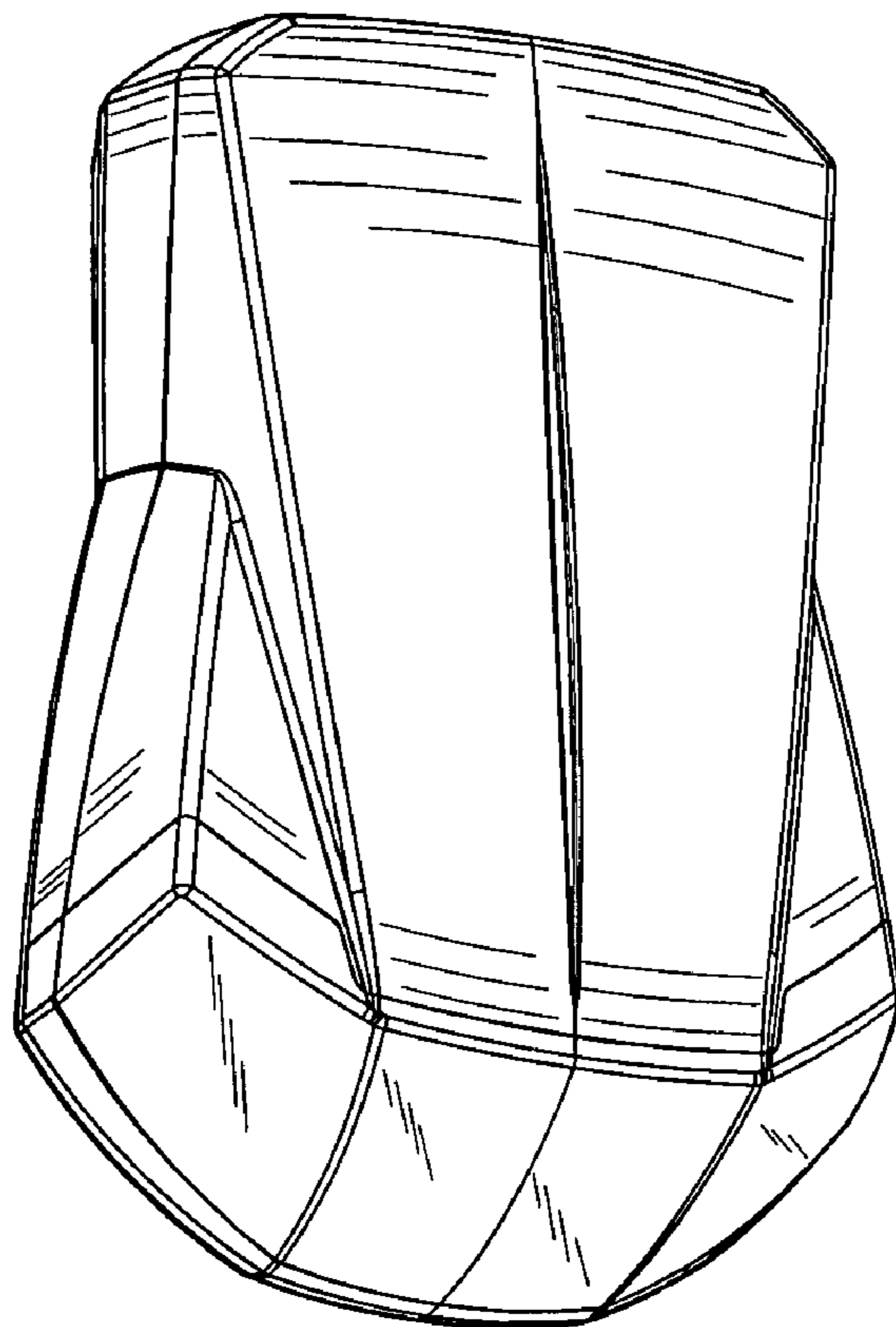

FIG. 2

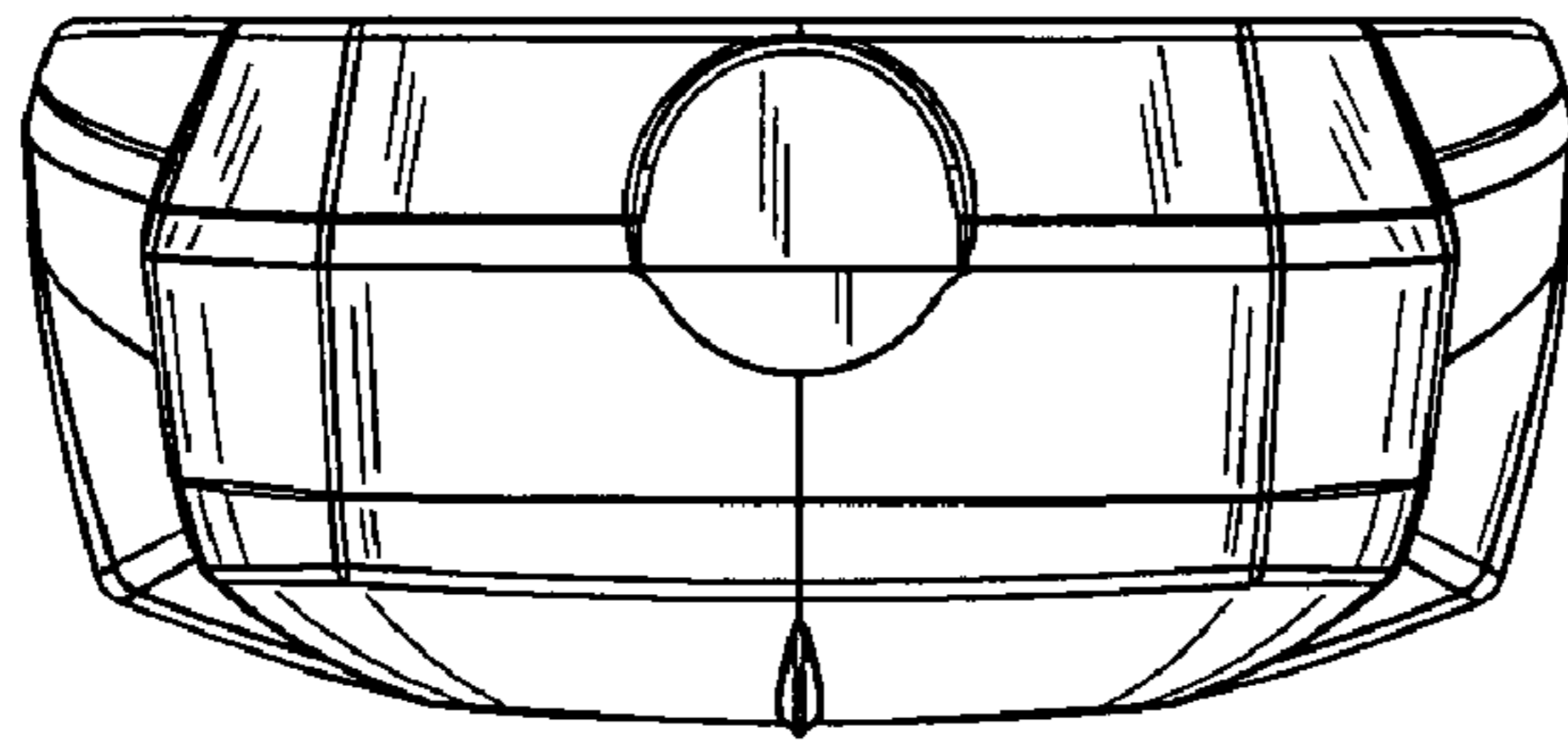

FIG. 3

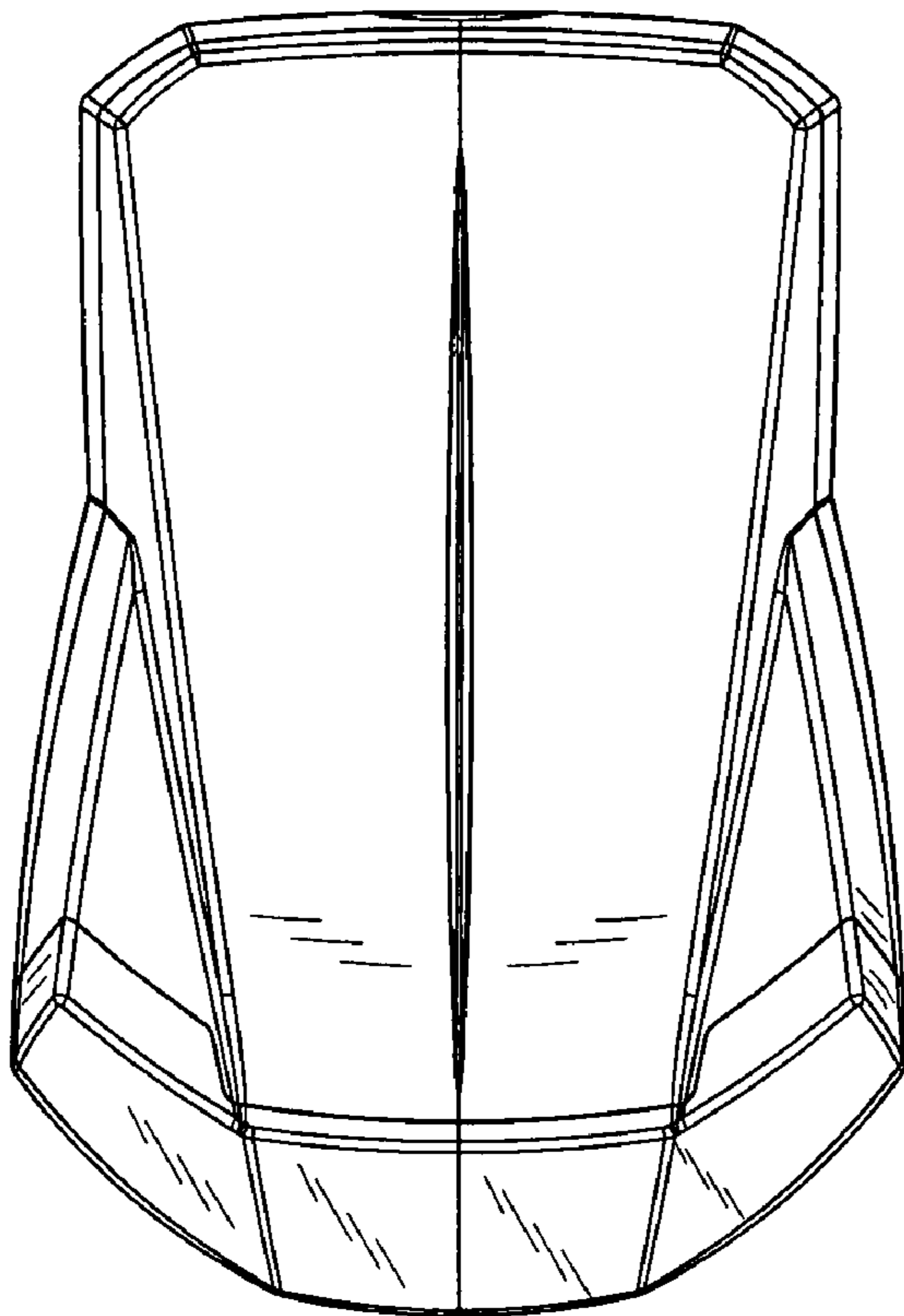

FIG. 4

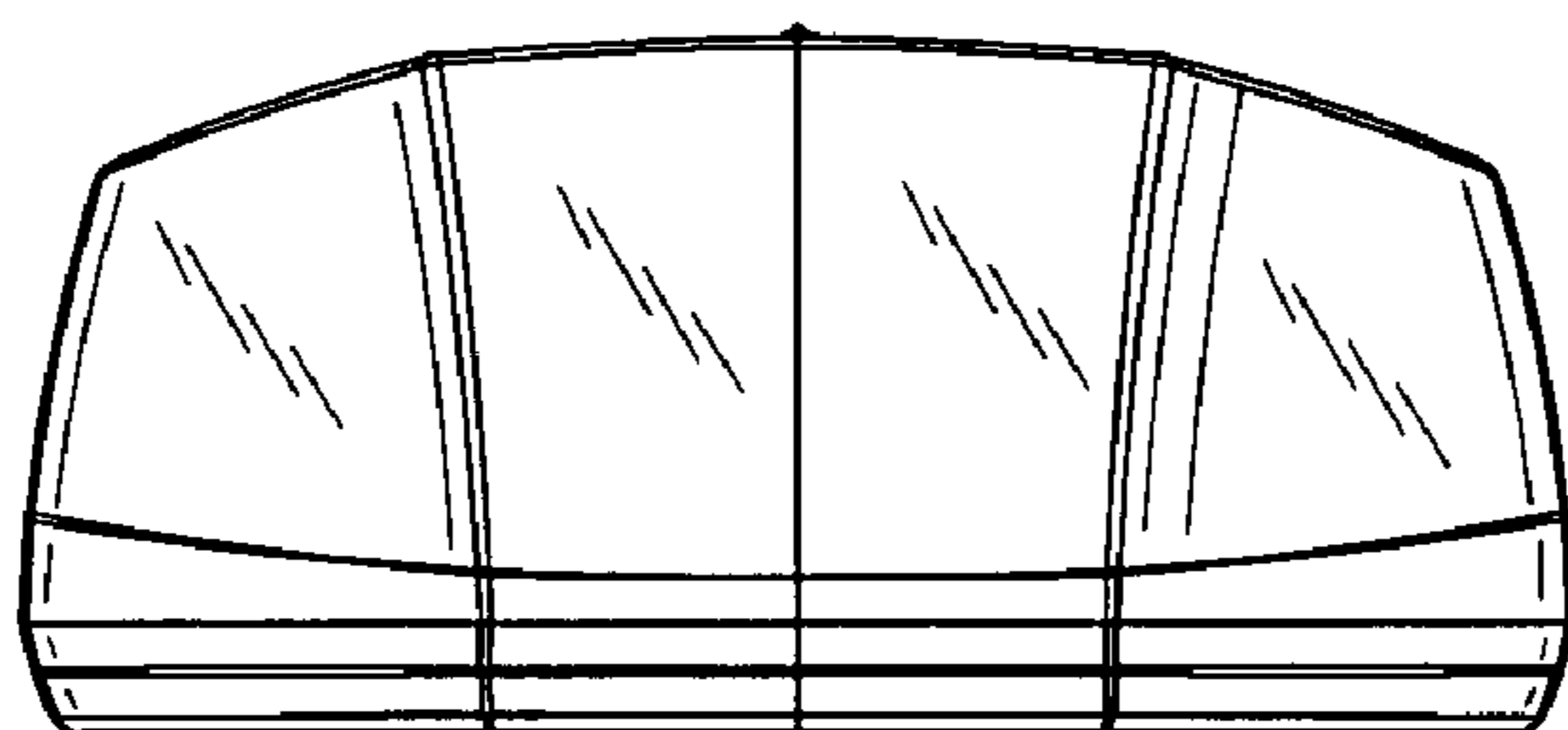

FIG. 5

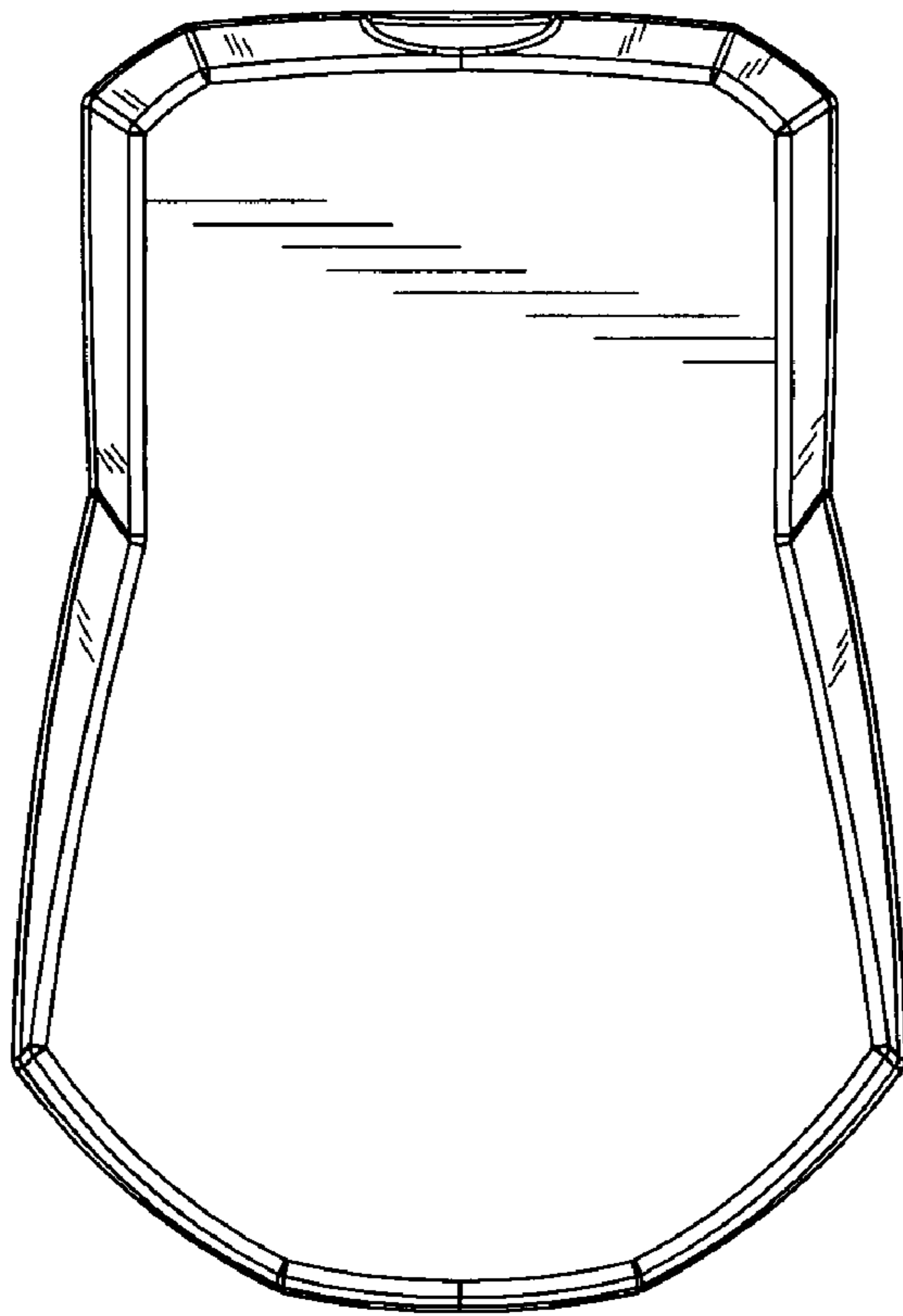

FIG. 6



FIG. 7