



US00D569437S

(12) **United States Design Patent**  
**Shimizu**

(10) **Patent No.:** **US D569,437 S**

(45) **Date of Patent:** **\*\* May 20, 2008**

(54) **CAP FOR WRITING INSTRUMENT**

(75) Inventor: **Kazuhisa Shimizu**, Tokyo (JP)

(73) Assignee: **Pentel Kabushiki Kaisha** (JP)

(\*\*) Term: **14 Years**

(21) Appl. No.: **29/271,173**

(22) Filed: **Jan. 11, 2007**

(30) **Foreign Application Priority Data**

Jul. 19, 2006 (JP) ..... 2006-018910

(51) **LOC (8) Cl.** ..... **19-06**

(52) **U.S. Cl.** ..... **D19/57**

(58) **Field of Classification Search** ..... D19/35,  
D19/36, 41-51, 53-57; 24/11 R, 11 F, 11 P;  
401/52, 99, 100, 104, 105, 106, 107, 108,  
401/109, 192, 195, 196

See application file for complete search history.

(56) **References Cited**

**U.S. PATENT DOCUMENTS**

2,479,414 A \* 8/1949 Sanbonmatsu ..... 401/107  
D451,545 S \* 12/2001 Tsuchikura ..... D19/36  
D472,575 S \* 4/2003 Middleton et al. .... D19/43  
D474,809 S \* 5/2003 Willat et al. .... D19/51  
D482,724 S \* 11/2003 Nishida ..... D19/43  
D483,066 S \* 12/2003 Takanashi ..... D19/43  
D505,158 S \* 5/2005 Tessier et al. .... D19/56

D507,299 S \* 7/2005 Qiu ..... D19/43  
D526,022 S \* 8/2006 Qiu ..... D19/51  
D526,683 S \* 8/2006 Qiu ..... D19/57  
D540,384 S \* 4/2007 Qiu ..... D19/43  
D553,189 S \* 10/2007 Qiu ..... D19/47  
D553,191 S \* 10/2007 Qiu ..... D19/50

**FOREIGN PATENT DOCUMENTS**

WO DM/052905 \* 8/2000  
WO DM/069377 \* 10/2007

\* cited by examiner

*Primary Examiner*—Elizabeth A. Albert  
(74) *Attorney, Agent, or Firm*—Adams & Wilks

(57) **CLAIM**

The ornamental design for a cap for writing instrument, as shown and described.

**DESCRIPTION**

FIG. 1 is a perspective view of a cap for writing instrument showing my new design;

FIG. 2 is a front view thereof;

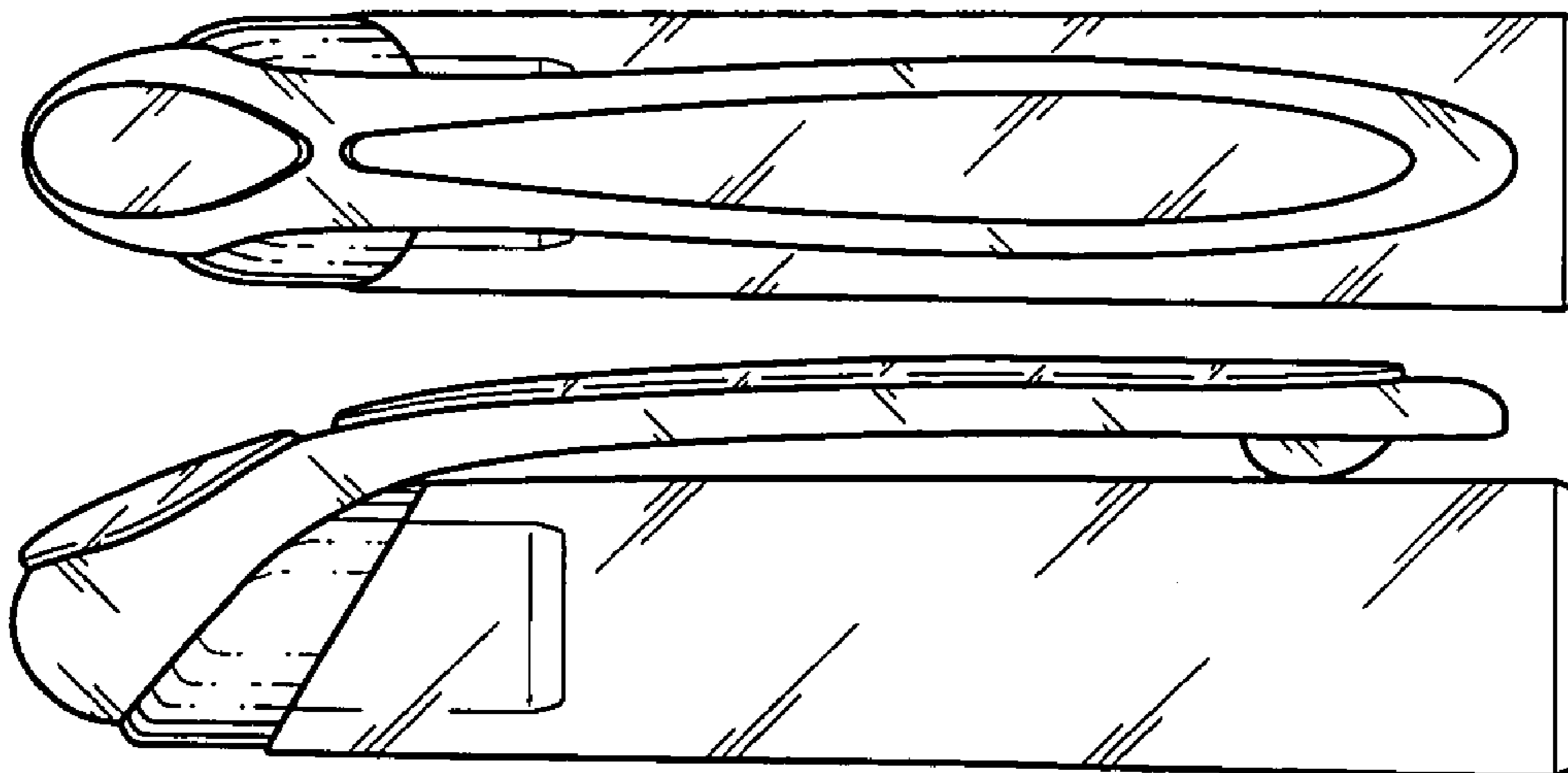
FIG. 3 is a bottom view thereof;

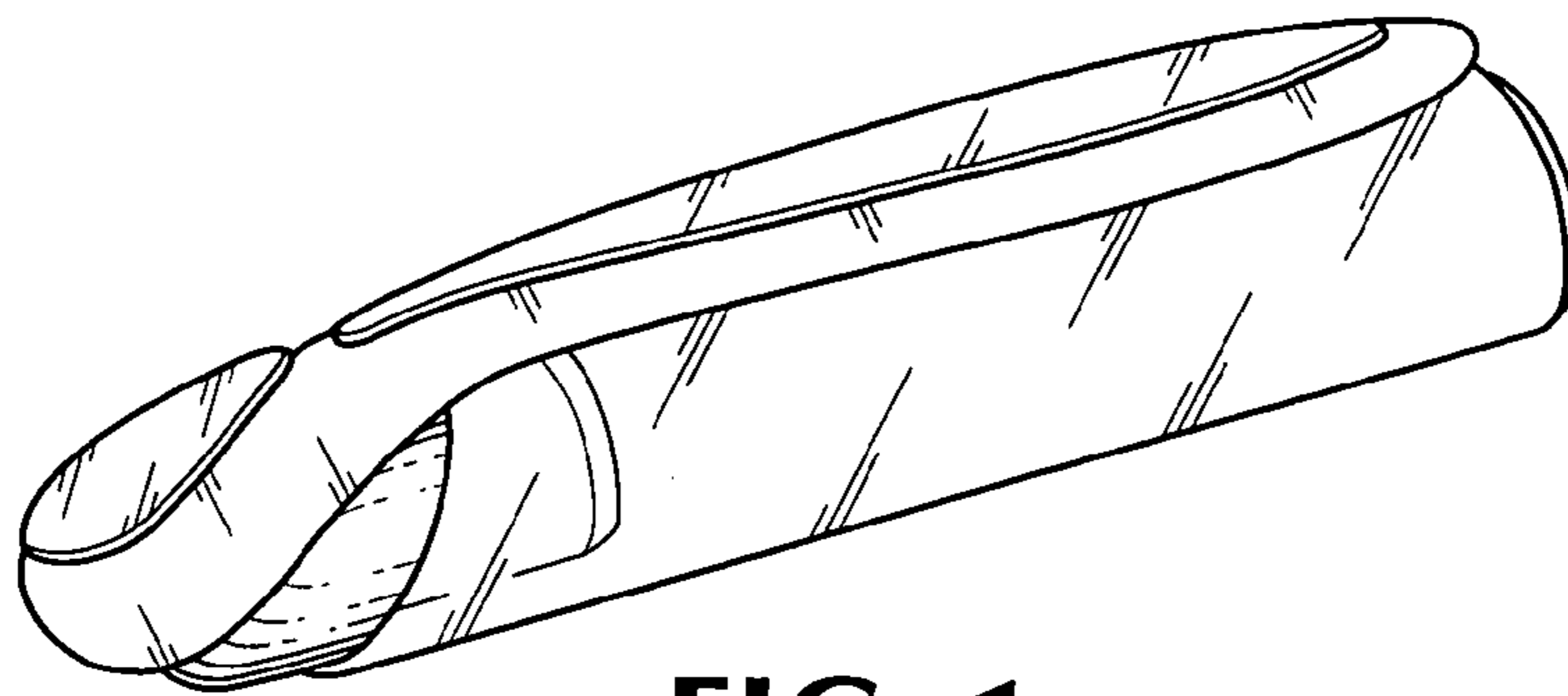
FIG. 4 is a rear view thereof;

FIG. 5 is a right side view thereof; and,

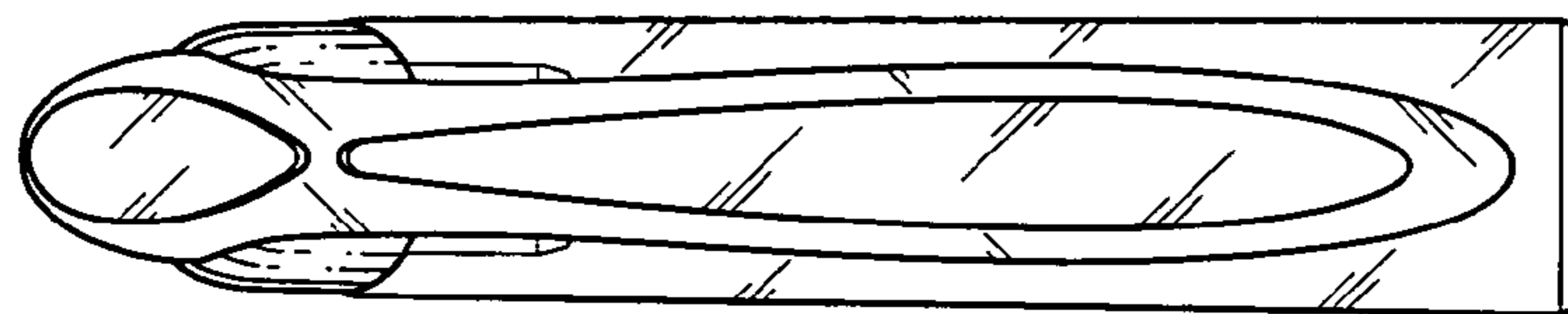
FIG. 6 is a left side view thereof.

**1 Claim, 2 Drawing Sheets**

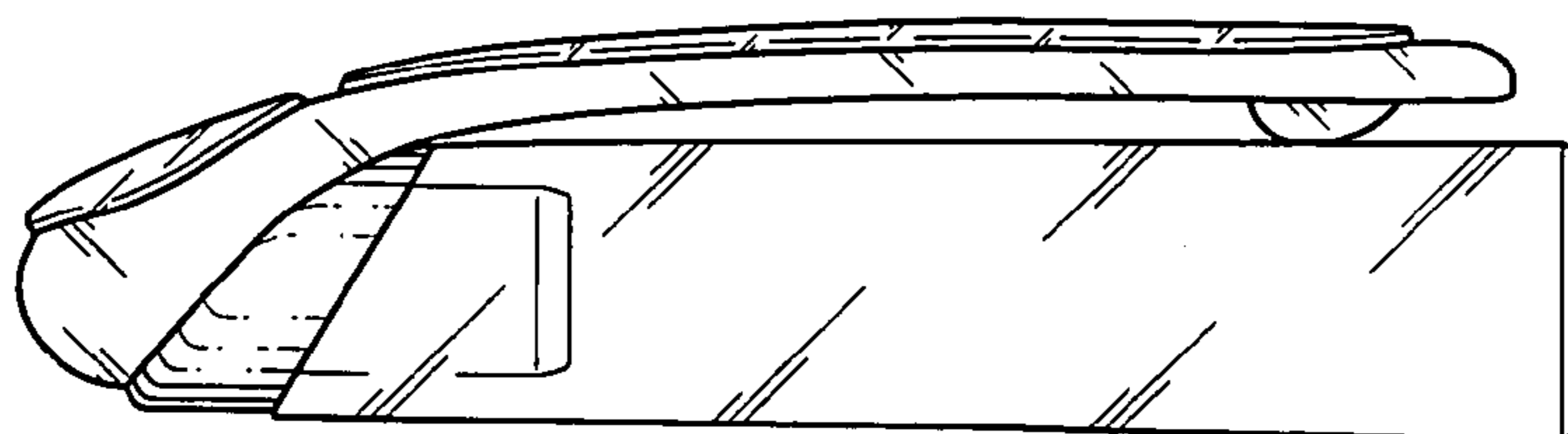




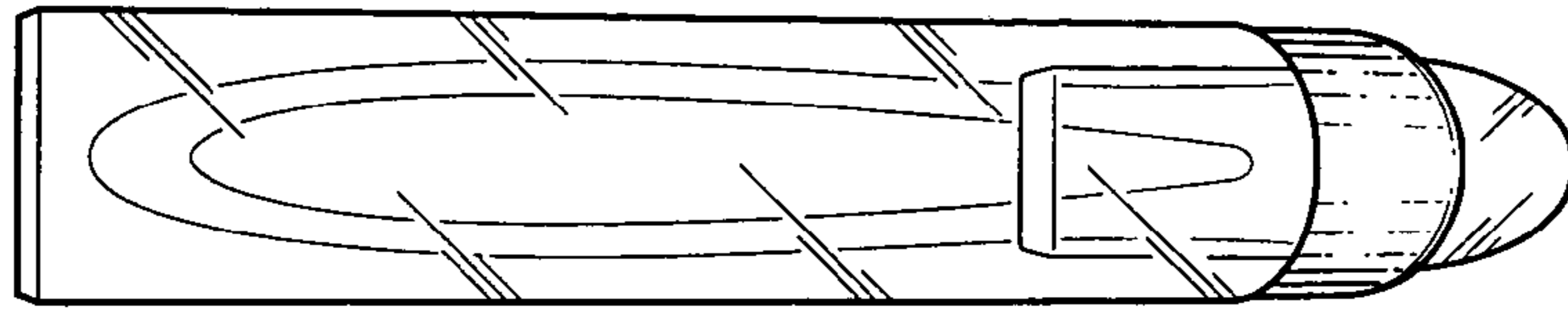
**FIG. 1**



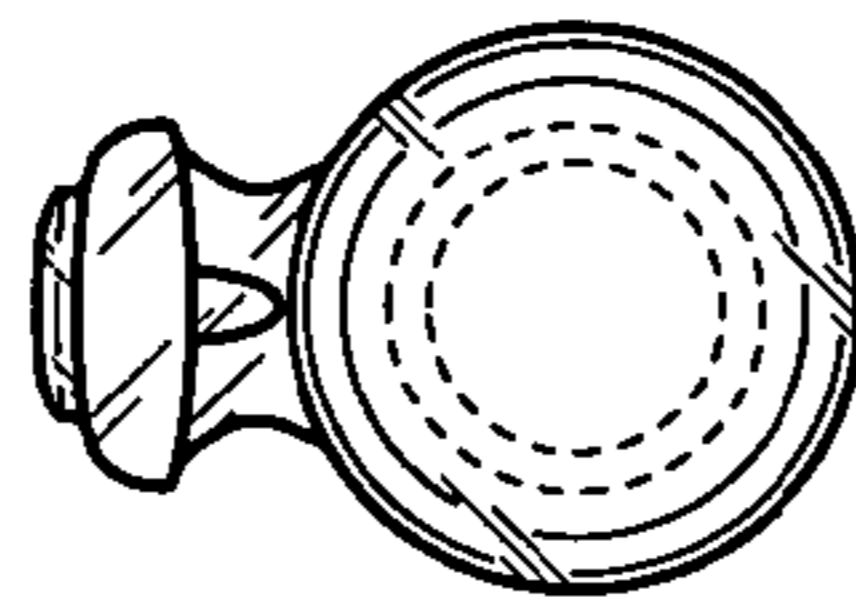
**FIG. 2**



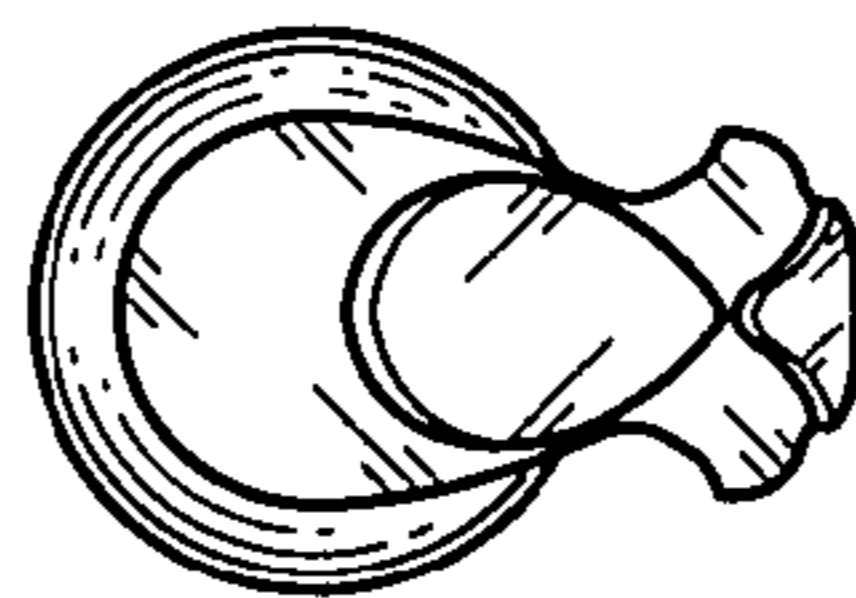
**FIG. 3**



**FIG. 4**



**FIG. 5**



**FIG. 6**