

US00D569383S

(12) **United States Design Patent**  
**Jung et al.**

(10) **Patent No.:** **US D569,383 S**  
(45) **Date of Patent:** **\*\* May 20, 2008**

(54) **GENERATED IMAGE FOR DISPLAY ON A PERSONAL DIGITAL ASSISTANT**

(75) Inventors: **Min-Hwa Jung**, Seoul (KR); **Ho Kim**, Seoul (KR); **Sun-Ki Hong**, Seoul (KR)

(73) Assignee: **Samsung Electronics Co., Ltd.**, Suwon, Kyunggi-Do (KR)

(\*\*) Term: **14 Years**

(21) Appl. No.: **29/253,061**

(22) Filed: **Feb. 1, 2006**

(51) **LOC (8) Cl.** ..... **14-04**

(52) **U.S. Cl.** ..... **D14/486**

(58) **Field of Classification Search** ..... D14/129,  
D14/485-495; 345/426, 442, 594, 609, 610;  
715/500.1, 501.1, 700, 703, 706, 716, 717,  
715/718, 719, 720, 721, 722, 727, 728, 730,  
715/762, 763, 764, 771, 810, 811, 812, 813,  
715/814, 815, 816, 817, 818, 819, 820, 821,  
715/822, 823, 824, 825, 826, 827, 828, 829,  
715/830, 831, 832, 833, 834, 835, 836, 837,  
715/838, 839, 840, 841, 843, 845, 846, 847,  
715/864, 867, 961, 967, 972, 977

See application file for complete search history.

(56) **References Cited**

**U.S. PATENT DOCUMENTS**

5,301,336	A *	4/1994	Kodosky et al. ....	715/846
D445,428	S *	7/2001	Pattenden .....	D14/488
D516,574	S *	3/2006	Ishida et al. ....	D14/488
D517,087	S *	3/2006	Sands .....	D14/488
D522,529	S *	6/2006	Gibson .....	D14/489
D535,658	S *	1/2007	Wang et al. ....	D14/485
2006/0020906	A1 *	1/2006	Plut .....	715/867
2006/0143572	A1 *	6/2006	Scott et al. ....	715/765
2006/0184871	A1 *	8/2006	Waters .....	715/512
2007/0083911	A1 *	4/2007	Madden et al. ....	725/135

**FOREIGN PATENT DOCUMENTS**

EM 000461231-0022 \* 1/2006

**OTHER PUBLICATIONS**

Nokia 6260 GSM 900/1800/1900 Symbian Camera Phone, Dec. 29, 2004, <http://www.ocworkbench.com/2004/nokia/6260/p2.htm>.\*

J100 Phone from Asustek, Sep. 2003, [http://www.apoxi.com/phones\\_asus.html](http://www.apoxi.com/phones_asus.html).\*

(Continued)

*Primary Examiner*—Cathron Brooks

*Assistant Examiner*—Angela J Lee

(74) *Attorney, Agent, or Firm*—Flynn, Thiel, Boutell & Tanis, P.C.

(57) **CLAIM**

The ornamental design for a generated image for display on a personal digital assistant, as shown and described.

**DESCRIPTION**

The file of this patent contains at least one drawing executed in color. Copies of this patent with color drawings will be provided by the Office upon request and payment of the necessary fee.

FIG. 1 is a top front perspective view of a generated image for display on a personal digital assistant showing our new design;

FIG. 2 is a front elevational view thereof;

FIG. 3 is a rear elevational view thereof;

FIG. 4 is a left side elevational view thereof;

FIG. 5 is a right side elevational view thereof;

FIG. 6 is a top plan view thereof;

FIG. 7 is a bottom plan view thereof; and,

FIG. 8 is an enlargement of the image area shown in FIG. 2.

The broken line showing of a personal digital assistant is included for the purpose of illustrating environmental structure and forms no part of the claimed design.

**1 Claim, 6 Drawing Sheets**  
**(3 of 6 Drawing Sheet(s) Filed in Color)**

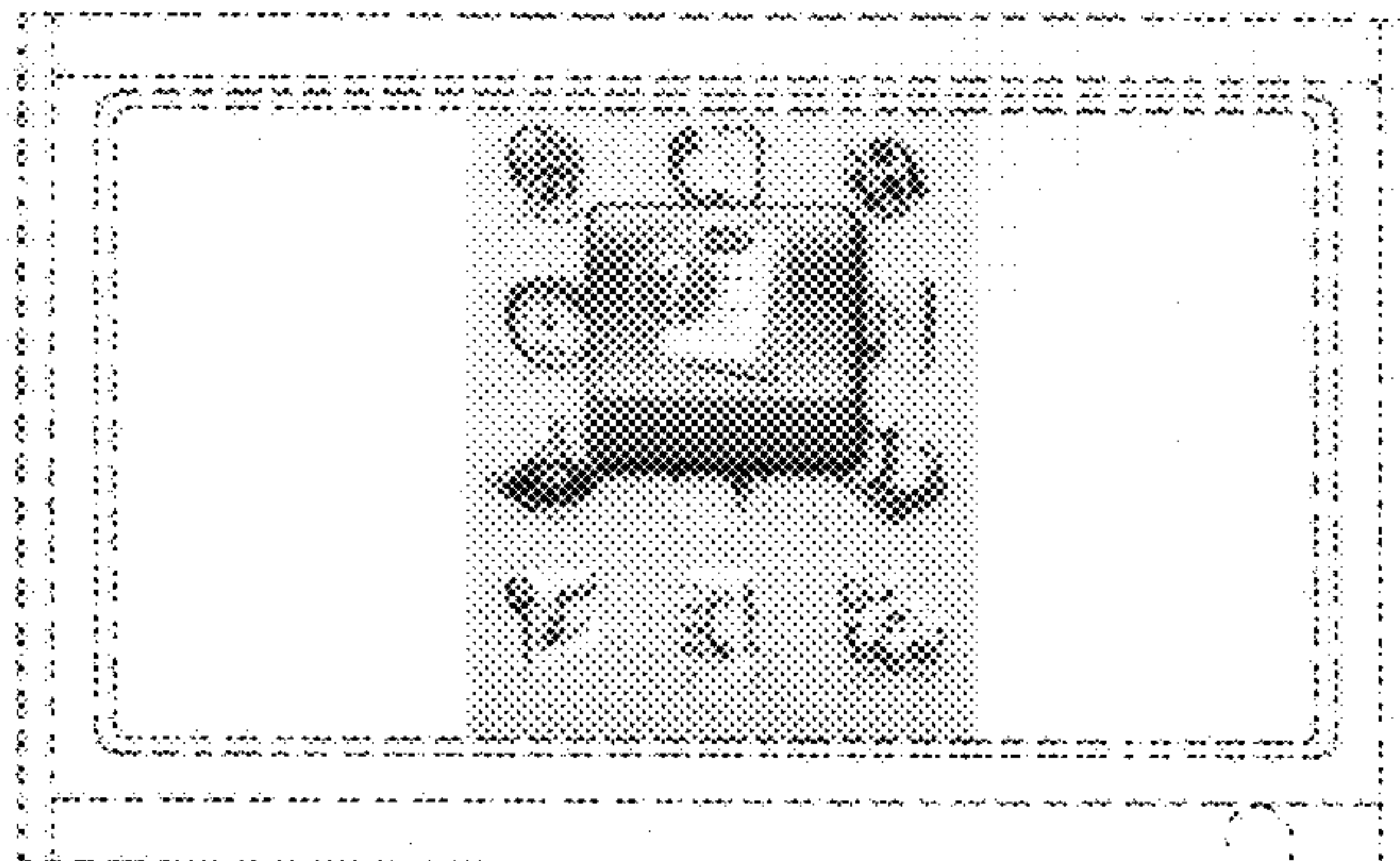

## OTHER PUBLICATIONS

Sony Ericsson K700, Mar. 2004, [http://www.gsmarena.com/sony\\_ericsson\\_k700-692.php](http://www.gsmarena.com/sony_ericsson_k700-692.php).\*

U.S. Appl. No. 29/228,103, Applicant: Jee-Yeun Wang, et al. filed Apr. 20, 2005 entitled Portable Telephone Having Indicating Image Design Displayed Thereon.

U.S. Appl. No. 29/228,104, Applicant: Hong-Hee Kim, et al. filed Apr. 20, 2005 entitled Portable Telephone Having Indicating Image Design Displayed Thereon.

U.S. Appl. No. 29/228,149, Applicant: Ae-Jung Seo, et al. filed Apr. 20, 2005 entitled Portable Telephone Having Indicating Image Design Displayed Thereon.

U.S. Appl. No. 29/228,150, Applicant: Sun-Young Kim, et al. filed Apr. 20, 2005 entitled Monitor Having Home Network Indicating Image Design Displayed Thereon.

U.S. Appl. No. 29/236,447, Applicant: So-Young Shin, et al. filed Aug. 16, 2005 entitled Computer Monitor Having Indicating Image Design Displayed Thereon.

U.S. Appl. No. 29/236,448, Applicant: Yi-Sak Park, et al. filed Aug. 16, 2005 entitled Telephone Having Indicating Image Design Displayed Thereon.

U.S. Appl. No. 29/236,446, Applicant: Yi-Sak Park, et al. filed Aug. 16, 2005 entitled Computer Monitor Having Indicating Image Design Displayed Thereon.

U.S. Appl. No. 29/236,449, Applicant: So-Young Shin, et al. filed Aug. 16, 2005 entitled Portable Telephone Having Indicating Image Design Thereon.

U.S. Appl. No. 29/243,947, Applicant: Ji-Hoon Kim, et al. filed Dec. 2, 2005 entitled Portable Telephone Having Indicated Image Design Displayed Thereon.

U.S. Appl. No. 29/243,945, Applicant: Ji-Hoon Kim, et al. filed Dec. 2, 2005 entitled Portable Telephone Having Indicated Image Design Displayed Thereon.

U.S. Appl. No. 29/244,137, Applicant: Ji-Hoon Kim, et al. filed Dec. 6, 2005 entitled Television Receiver Having Indicated Image Design Displayed Thereon.

U.S. Appl. No. 29/244,152, Applicant: Ji-Hoon Kim, et al. filed Dec. 6, 2005 entitled Television Receiver Having Indicated Image Design Displayed Thereon.

U.S. Appl. No. 29/243,948, Applicant: Dok-Shin Lim, et al. filed Dec. 2, 2005 entitled Portable Telephone Having Indicated Image Design Displayed Thereon.

U.S. Appl. No. 29/251,184, Applicant: Young-Jae Ryu, et al. filed Jan. 4, 2006 entitled Pop-Up Window for a User Interface for a Television Receiver.

U.S. Appl. No. 29/251,186, Applicant: Joo-Hoon Park, et al. filed Jan. 4, 2006 entitled User Interface for a Television Receiver.

U.S. Appl. No. 29/251,185, Applicant: Young-Jae Ryu, et al. filed Jan. 4, 2006 entitled Pop-Up Window for a User Interface for a Television Receiver.

U.S. Appl. No. 29/252,004, Applicant: Young-Jae Ryu, et al. filed Jan. 17, 2006 entitled User Interface for a Television Receiver.

U.S. Appl. No. 29/252,005, Applicant: Young-Jae Ryu, et al. filed Jan. 17, 2006 entitled User Interface for a Television Receiver.

U.S. Appl. No. 29/252,002, Applicant: Young-Jae Ryu, et al. filed Jan. 17, 2006 entitled Pop-Up Window for User Interface for a Television Receiver.

U.S. Appl. No. 29/252,008, Applicant: Young-Jae Ryu, et al. filed Jan. 17, 2006 entitled User Interface for a Television Receiver.

U.S. Appl. No. 29/252,007, Applicant: Young-Jae Ryu, et al. filed Jan. 17, 2006 entitled User Interface for a Television Receiver.

U.S. Appl. No. 29/244,153, Applicant: Ji-Hoon Kim, et al., filed Dec. 6, 2005 entitled Television Receiver Having Indicated Image Design Displayed Thereon.

U.S. Appl. No. 29/253,099, Applicant: Kyu-Sung Kim, filed Feb. 1, 2006 entitled Portable Telephone Having Indicated Image Design Displayed Thereon.

U.S. Appl. No. 29/253,063, Applicant: Kyu-Sung Kim, filed Feb. 1, 2006 entitled Personal Digital Assistant Having Indicated Image Design Displayed Thereon.

U.S. Appl. No. 29/253,101, Applicant: Min-Hwa Jung, et al., filed Feb. 1, 2006 entitled Portable Telephone Having Indicated Image Design Displayed Thereon.

U.S. Appl. No. 29/253,062, Applicant: Min-Hwa Jung, et al., filed Feb. 1, 2006 entitled Personal Digital Assistant Having Indicated Image Design Displayed Thereon.

U.S. Appl. No. 29/253,100, Applicant: Min-Hwa Jung, et al., filed Feb. 1, 2006 entitled Portable Telephone Having Indicated Image Design Displayed Thereon.

U.S. Appl. No. 29/253,098, Applicant: Min-Hwa Jung, et al., filed Feb. 1, 2006 entitled Portable Telephone Having Indicated Image Design Displayed Thereon.

U.S. Appl. No. 29/253,097, Applicant: Ho Kim, et al., filed Feb. 1, 2006 entitled Portable Telephone Having Indicated Image Design Displayed Thereon.

\* cited by examiner



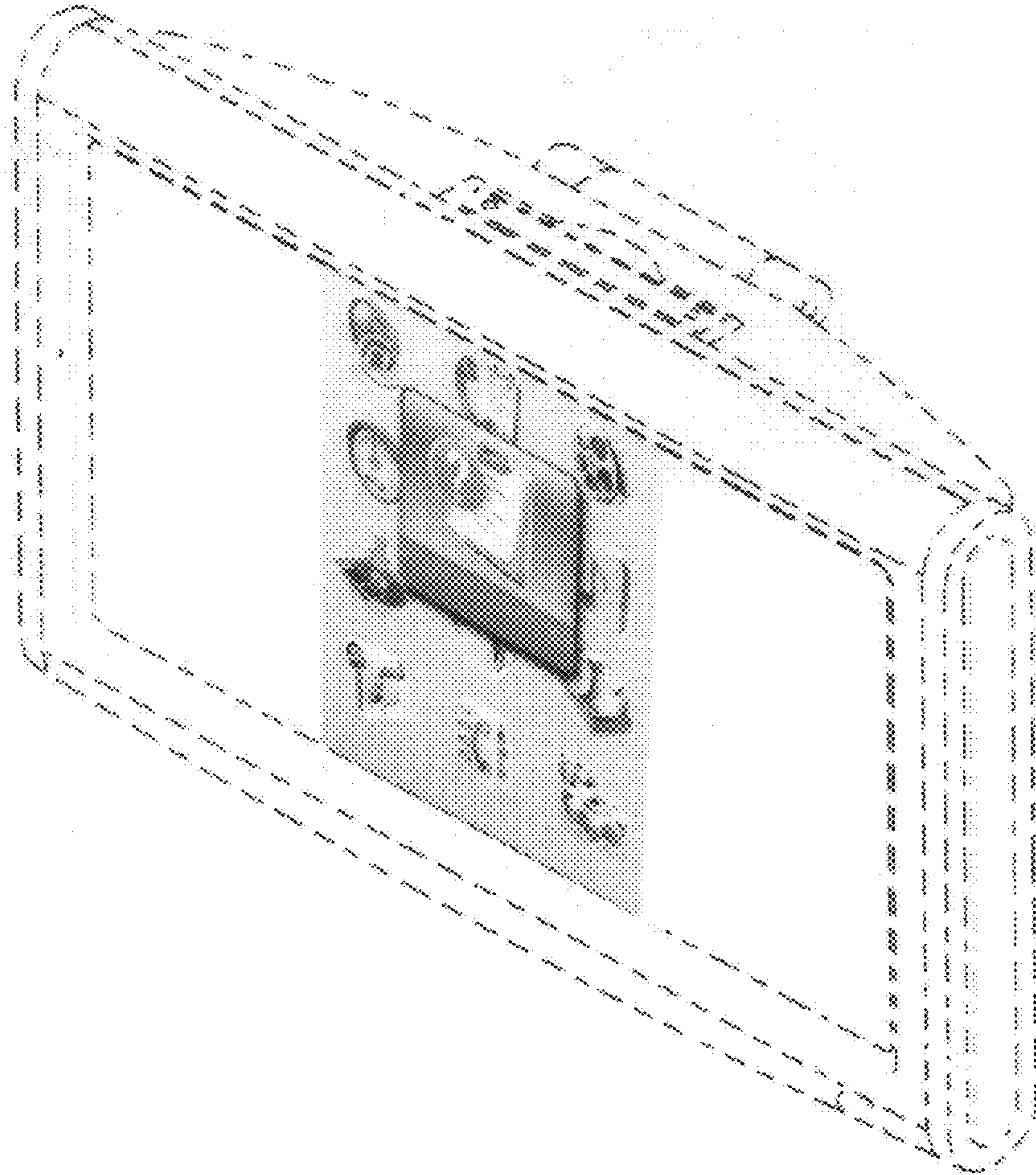

FIG. 1

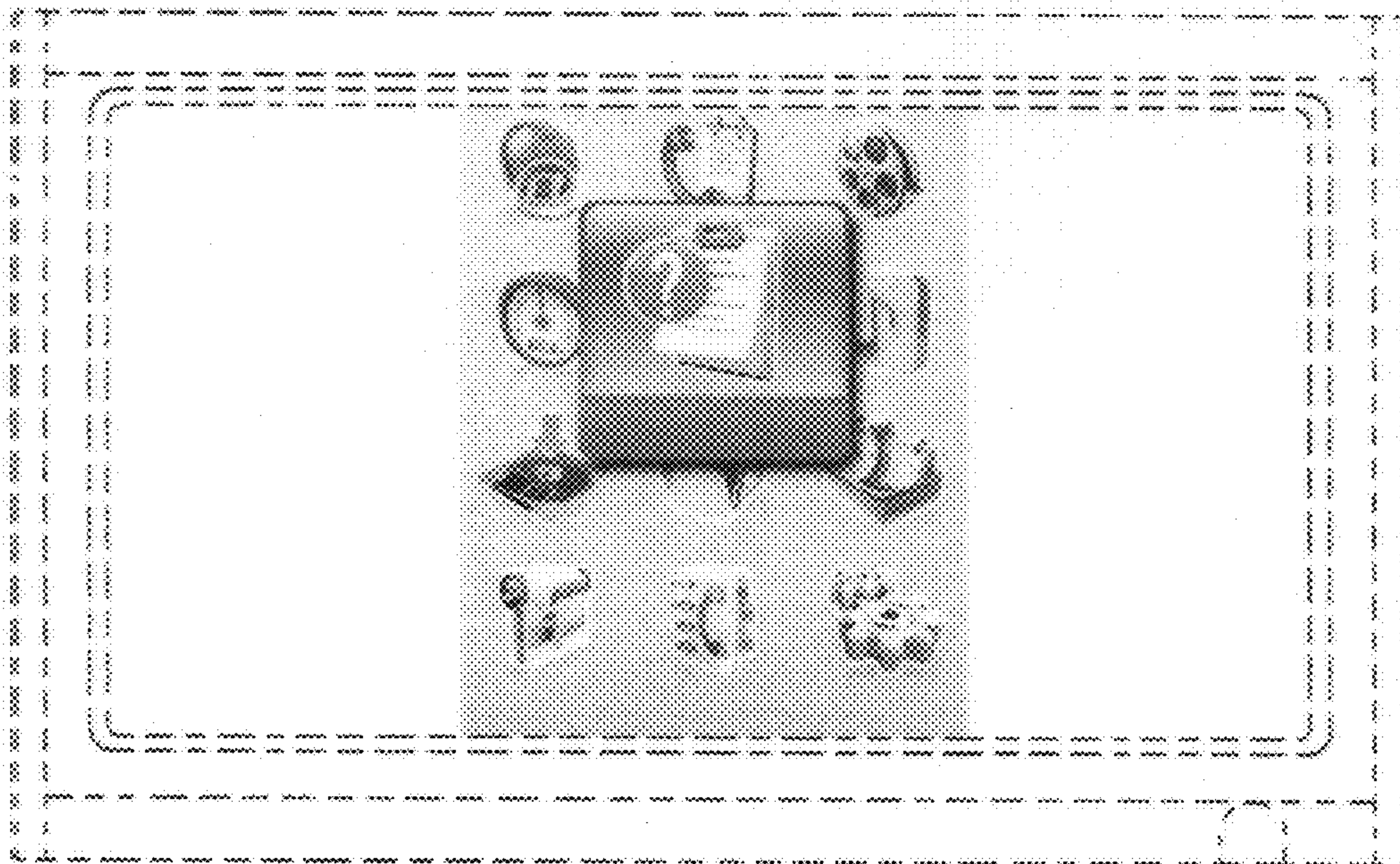

FIG. 2

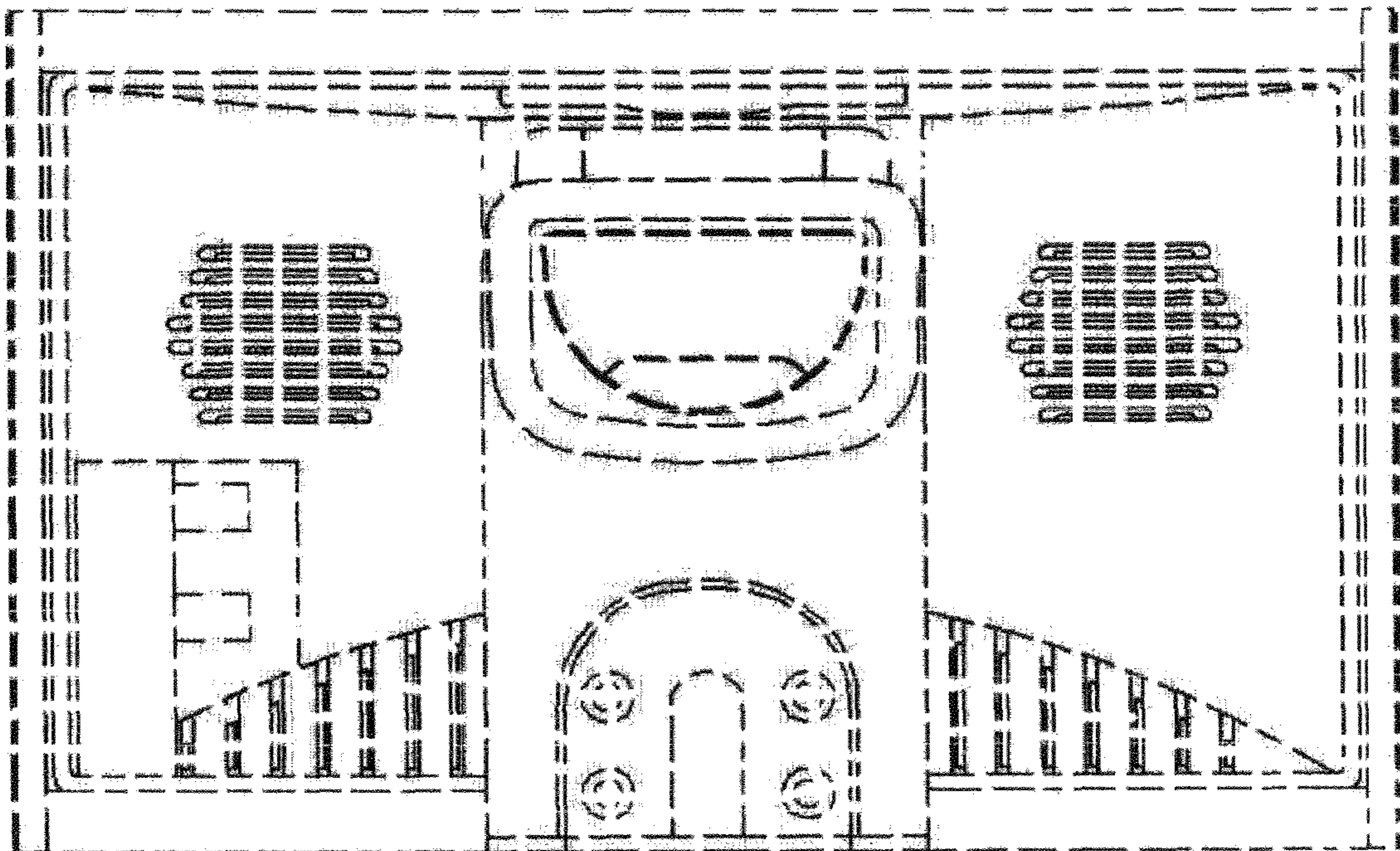

FIG. 3



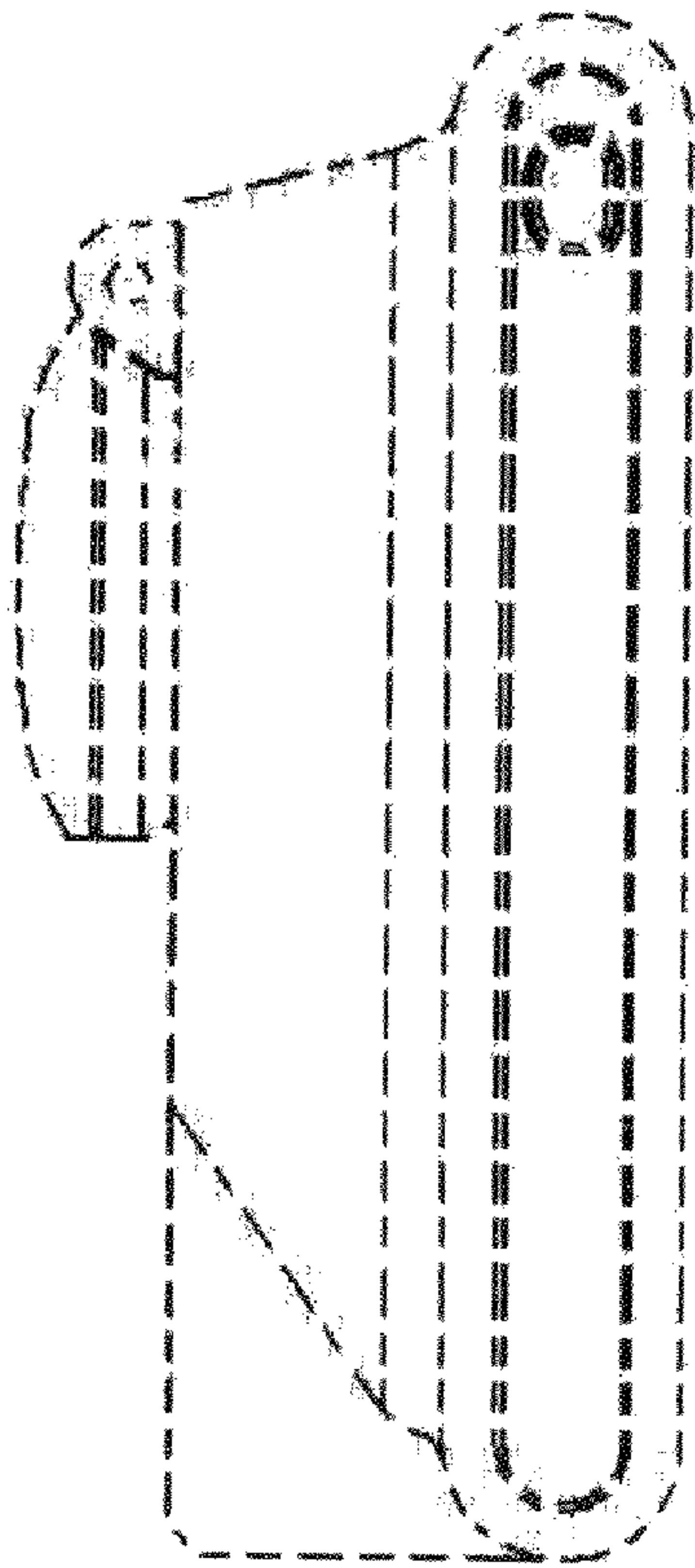

FIG. 4

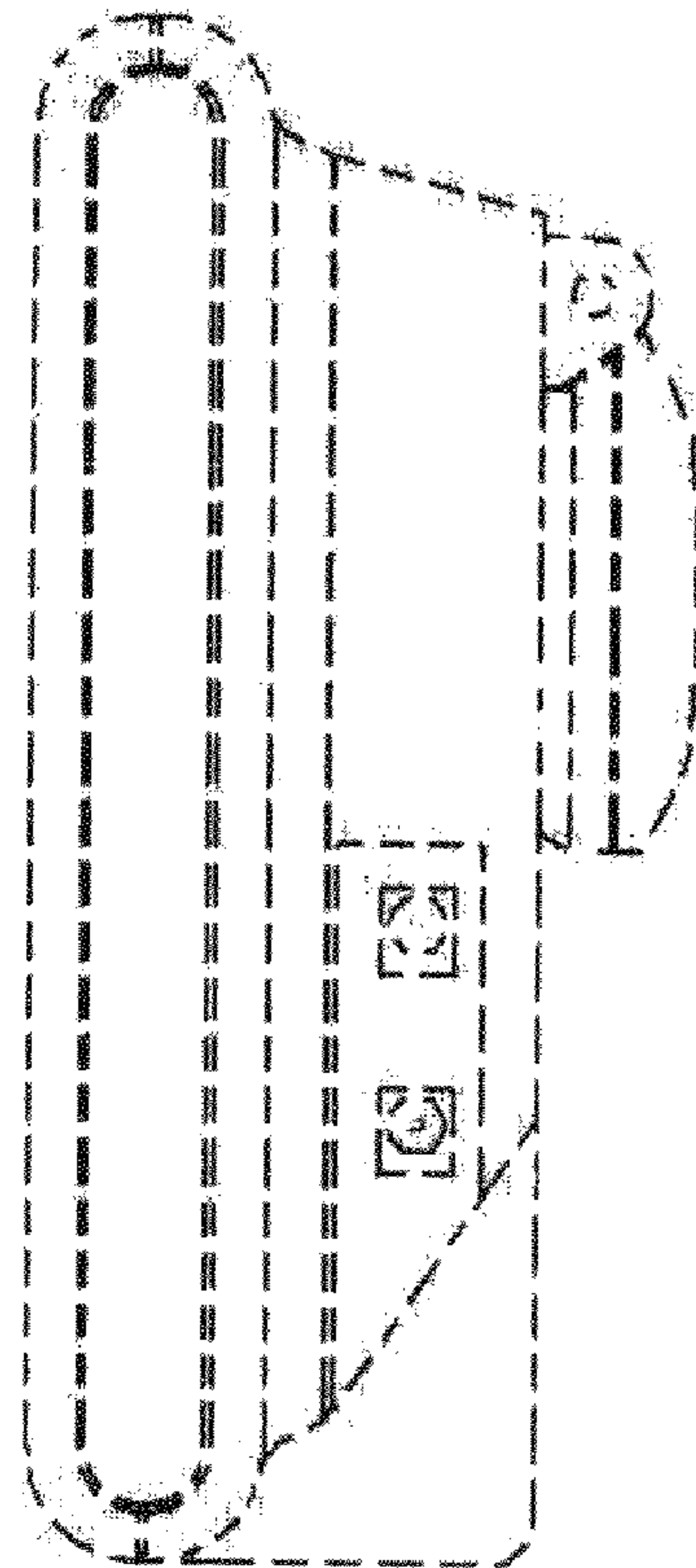

FIG. 5

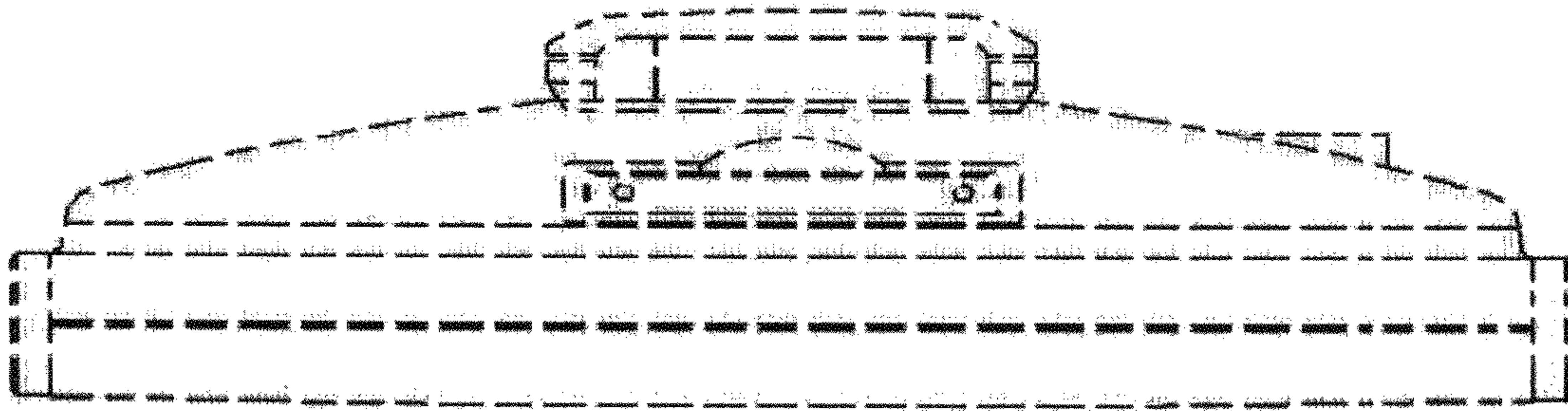

FIG. 6

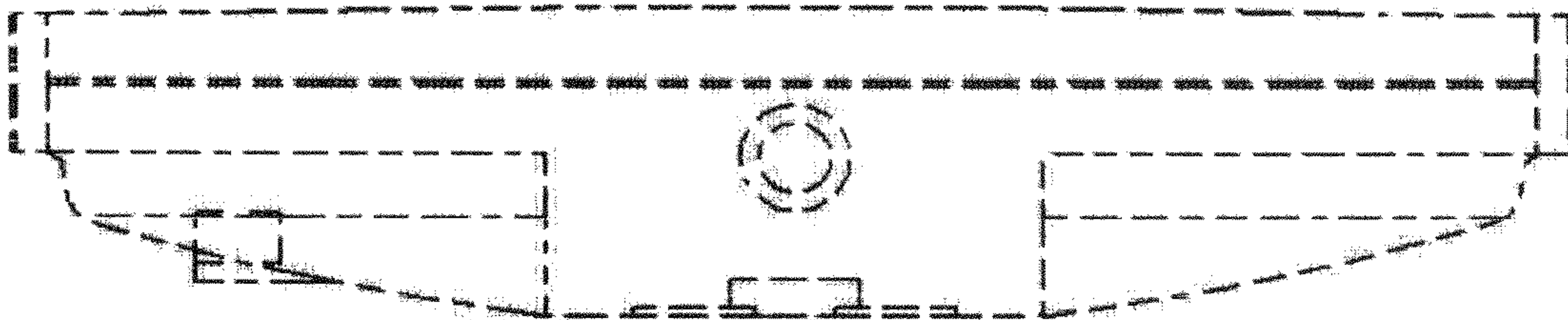

FIG. 7



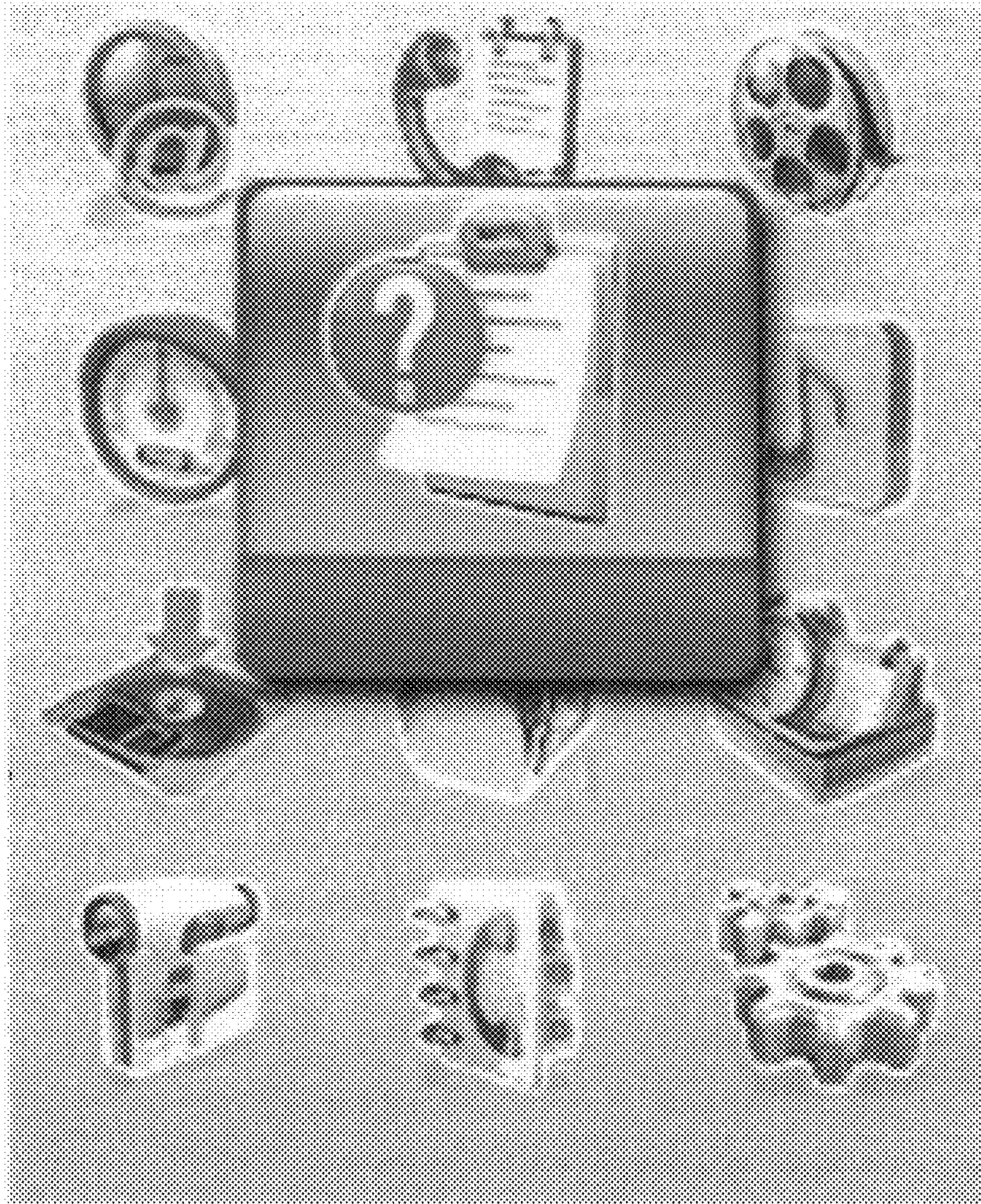

FIG. 8