



US00D569229S

(12) **United States Design Patent**
Johns

(10) **Patent No.:** **US D569,229 S**

(45) **Date of Patent:** **** May 20, 2008**

(54) **BALUSTER SPACER**

(76) Inventor: **Bradley W. Johns**, 1250 New Natchitoches Rd., West Monroe, LA (US) 71292

(**) Term: **14 Years**

(21) Appl. No.: **29/229,920**

(22) Filed: **May 16, 2005**

(51) **LOC (8) Cl.** **08-05**

(52) **U.S. Cl.** **D8/354**

(58) **Field of Classification Search** D8/354, D8/349; D25/38; 33/558.02, 23.01, 23.04, 33/613, 645

See application file for complete search history.

(56) **References Cited**

U.S. PATENT DOCUMENTS

6,032,378	A *	3/2000	Null	33/613
D463,575	S *	9/2002	Daudet et al.	D25/61
D473,123	S *	4/2003	Anderson	D8/354
D490,546	S *	5/2004	Walker	D25/199
6,854,196	B2 *	2/2005	Burrell et al.	33/558.02
2004/0200087	A1 *	10/2004	Killen	33/613

* cited by examiner

Primary Examiner—Holly H Baynham
(74) *Attorney, Agent, or Firm*—John M. Harrison

(57) **CLAIM**

The ornamental design for a baluster spacer, as shown and described.

DESCRIPTION

FIG. 1 is a front perspective view of the baluster spacer, showing my new design;

FIG. 2 is a rear perspective view of the baluster spacer;

FIG. 3 is a front side elevational view thereof;

FIG. 4 is a side elevational view thereof;

FIG. 5 is a rear elevational view, the opposite side being identical thereto;

FIG. 6 is a top view thereof; and,

FIG. 7 is a bottom view of the baluster spacer illustrated in FIGS. 1–6.

The broken lines illustrating environmental structure are for illustrative purposes only and form no part of the claimed design.

1 Claim, 3 Drawing Sheets

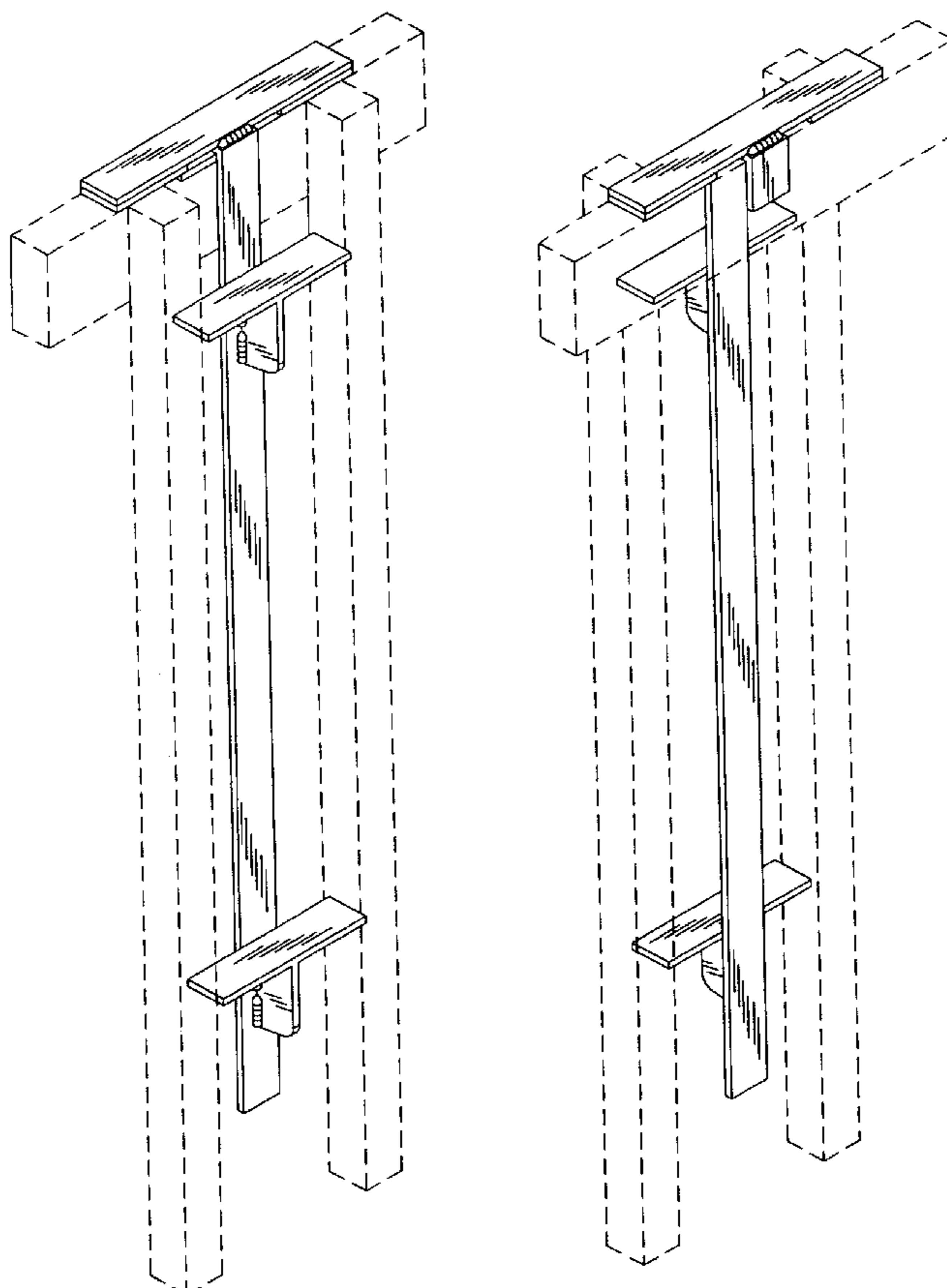

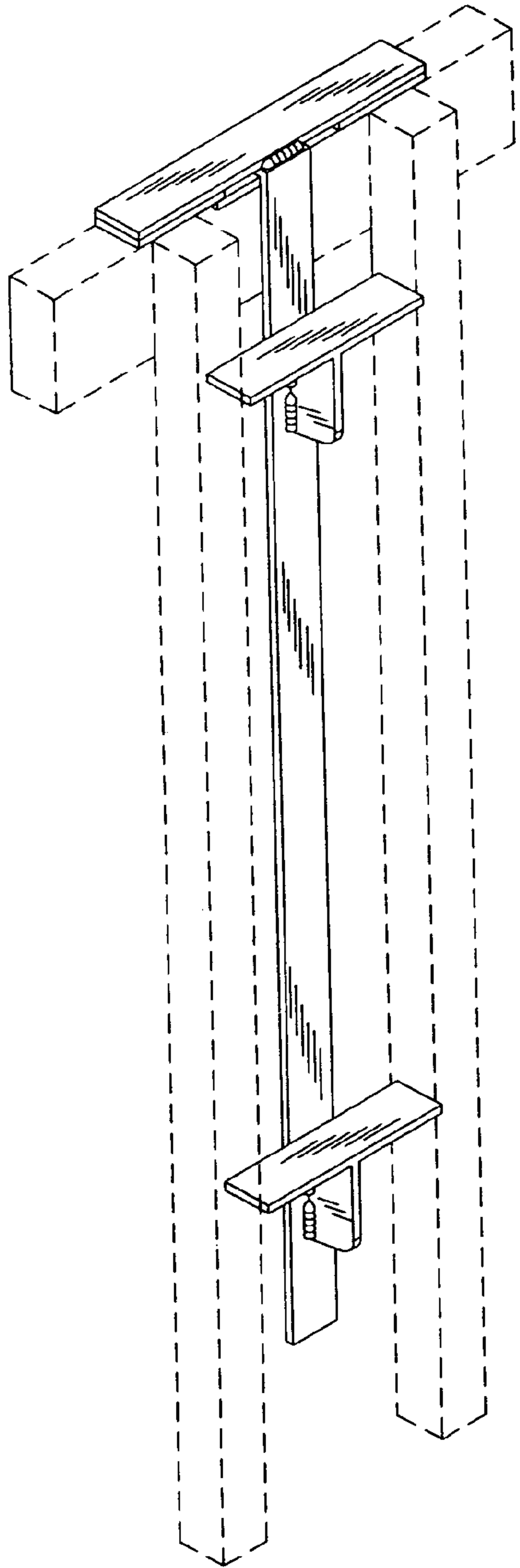

FIG. 1

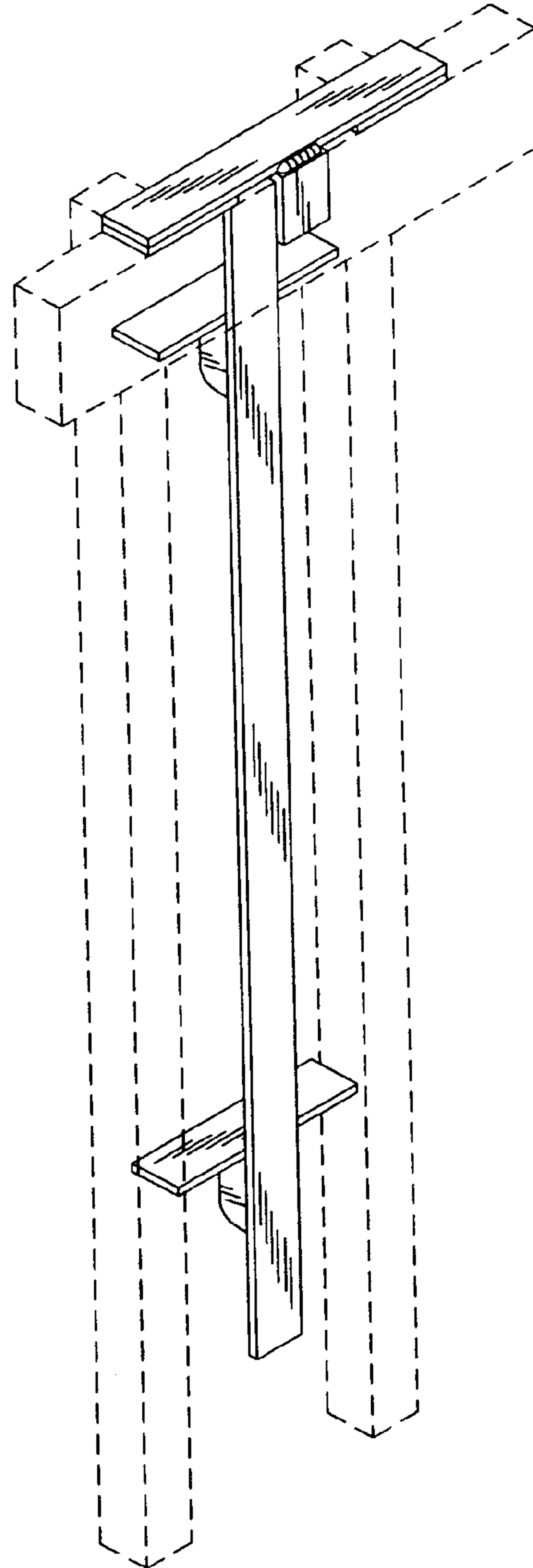

FIG. 2

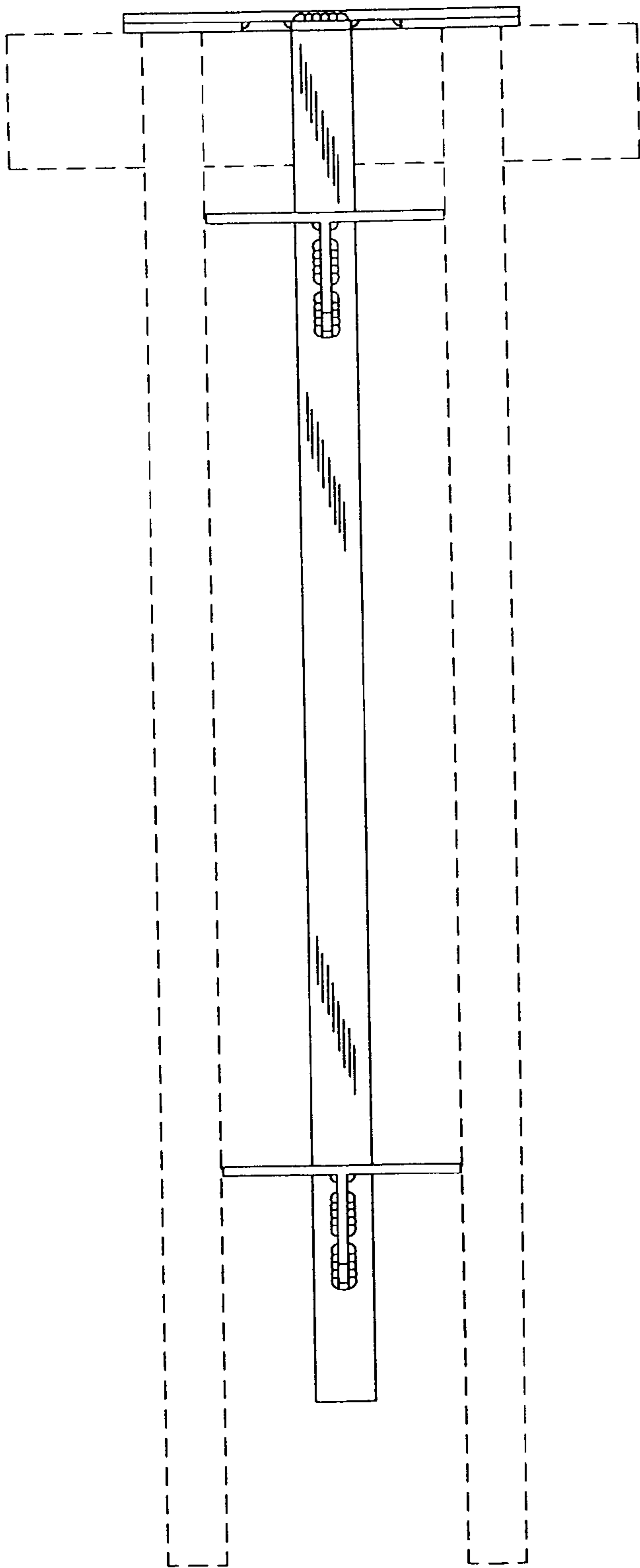

FIG. 3

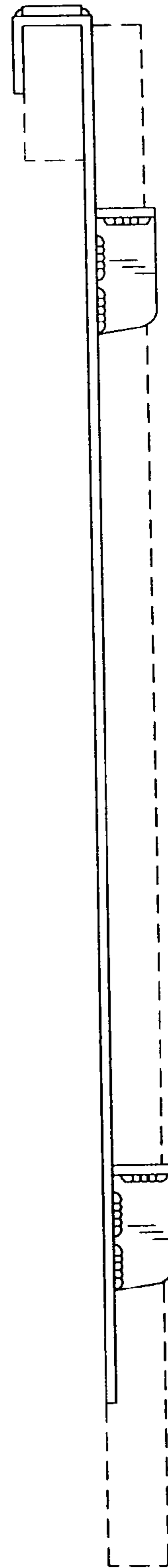

FIG. 4

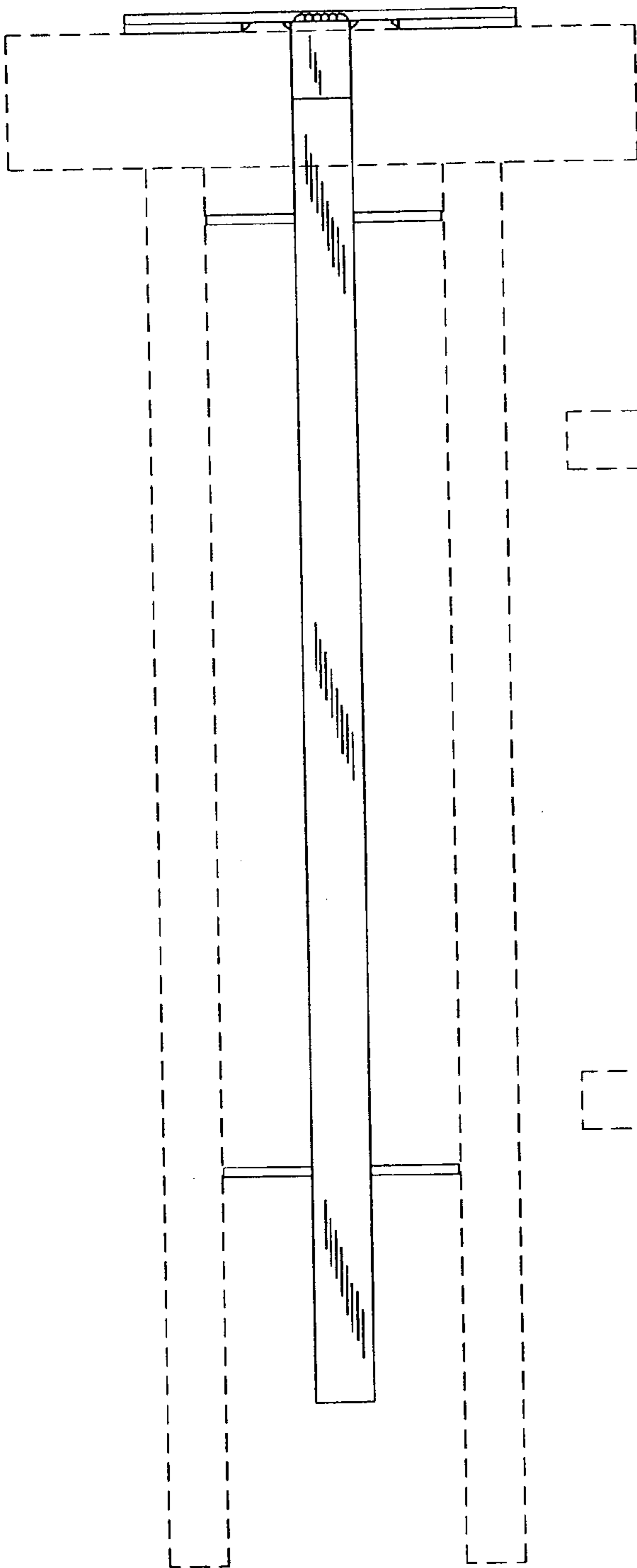

FIG. 5

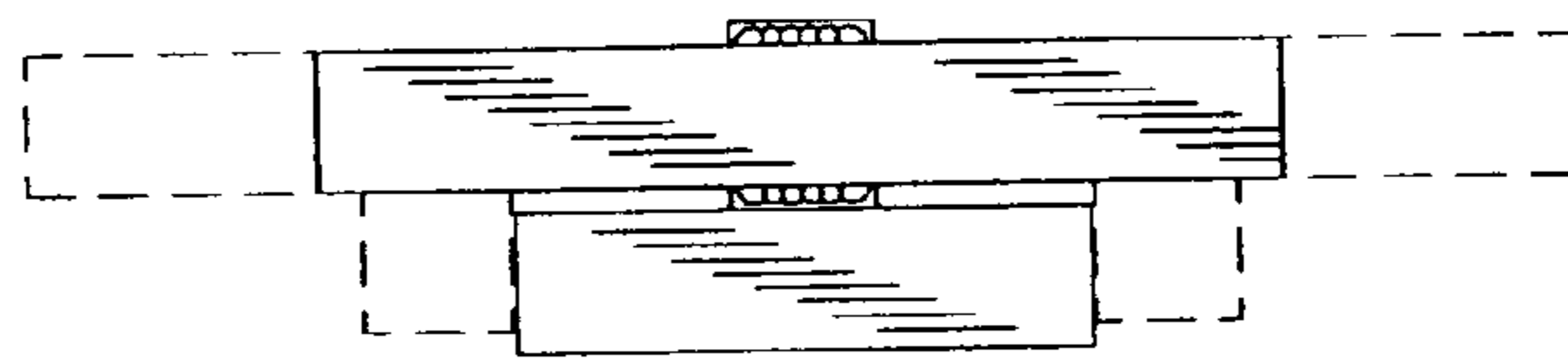

FIG. 6

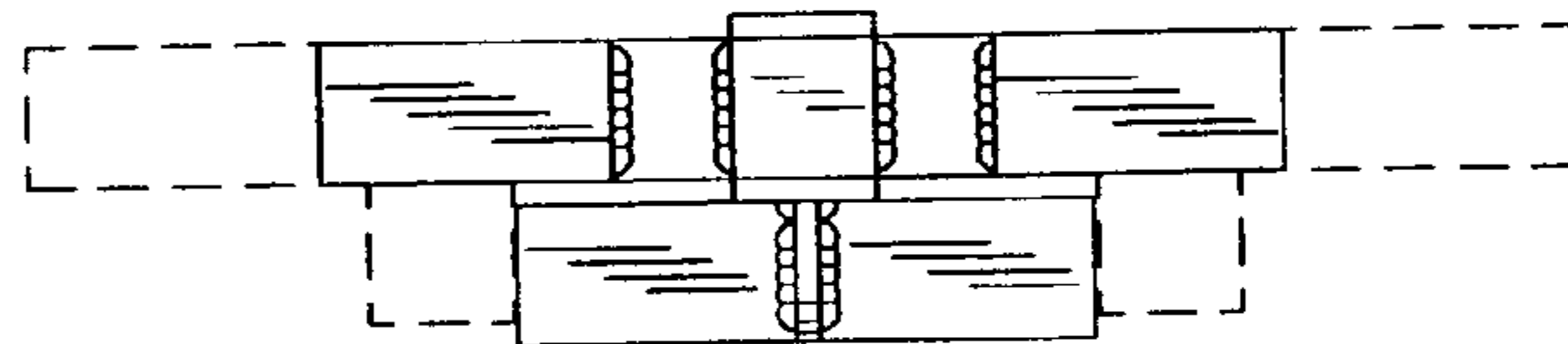

FIG. 7