



US00D569135S

(12) **United States Design Patent**
Galati, Jr. et al.

(10) **Patent No.:** **US D569,135 S**

(45) **Date of Patent:** **** May 20, 2008**

(54) **FOOT SPA BASE**

D548,987 S * 8/2007 McNae D6/344

(75) Inventors: **Joseph J. Galati, Jr.**, Brookfield, WI (US); **John Meyerovich**, Bal Harbour, FL (US)

* cited by examiner

Primary Examiner—Sandra Snapp
(74) *Attorney, Agent, or Firm*—Ryan Kromholz & Manion, S.C.

(73) Assignee: **Continuum Footspas, LLC**, Brookfield, WI (US)

(57) **CLAIM**

(**) Term: **14 Years**

The ornamental design for a foot spa base, as shown and described.

(21) Appl. No.: **29/291,291**

(22) Filed: **Aug. 22, 2007**

DESCRIPTION

(51) **LOC (8) Cl.** **06-01**

FIG. 1 is a perspective view of our foot spa base;

(52) **U.S. Cl.** **D6/495**

FIG. 2 is a front plan view;

(58) **Field of Classification Search** D6/334-338, D6/360, 367, 374, 375, 482, 491, 495, 500-502, D6/357, 364; 297/83, 157.1, 158.3, 170, 297/184.16, 188.14, 244, 423.19; 5/12.1, 5/12.2

FIG. 3 is a back plan view;

FIG. 4 is a top plan view;

FIG. 5 is a right side elevation view; and,

FIG. 6 is a left side elevation view.

See application file for complete search history.

The broken line showing of a seat and bowl in FIGS. 1-6 is illustrative of environmental structure only and forms no part of the claimed design.

(56) **References Cited**

U.S. PATENT DOCUMENTS

1 Claim, 4 Drawing Sheets

D288,993 S * 3/1987 Grimsrud D6/361

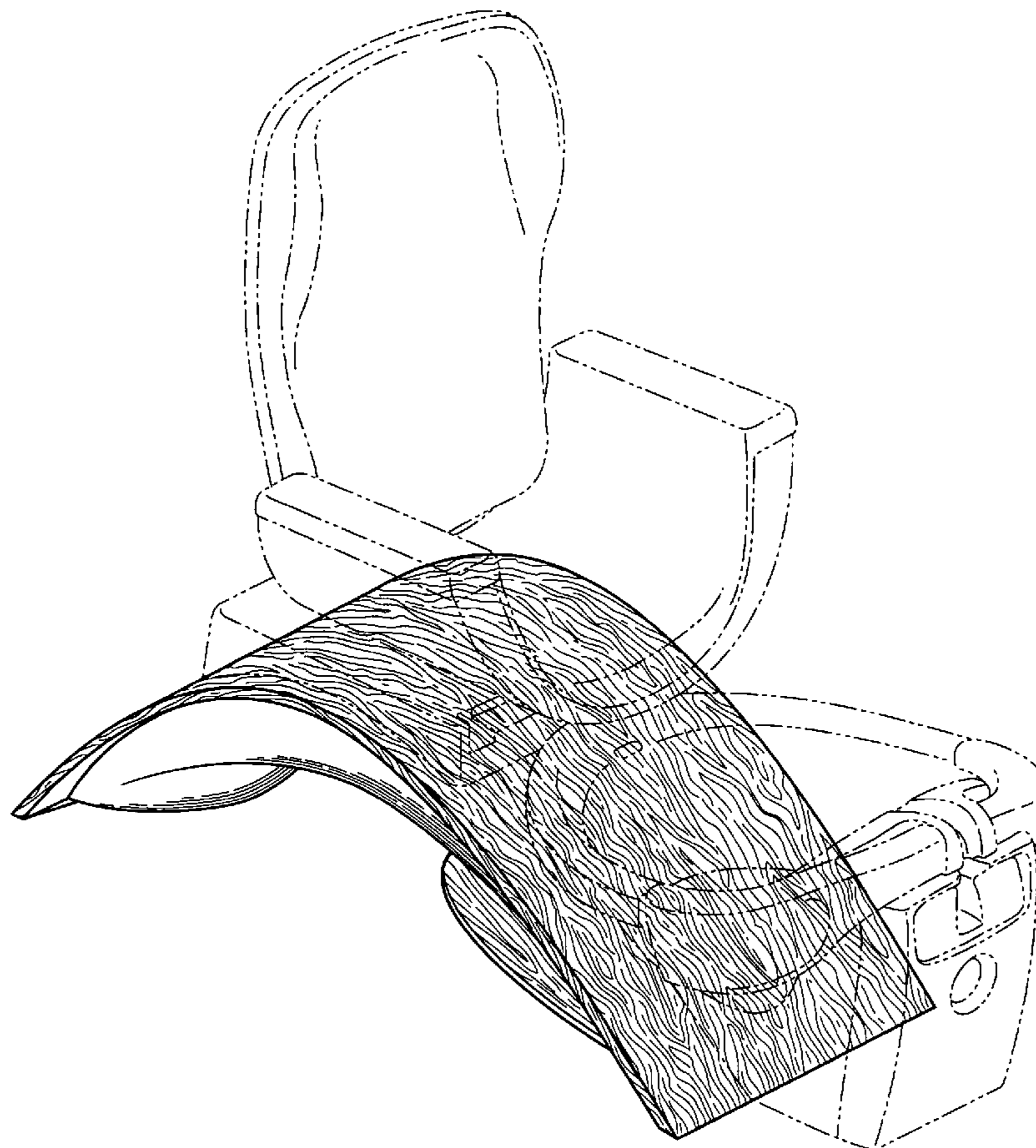

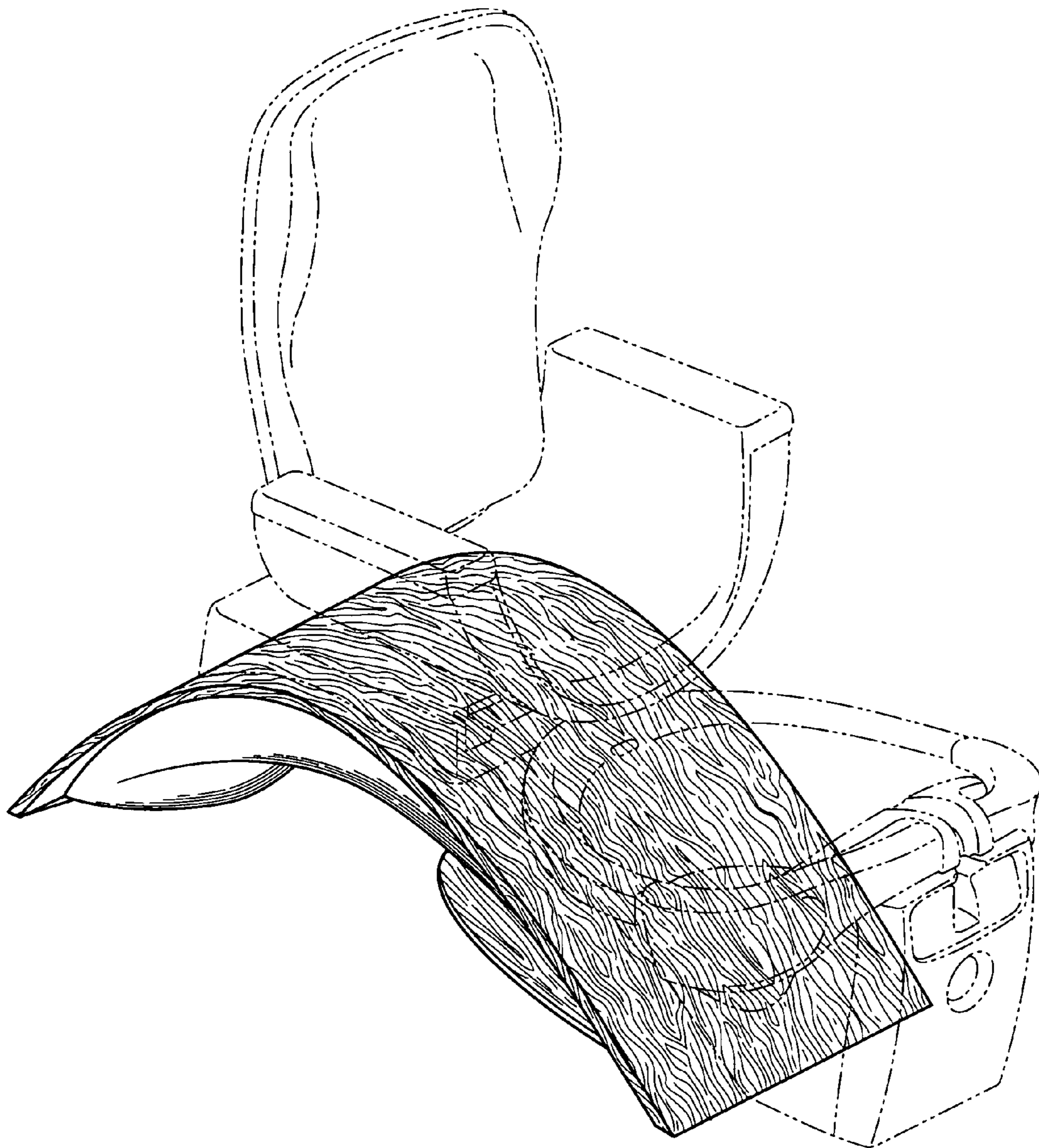

Fig. 1

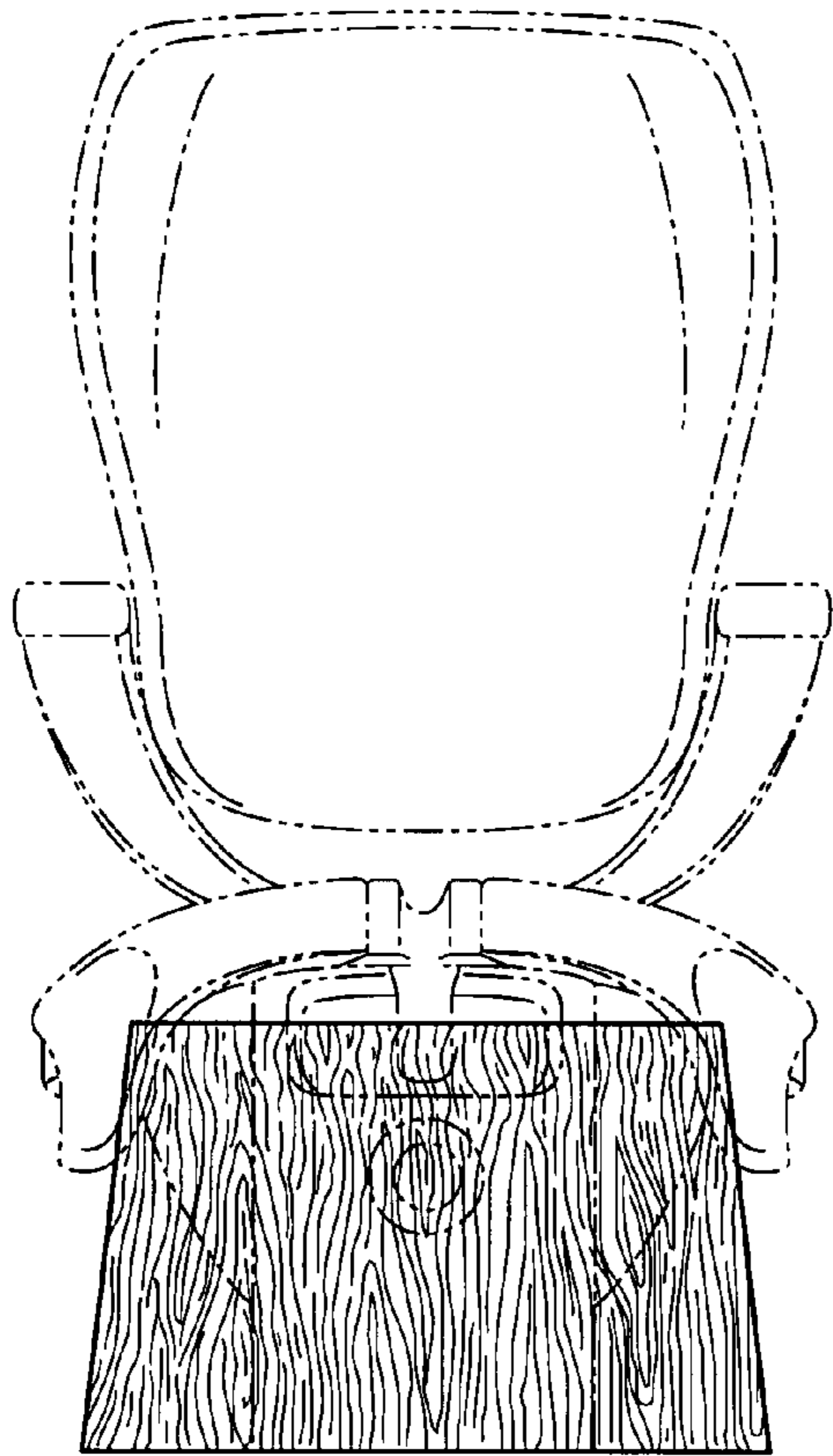

Fig. 2

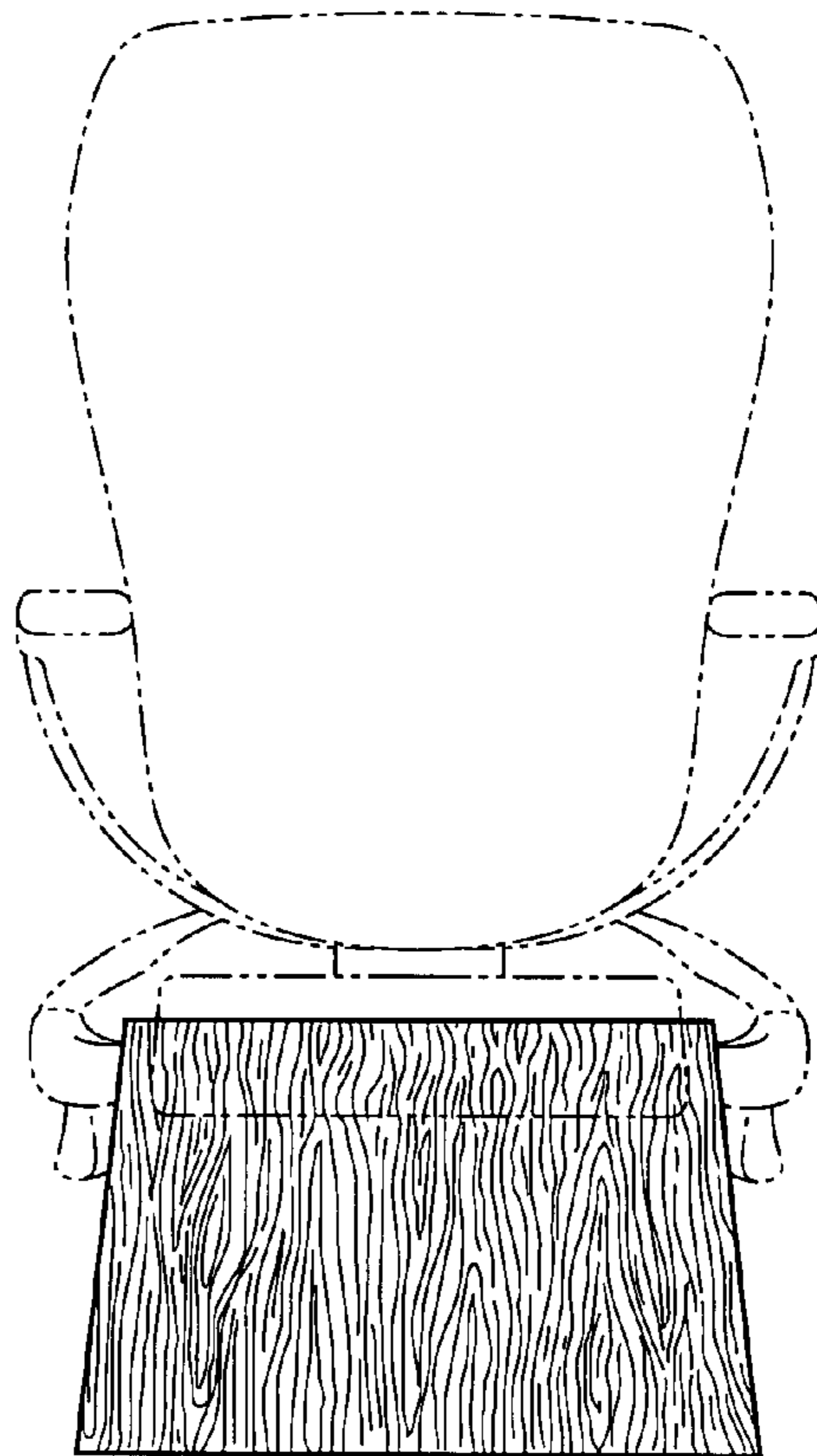

Fig. 3

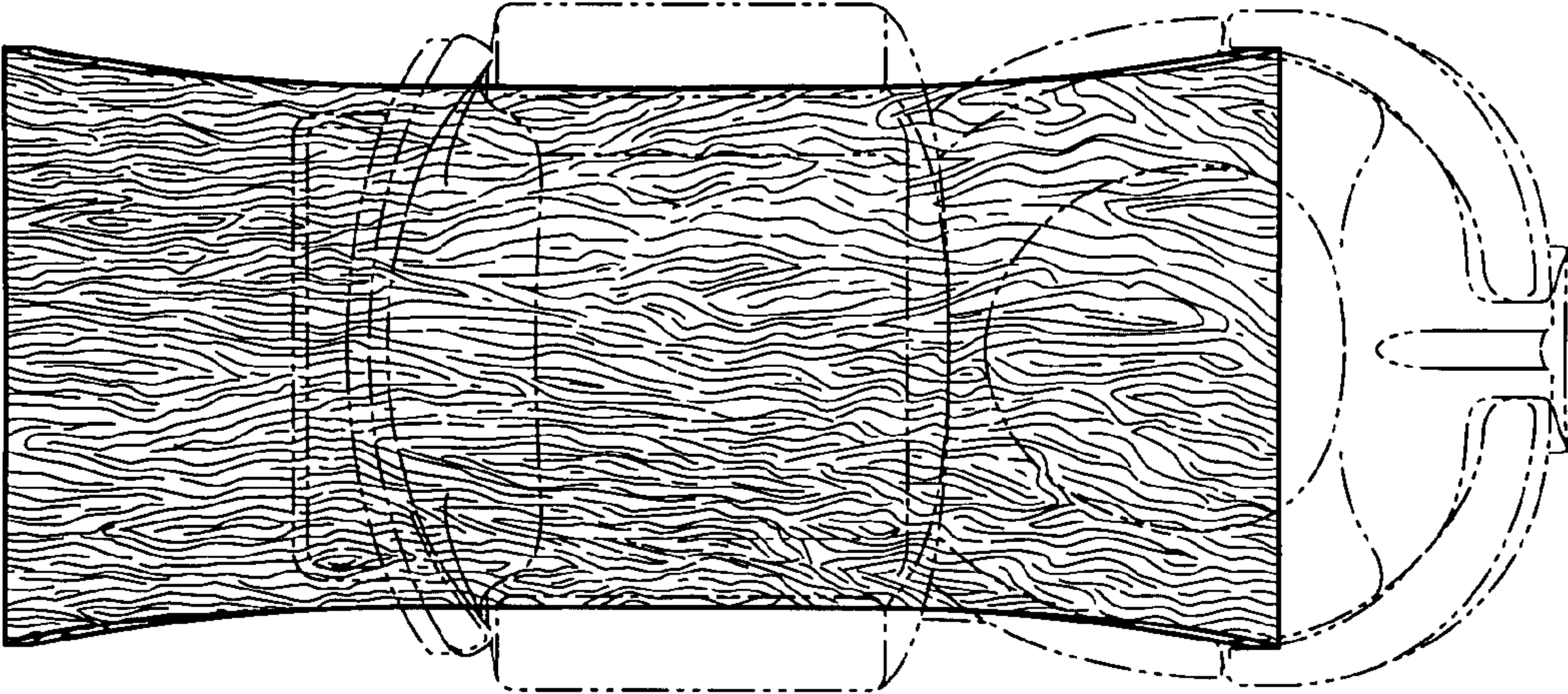

Fig. 4

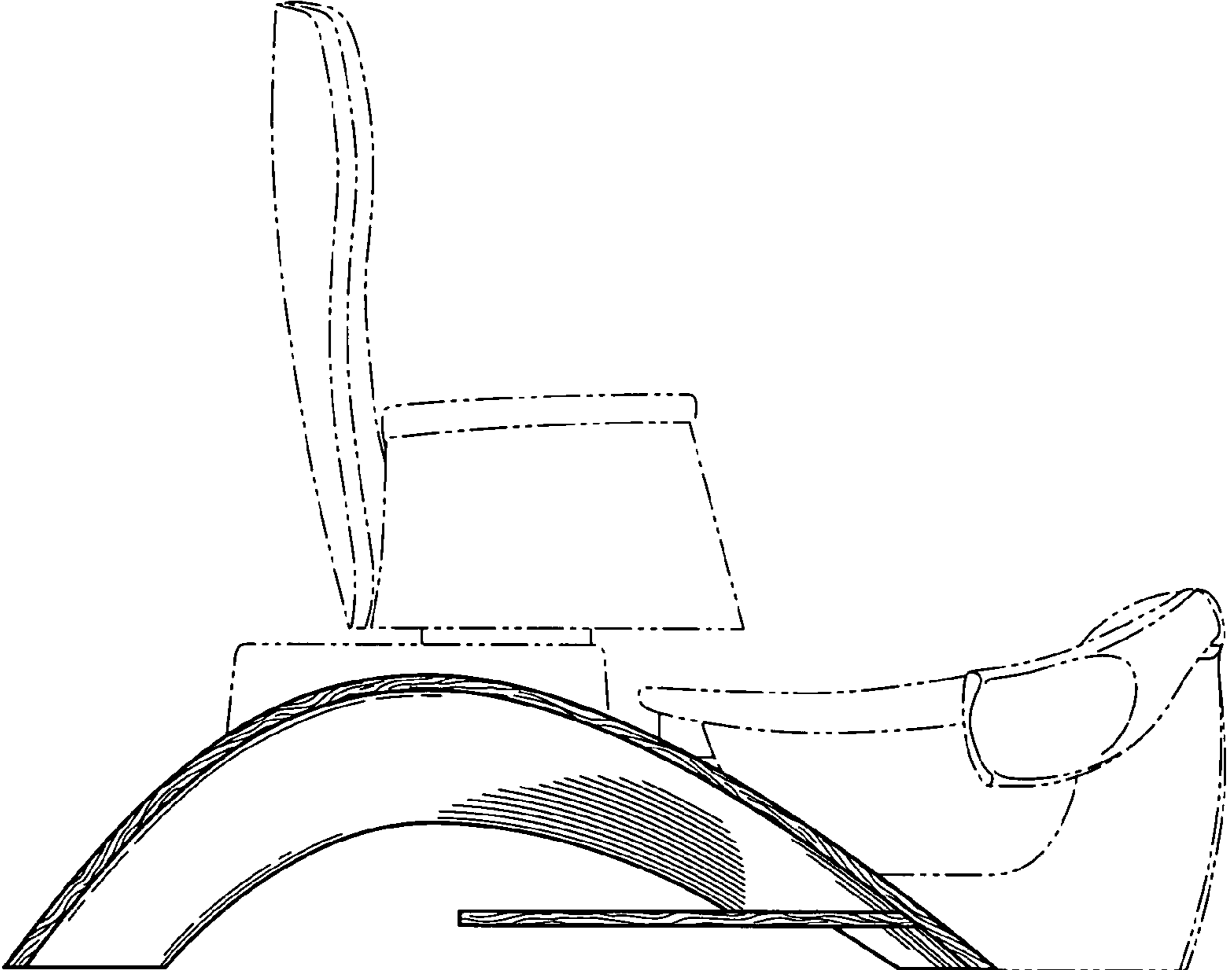

Fig. 5

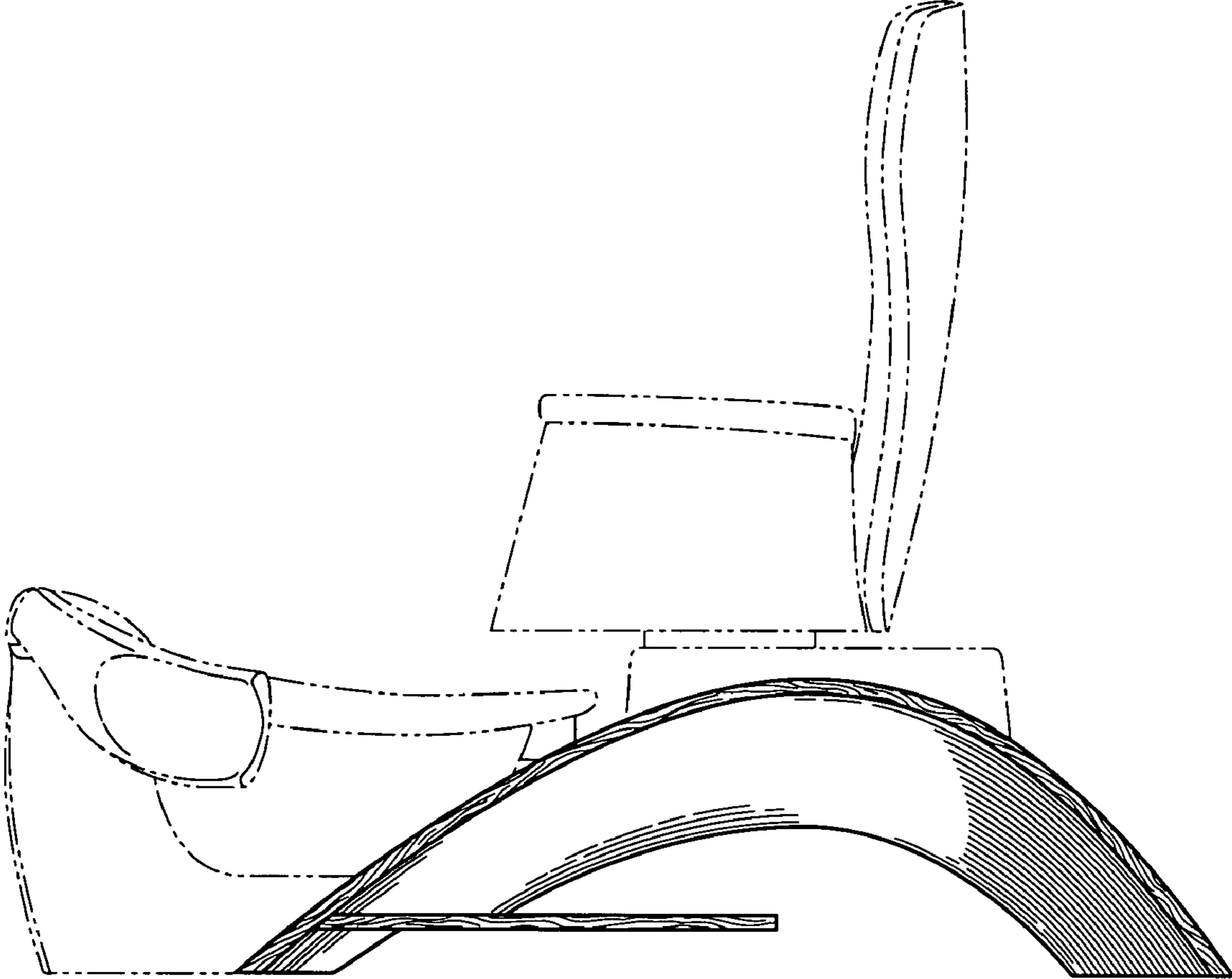

Fig. 6