

US00D569070S

(12) **United States Design Patent**
Oliver

(10) **Patent No.:** **US D569,070 S**

(45) **Date of Patent:** **** May 13, 2008**

(54) **CONVEYOR GUIDE**

D413,420 S * 8/1999 Nimmo et al. D34/29

(75) Inventor: **Peter Brian Oliver**, Tauranga (NZ)

* cited by examiner

(73) Assignee: **Olivator Marketing Limited**, Tauranga (NZ)

Primary Examiner—Cynthia E Ramirez

(74) *Attorney, Agent, or Firm*—Abelman, Frayne & Schwab

(**) Term: **14 Years**

(57) **CLAIM**

(21) Appl. No.: **29/256,500**

The ornamental design of a conveyor guide, as shown and described.

(22) Filed: **Mar. 20, 2006**

(30) **Foreign Application Priority Data**

DESCRIPTION

Sep. 20, 2005 (NZ) 406595

FIG. 1 is a front and top perspective view of the conveyor guide showing the new design in use;

(51) **LOC (8) Cl.** **12-05**

FIG. 2 is a top plan view thereof;

(52) **U.S. Cl.** **D34/29**

FIG. 3 is a bottom plan view thereof;

(58) **Field of Classification Search** D34/29,
D34/35; 198/853, 323, 832.2
See application file for complete search history.

FIG. 4 is a rear elevation view thereof;

FIG. 5 is a front elevation view thereof;

FIG. 6 is a left side view thereof; and,

FIG. 7 is a right side view thereof.

(56) **References Cited**

The broken line in FIG. 1 is for illustrative purposes only and is not part of the claimed design.

U.S. PATENT DOCUMENTS

- 4,770,291 A * 9/1988 Shaw 198/851
- D333,544 S * 2/1993 Uehara D34/29
- D368,567 S * 4/1996 Chase D34/29

1 Claim, 6 Drawing Sheets

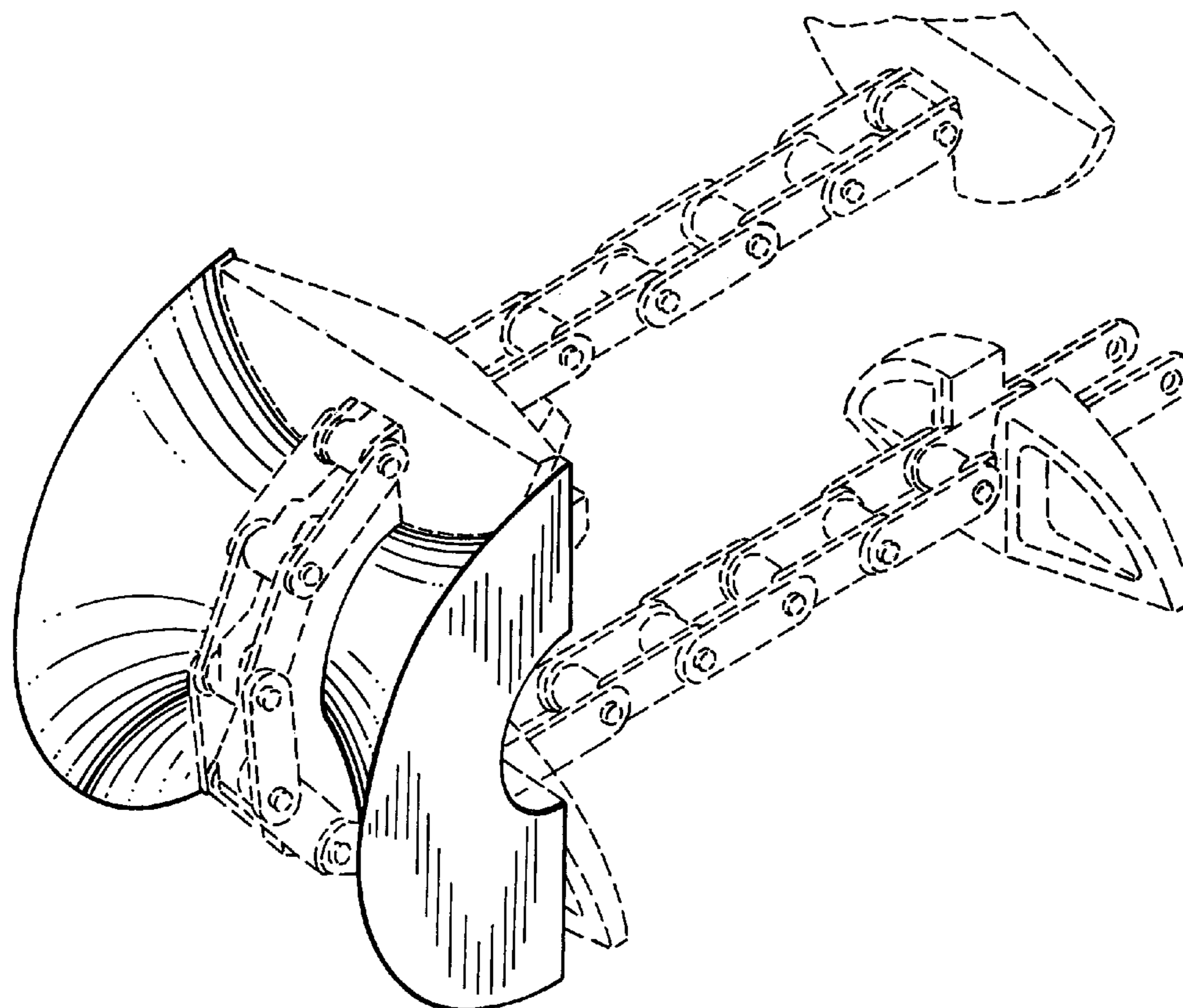

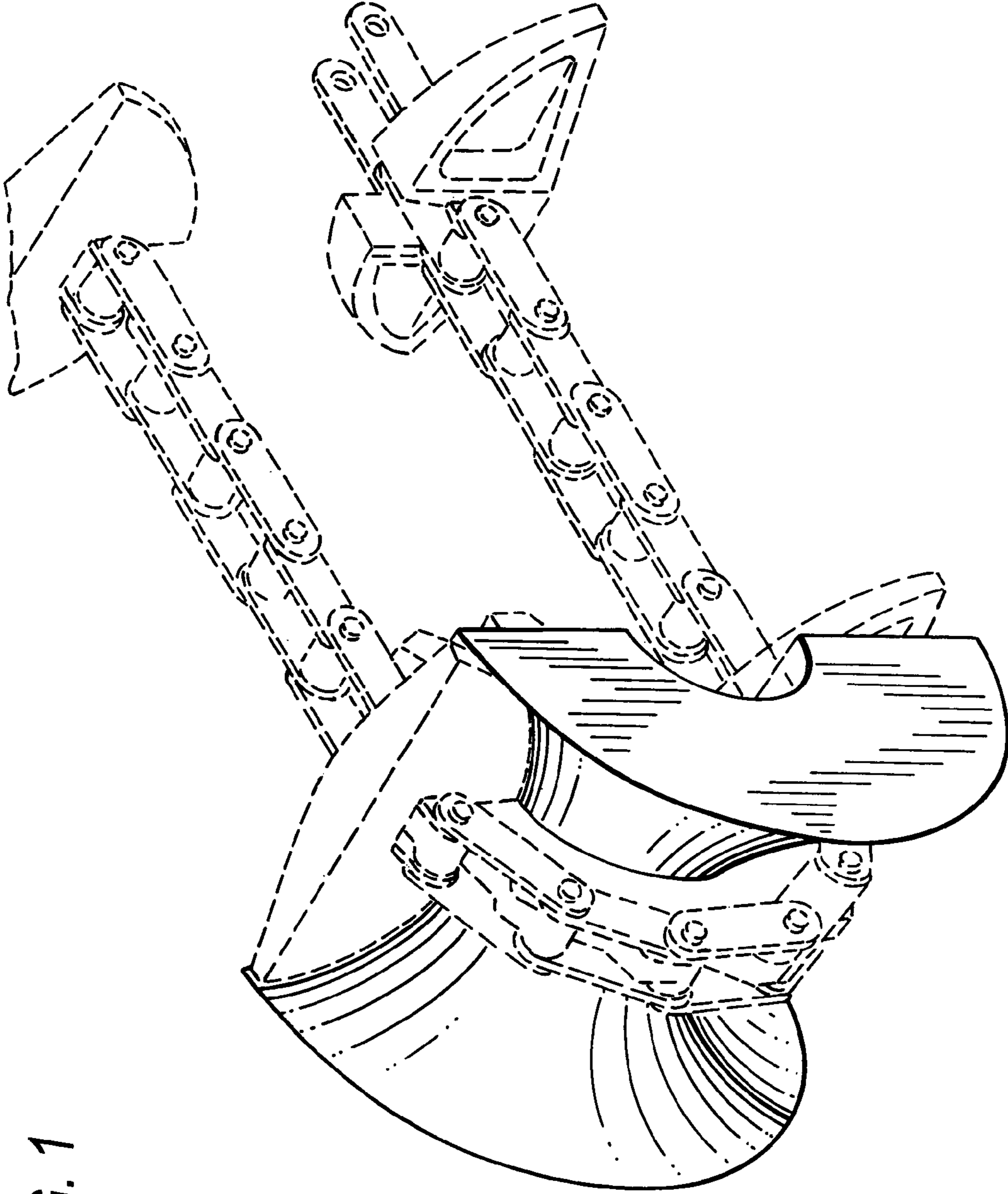

FIG. 1

FIG. 2

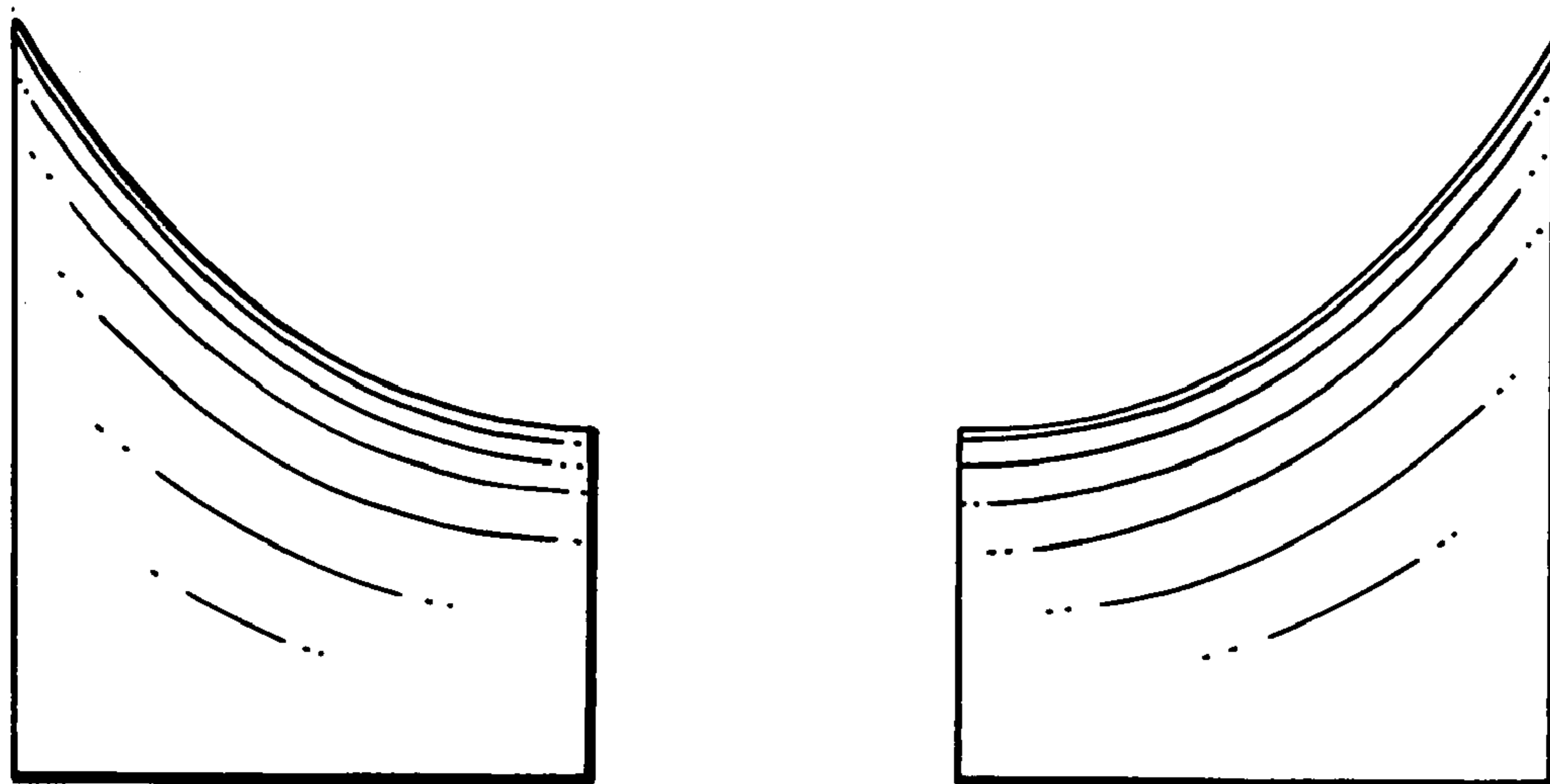
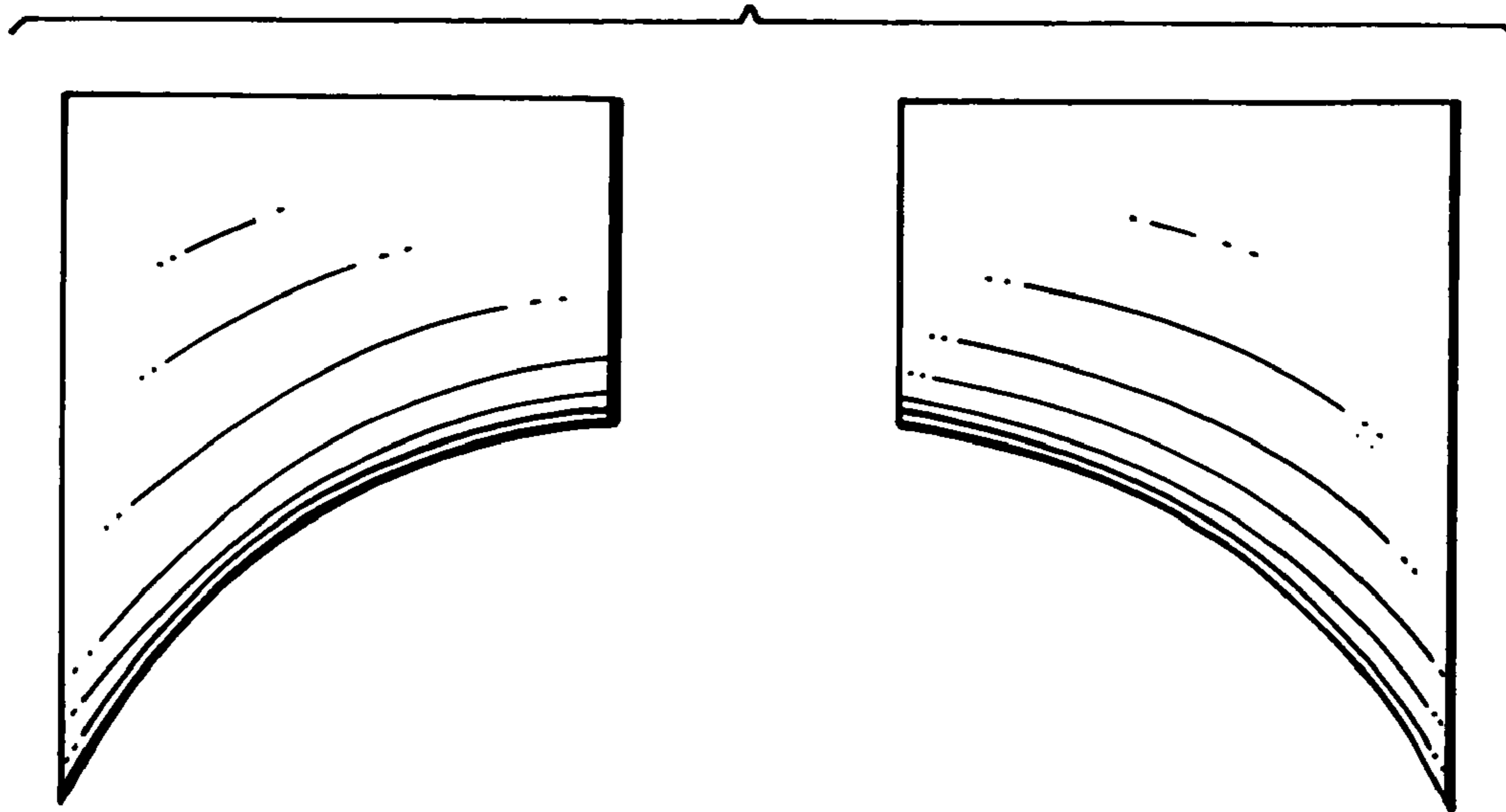

FIG. 3

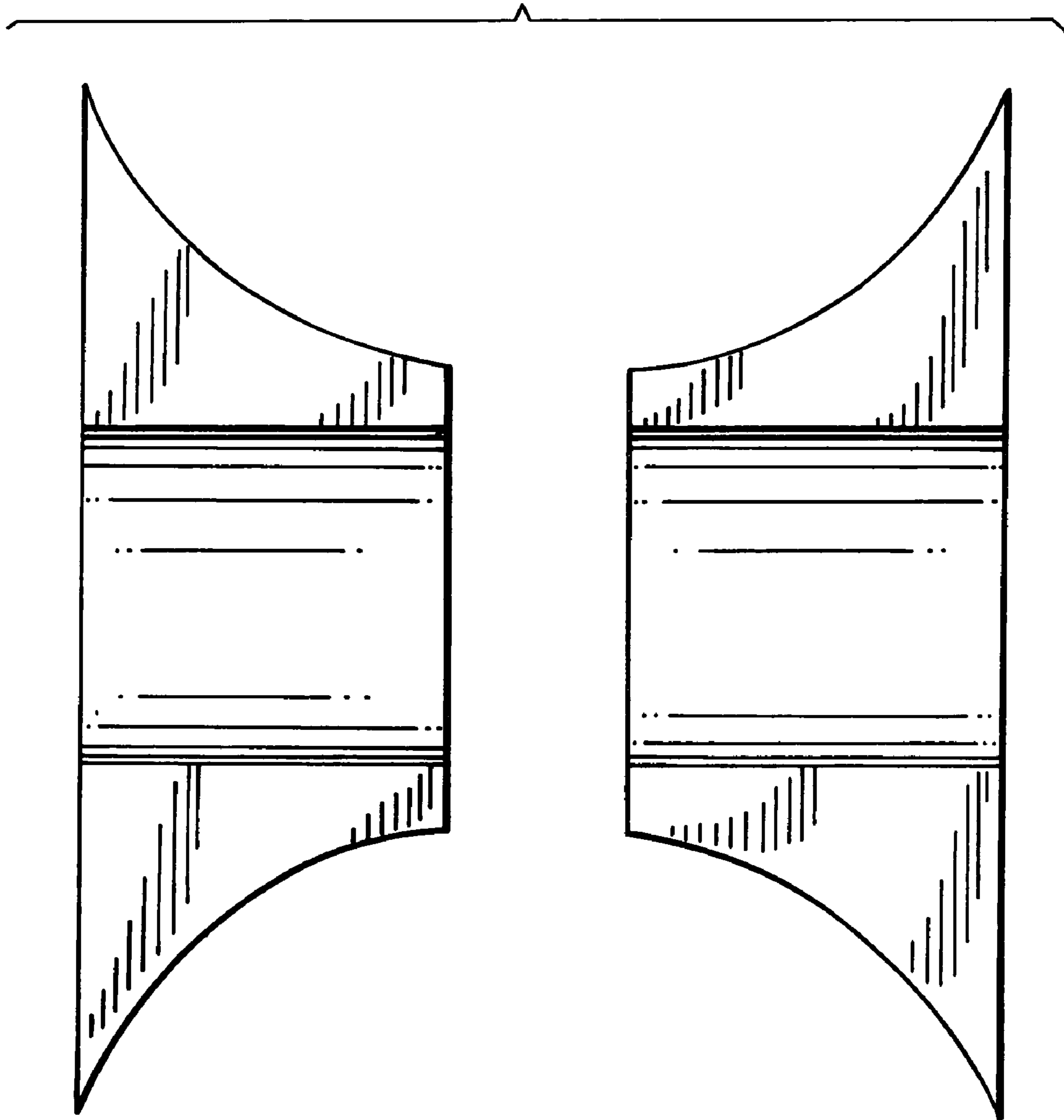

FIG. 4

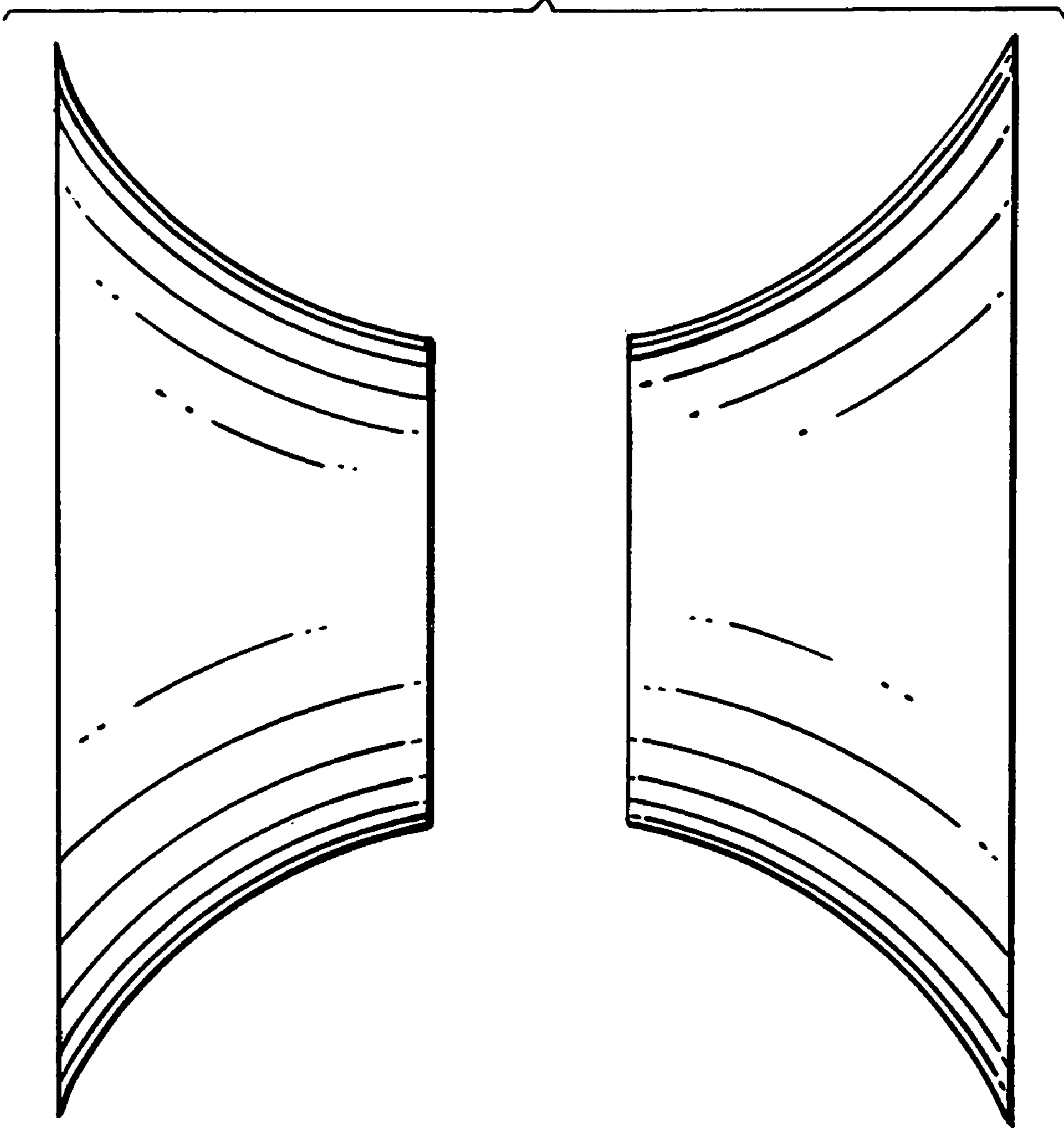

FIG. 5

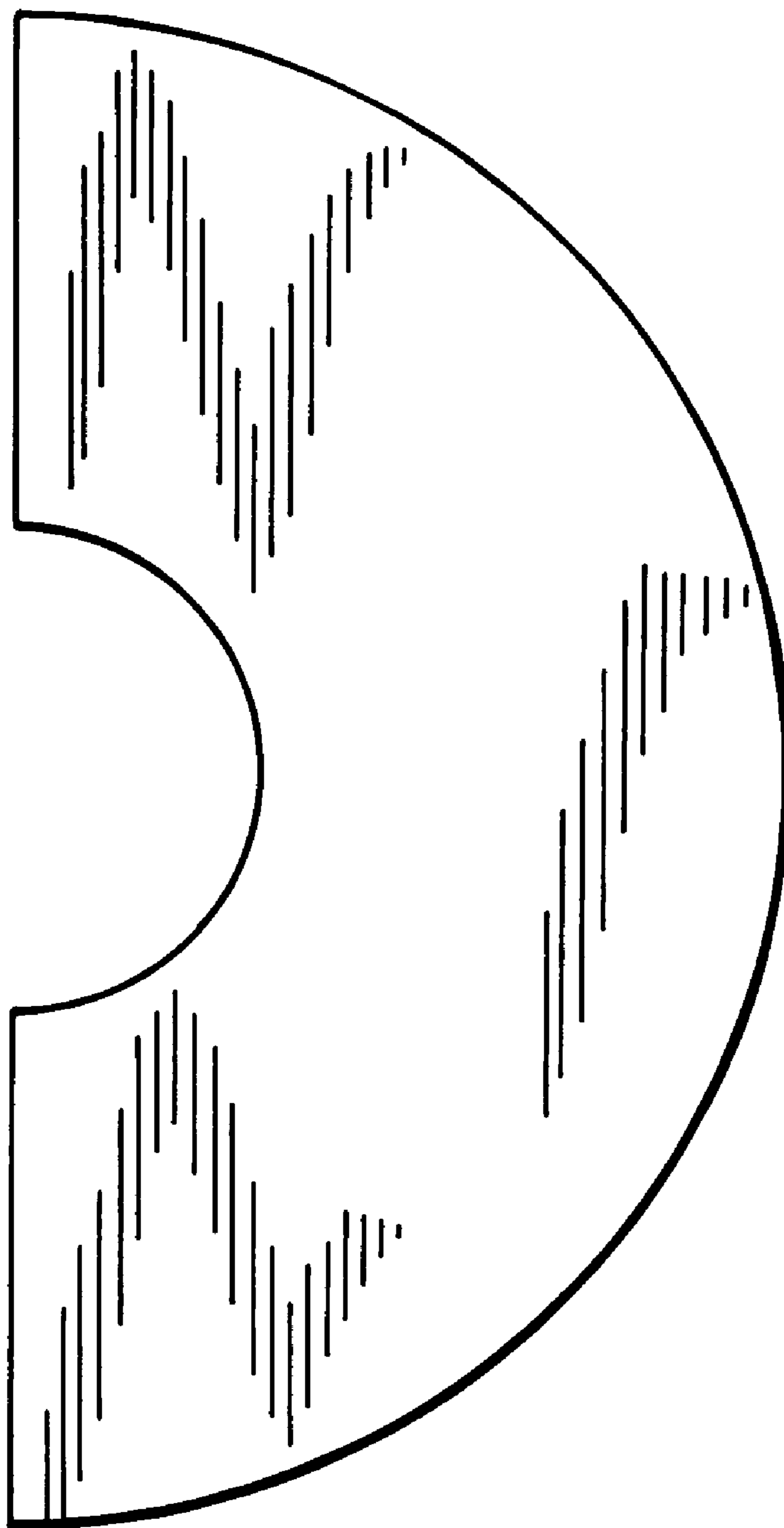

FIG. 6

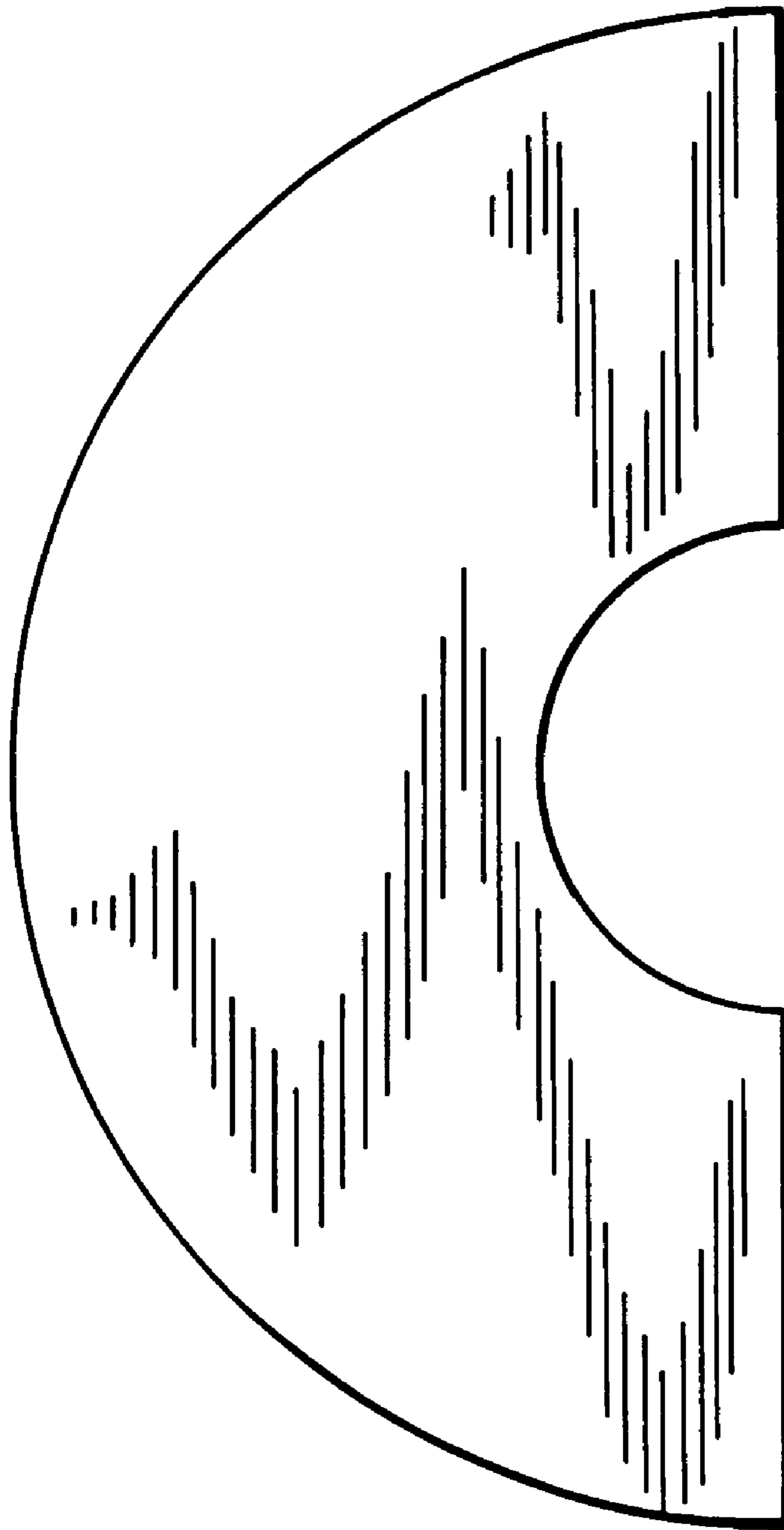

FIG. 7