



US00D569055S

(12) **United States Design Patent** (10) **Patent No.:** **US D569,055 S**
Bochmann et al. (45) **Date of Patent:** **** May 13, 2008**

(54) **CORDLESS BLOWER VACUUM**

(75) Inventors: **Cherry Bochmann**, Bay Village, OH (US); **Erin Riddell**, Bay Village, OH (US)

(73) Assignee: **Desa IP, LLC**, Miami, FL (US)

(**) Term: **14 Years**

(21) Appl. No.: **29/280,564**

(22) Filed: **May 31, 2007**

(51) **LOC (8) Cl.** **15-05**

(52) **U.S. Cl.** **D32/15**

(58) **Field of Classification Search** D32/1,
D32/15-18, 21, 25, 31; 15/344, 345, 405,
15/412, 414, 415.1

See application file for complete search history.

(56) **References Cited**

U.S. PATENT DOCUMENTS

D400,322 S * 10/1998 Webster et al. D32/15
6,442,790 B1 * 9/2002 Svoboda et al. 15/330
D468,874 S * 1/2003 Nawrozki et al. D32/15
D497,692 S * 10/2004 Nawrozki et al. D32/15
D526,750 S * 8/2006 Ito D32/15

OTHER PUBLICATIONS

http://s7.sears.com/is/image/Sears/07179473000?qlt=90,0&resMode=sharp&op_usm+0.9,0.5,0,0 Dec. 20, 2007.*

http://s7.sears.com/is/image/Sears/0717494820000?hei=250&wid=250&op_sharpen=1&qlt=90,0&resMod Dec. 20, 2007.*

http://s7.sears.com/is/image/Sears/07174827000?qlt=90,0&resMode=sharp&op_usm+0.9,0.5,0,0 Dec. 20, 2007.*

* cited by examiner

Primary Examiner—Louis S. Zarfes

Assistant Examiner—Kathleen Sims

(74) *Attorney, Agent, or Firm*—Suiter Swantz pc llo

(57) **CLAIM**

The ornamental design for a cordless blower vacuum, as shown and described.

DESCRIPTION

FIG. 1 is a perspective view of the cordless blower vacuum showing our new design;

FIG. 2 is a left side view thereof;

FIG. 3 is a right side view thereof;

FIG. 4 is a top view thereof;

FIG. 5 is a bottom view thereof;

FIG. 6 is a front view thereof; and,

FIG. 7 is a rear view thereof.

1 Claim, 7 Drawing Sheets

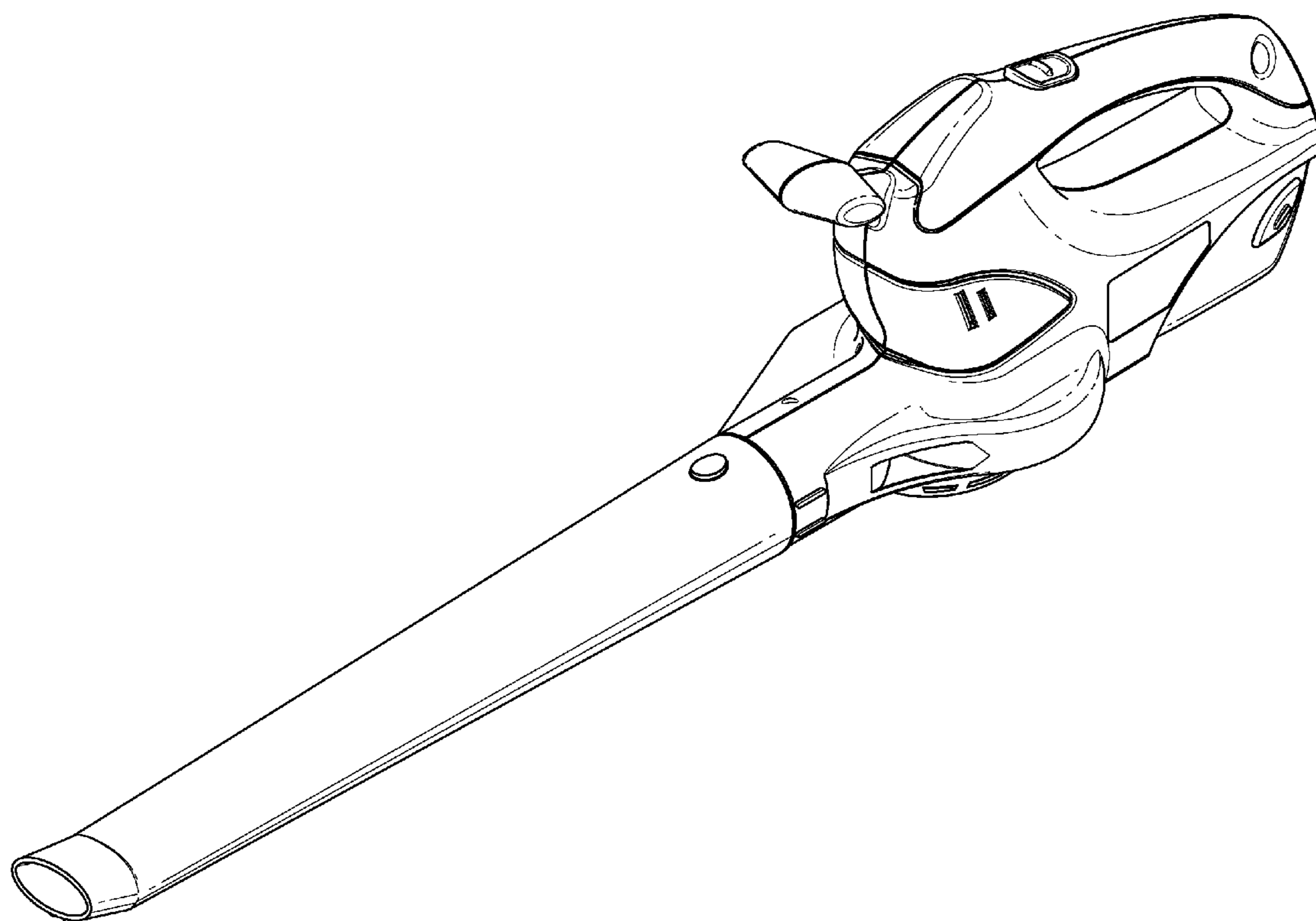

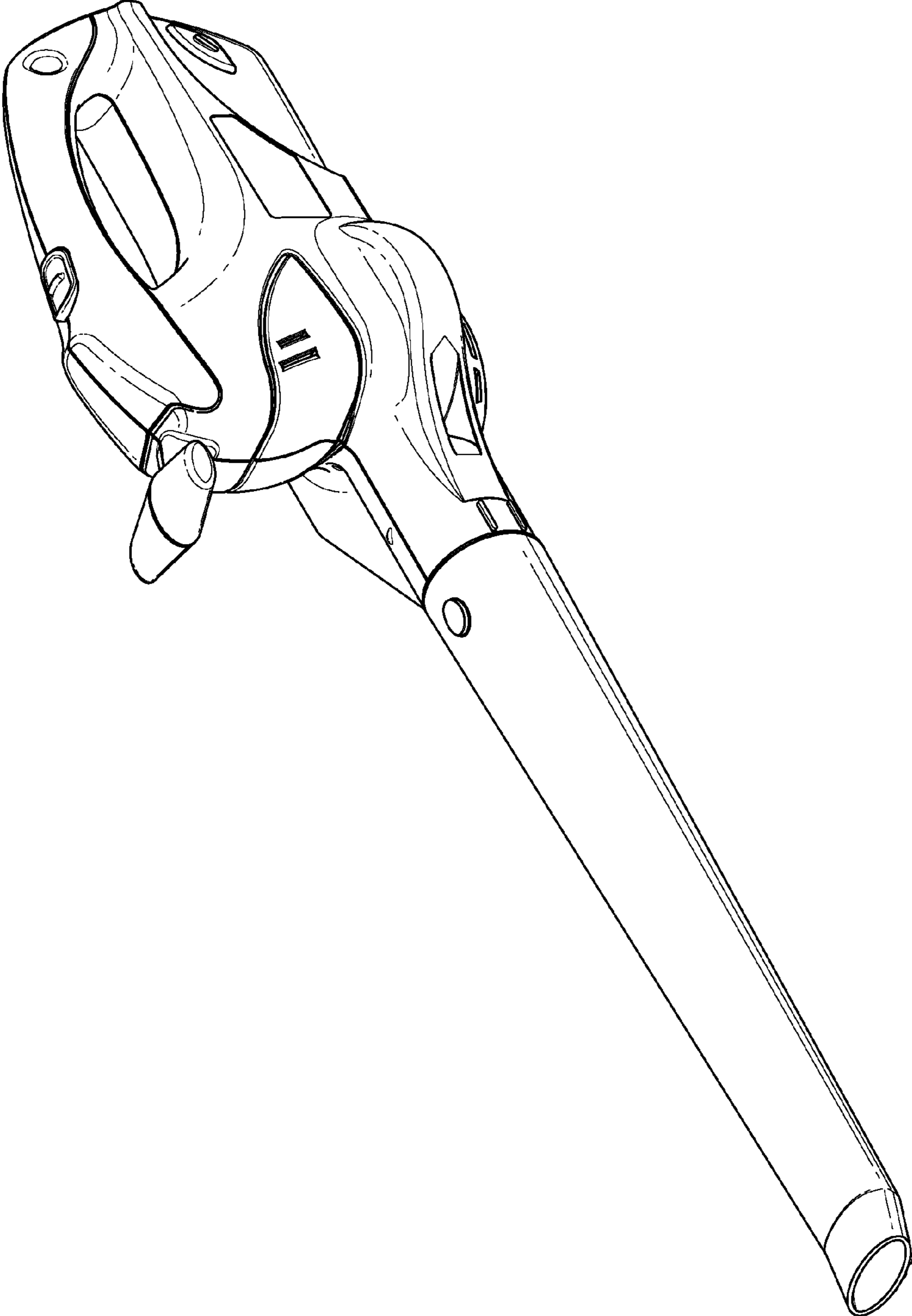

FIG. 1

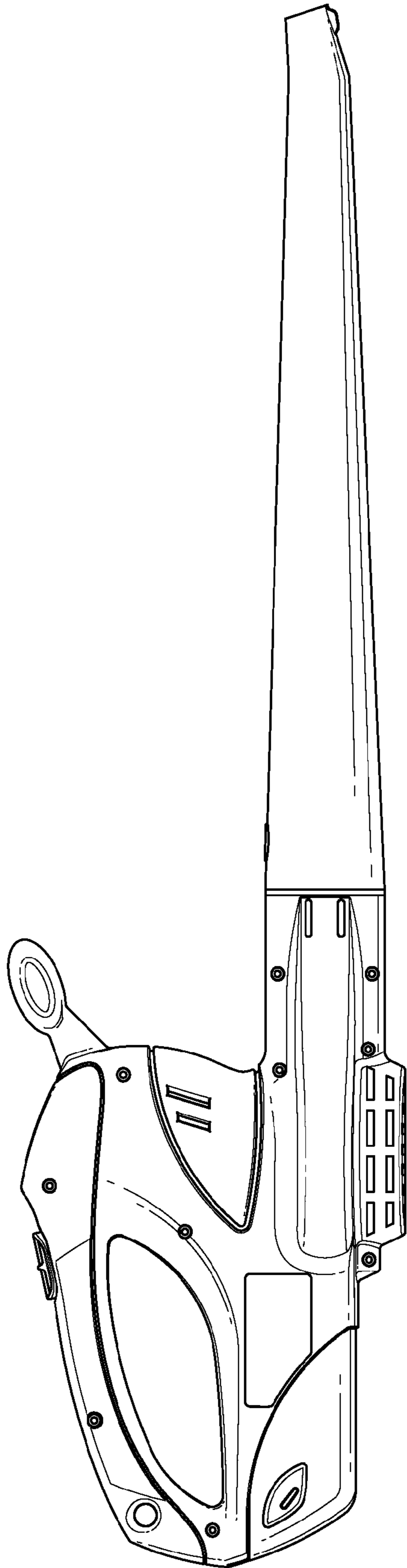

FIG. 2

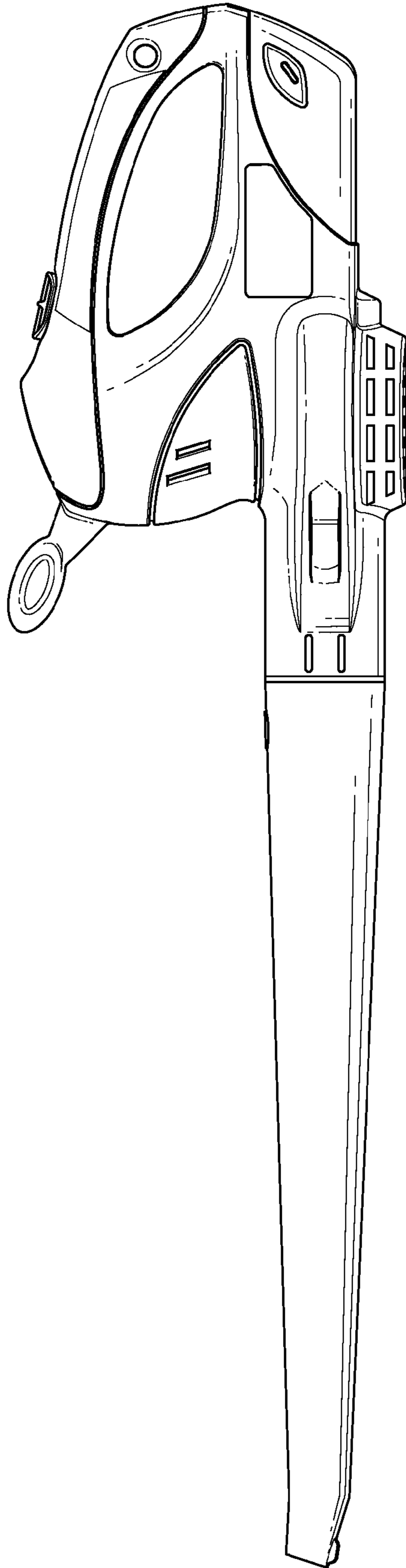

FIG. 3

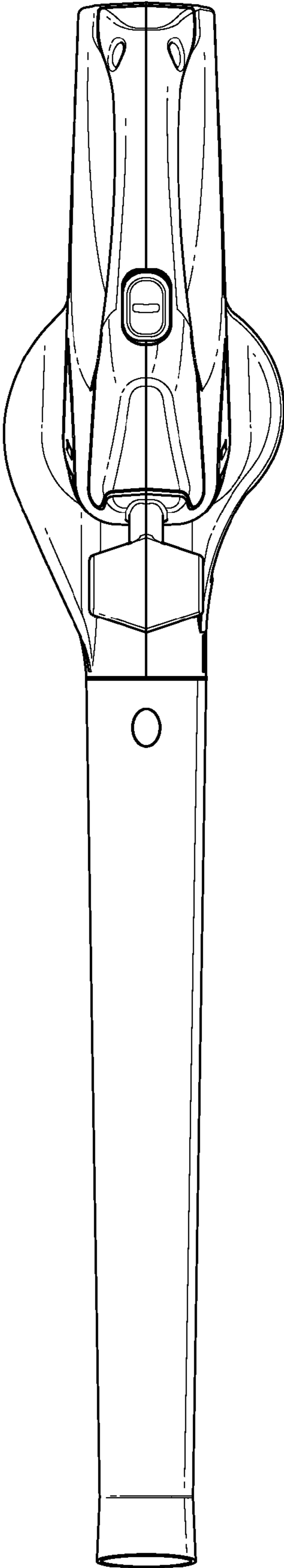

FIG. 4

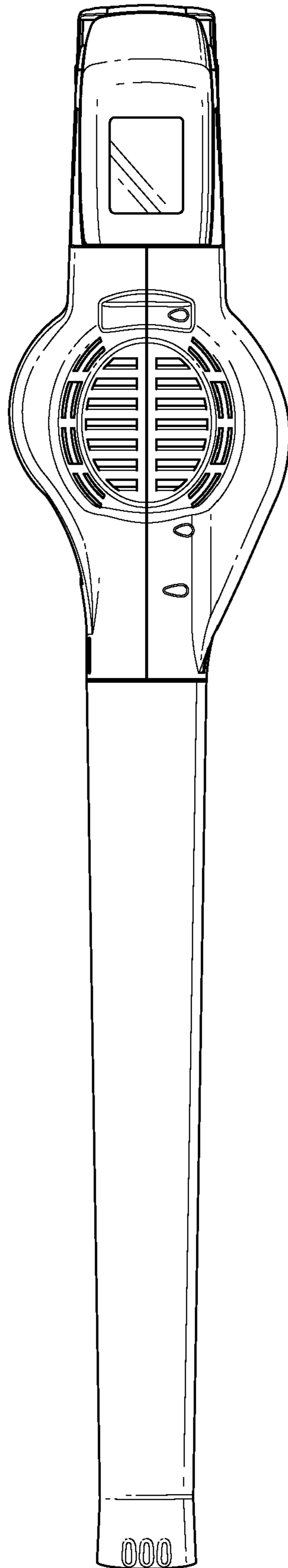

FIG. 5

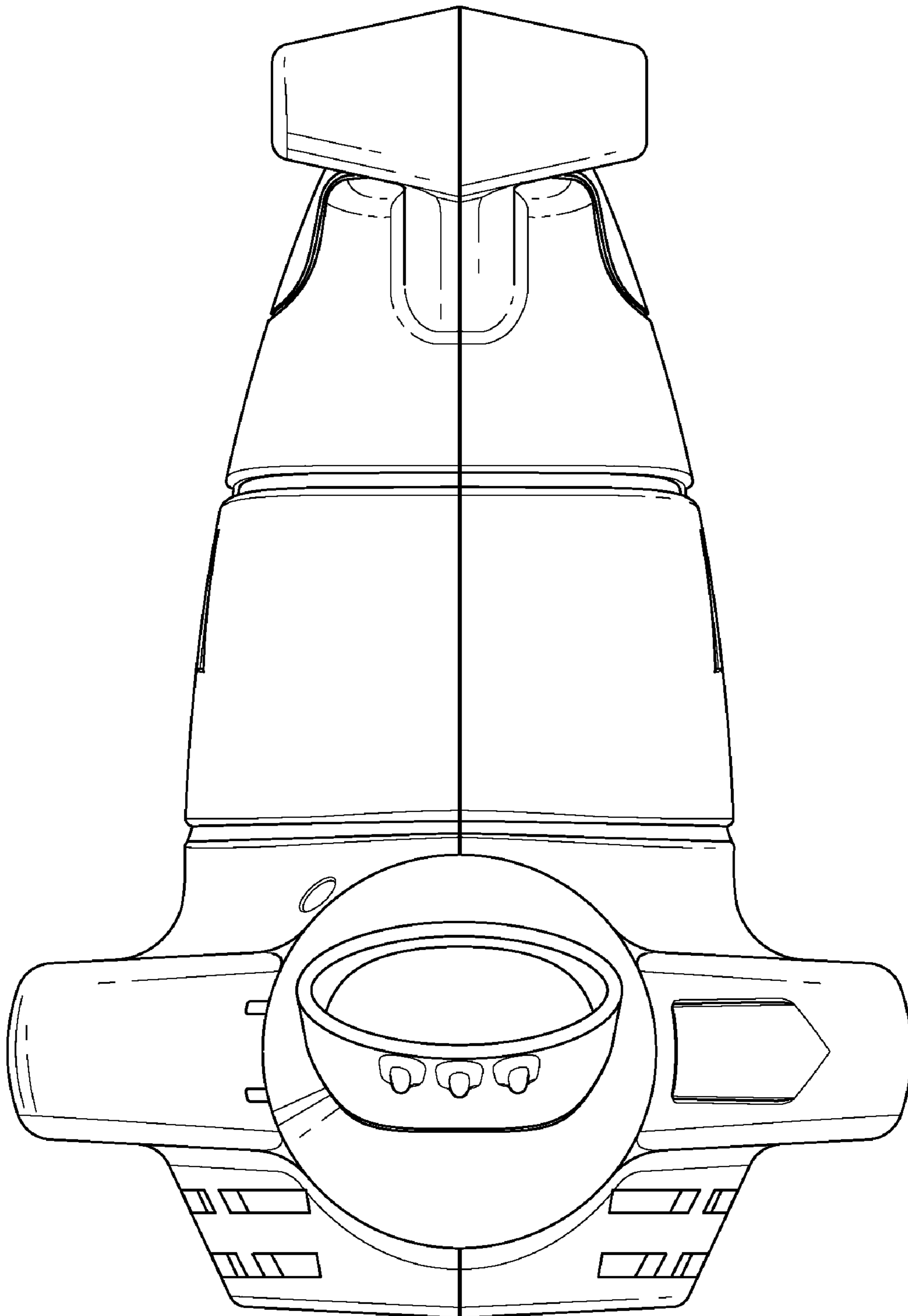

FIG. 6

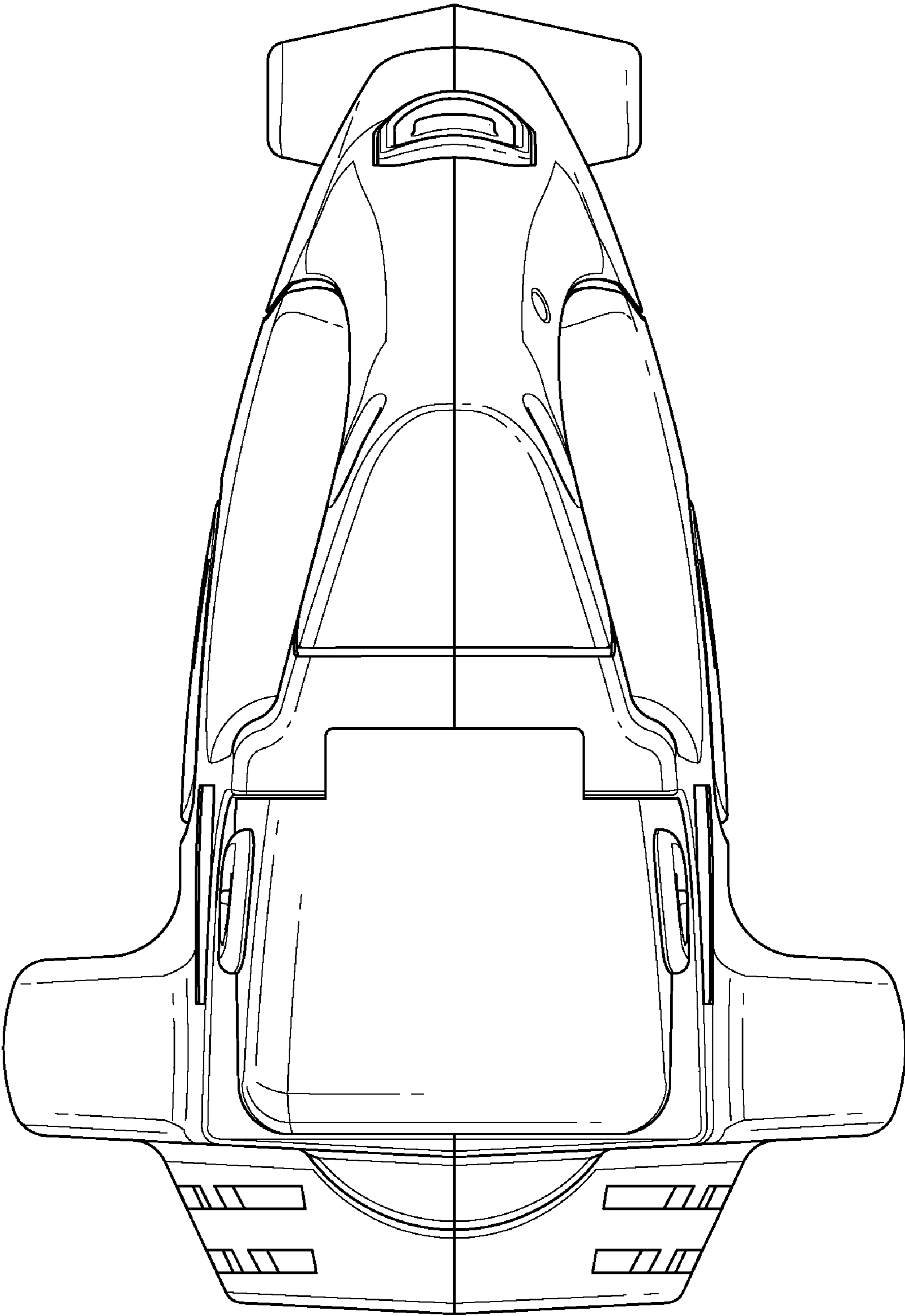

FIG. 7