

US00D568962S

(12) **United States Design Patent**
Nathan et al.

(10) **Patent No.:** **US D568,962 S**

(45) **Date of Patent:** **** May 13, 2008**

(54) **CUP PAINT GUN**

(75) Inventors: **Philip Nathan**, West Hartford, CT (US); **Robert H. Bruno**, Avon, CT (US)

(73) Assignee: **Wagner Spray Tech Corporation**, Plymouth, MN (US)

(**) Term: **14 Years**

(21) Appl. No.: **29/247,116**

(22) Filed: **May 31, 2006**

(51) **LOC (8) Cl.** **23-01**

(52) **U.S. Cl.** **D23/225**

(58) **Field of Classification Search** D23/213,
D23/225; 417/411; 222/333; 239/337,
239/DIG. 14

See application file for complete search history.

(56) **References Cited**

U.S. PATENT DOCUMENTS

- D286,426 S * 10/1986 Lin D23/225
- D307,463 S * 4/1990 Fushiya et al. D23/225
- 6,631,855 B2 10/2003 Huang
- D490,500 S * 5/2004 Ye et al. D23/225

- 6,805,306 B1 10/2004 Huang
- D503,213 S * 3/2005 Stevens et al. D23/225
- D503,215 S * 3/2005 Stevens et al. D23/225

* cited by examiner

Primary Examiner—Robin V Webster

(74) *Attorney, Agent, or Firm*—Faegre & Benson LLP

(57) **CLAIM**

The ornamental design for a cup paint gun, as shown.

DESCRIPTION

FIG. 1 is a perspective view of a first embodiment a cup paint gun of the present invention.

FIG. 2 is a left side view of the cup paint gun of FIG. 1.

FIG. 3 is a right side view of the cup paint gun of FIG. 1.

FIG. 4 is a front view of the cup paint gun of FIG. 1.

FIG. 5 is a rear view of the cup paint gun of FIG. 1.

FIG. 6 is a top view of the cup paint gun of FIG. 1; and,

FIG. 7 is a bottom view of the cup paint gun of FIG. 1.

The broken line showing of the power cord is included for the purpose of illustrating portions of the paint gun and forms no part of the claimed design.

1 Claim, 7 Drawing Sheets

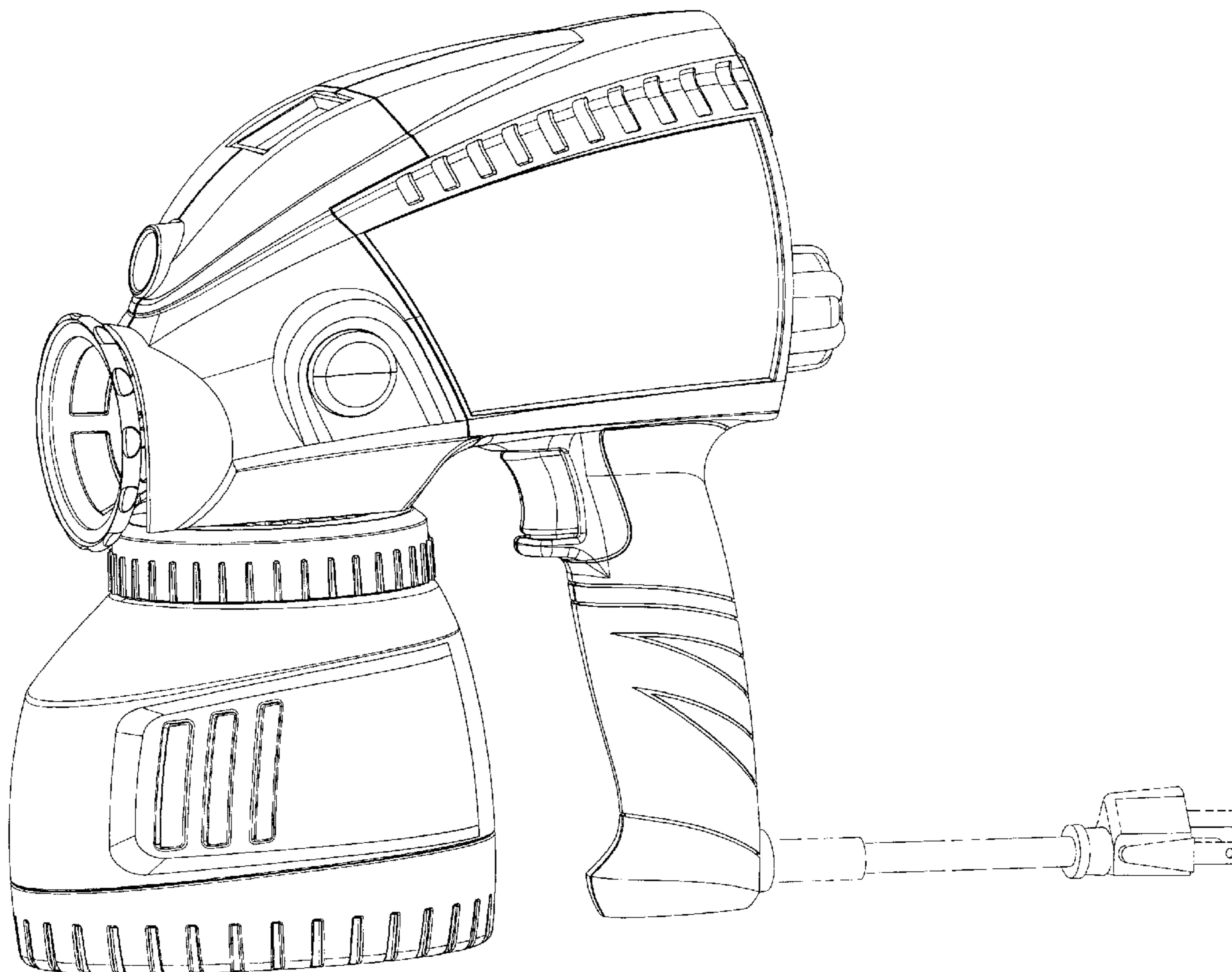

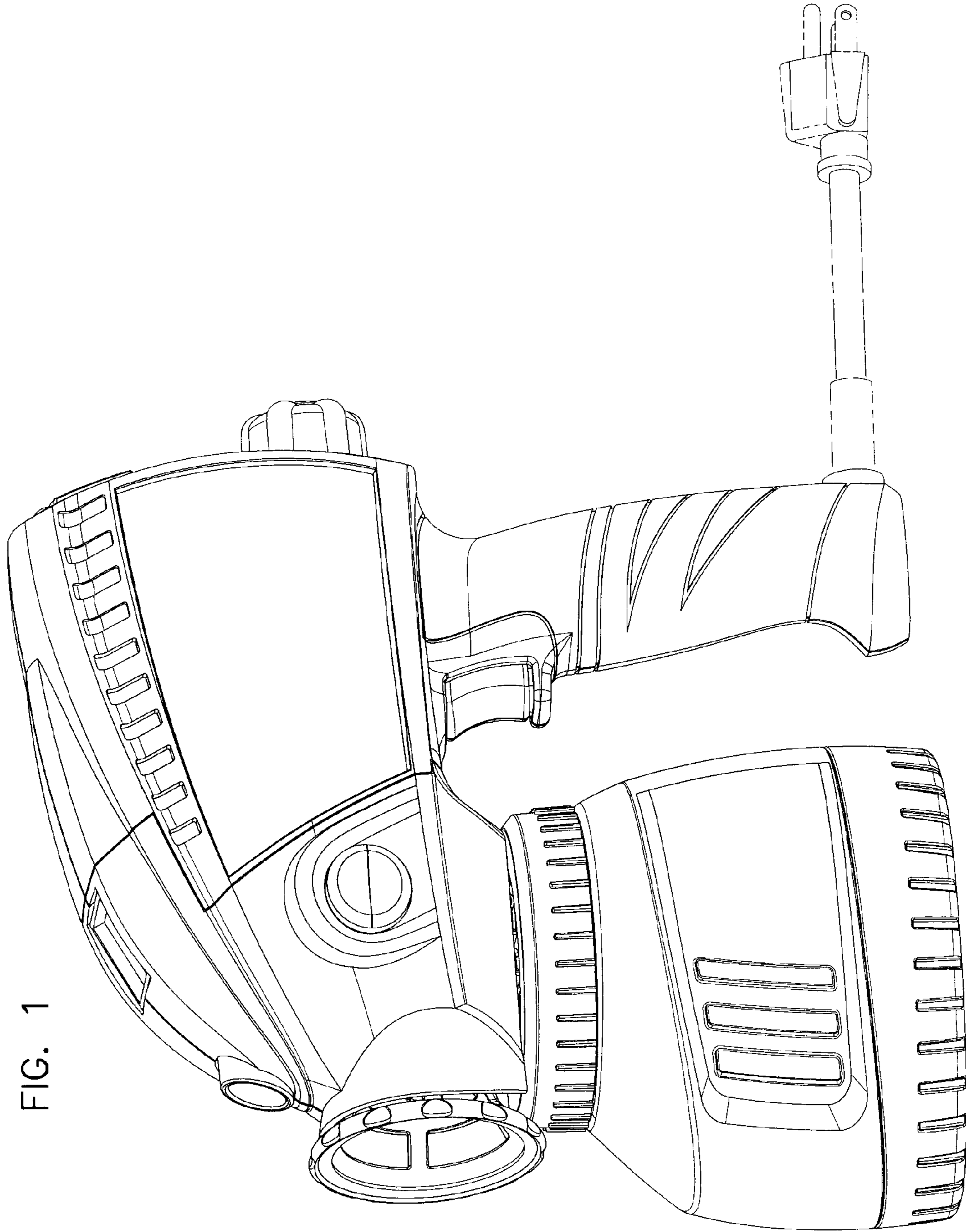

FIG. 1

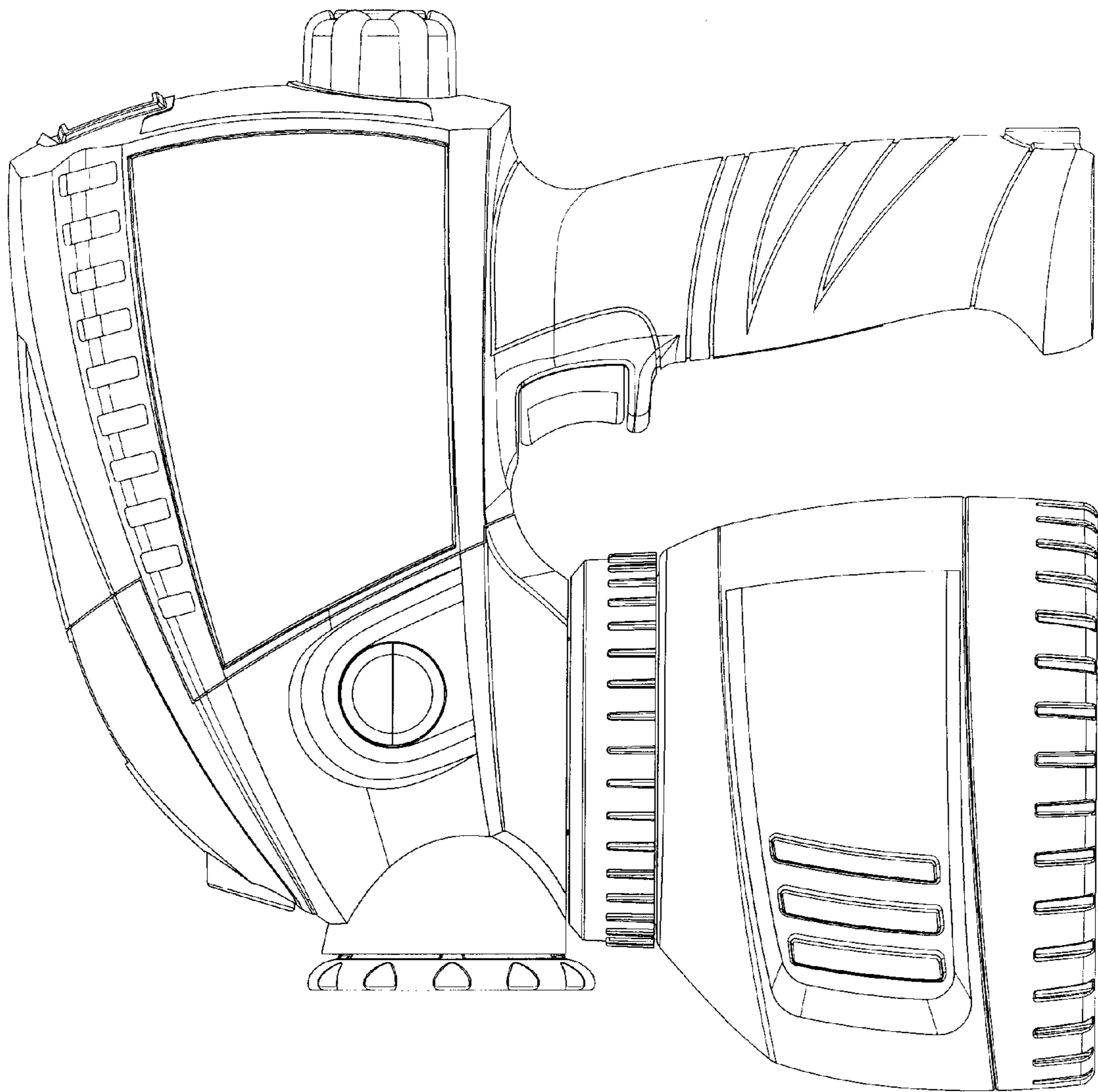

FIG. 2

FIG. 3

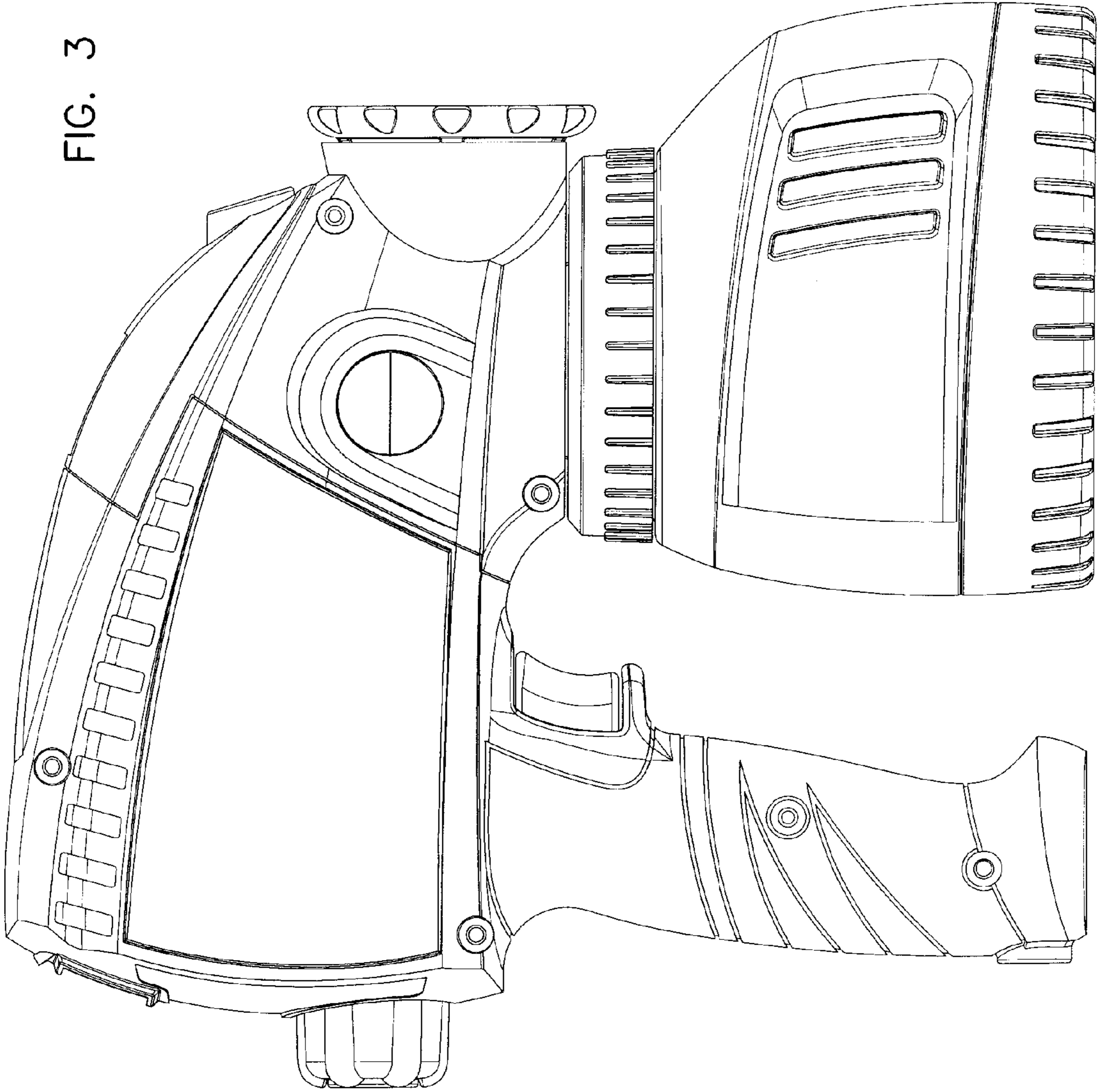

FIG. 4

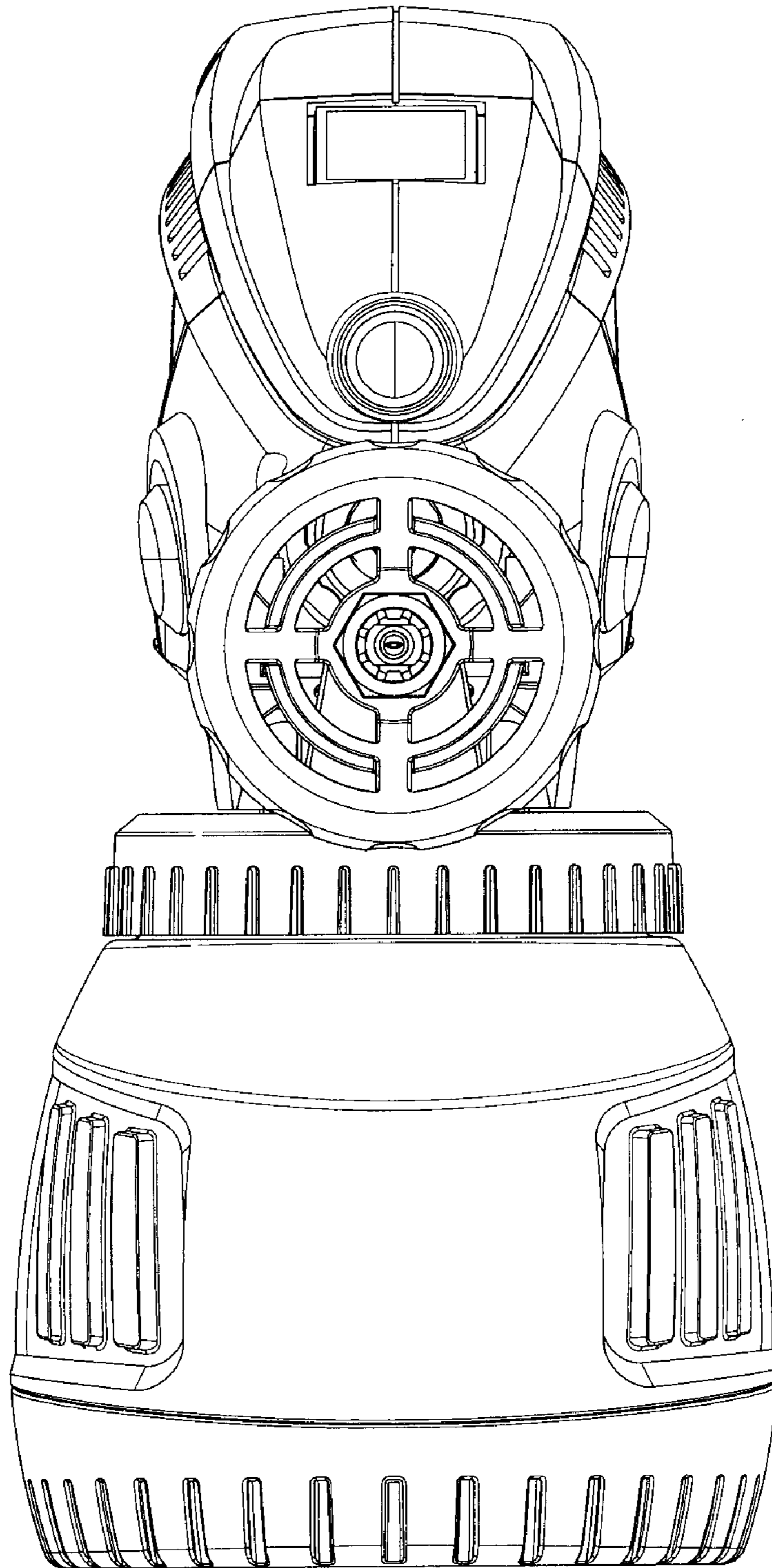

FIG. 5

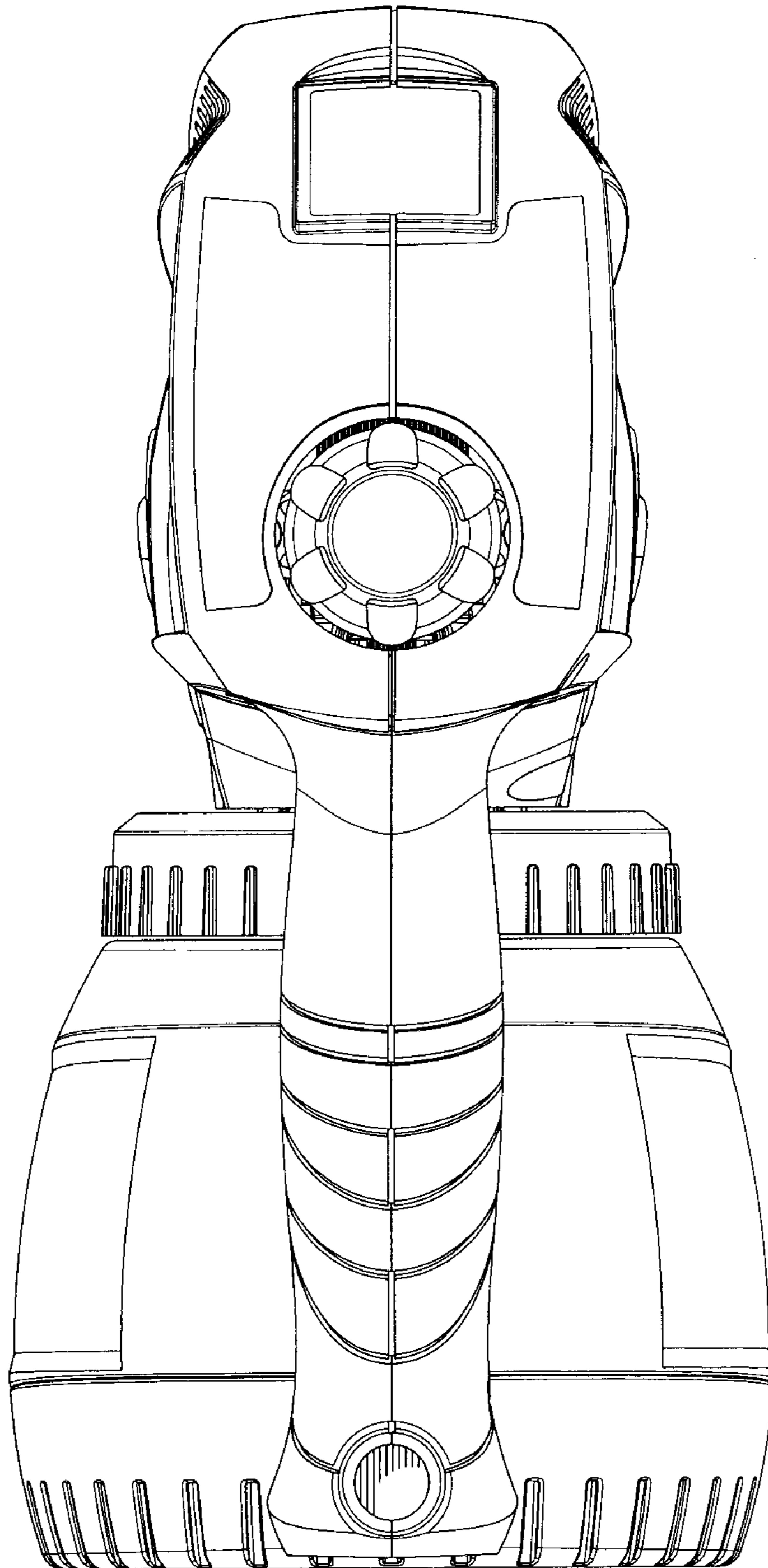

FIG. 6

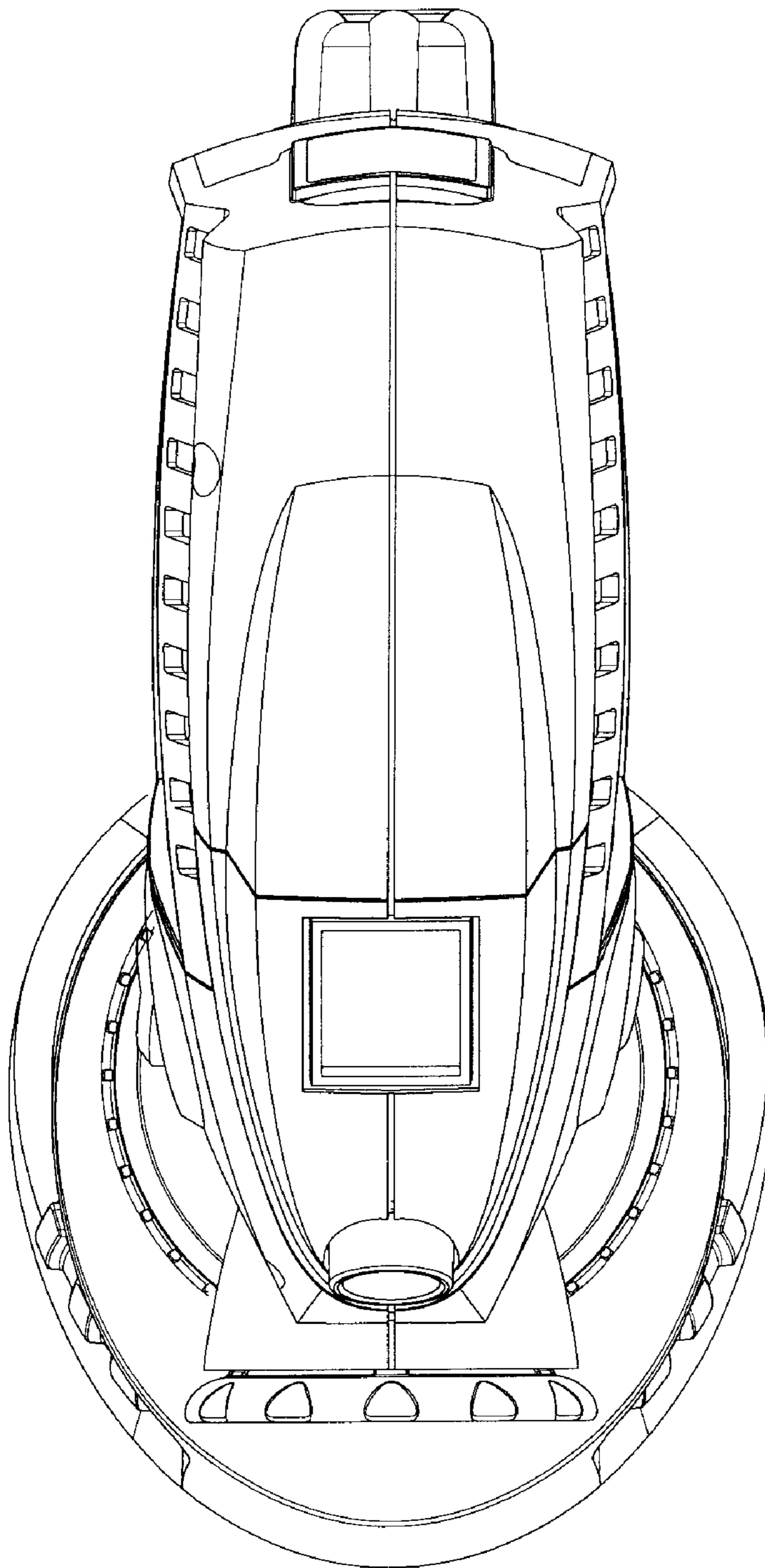

FIG. 7

