



US00D568891S

(12) **United States Design Patent**  
**Morris et al.**

(10) **Patent No.:** **US D568,891 S**  
(45) **Date of Patent:** **\*\* May 13, 2008**

(54) **BOTTOM PORTION HOUSING OF A MOBILE DEVICE**

(75) Inventors: **Quintin Morris**, Brooklyn, NY (US);  
**Katrika Woodcock**, Brooklyn, NY (US); **Jorg Schlieffers**,  
Streatley-on-Thames (GB); **Chris Crawford**, Glen Cove, NY (US)

(73) Assignee: **Symbol Technologies, Inc.**, Holtsville, NY (US)

(\*\*) Term: **14 Years**

(21) Appl. No.: **29/254,371**

(22) Filed: **Feb. 21, 2006**

(51) **LOC (8) Cl.** ..... **14-02**

(52) **U.S. Cl.** ..... **D14/453**

(58) **Field of Classification Search** ..... D14/420,  
D14/426-430, 453, 346, 341, 347, 412; D13/107,  
D13/184; 358/473; 235/462.43, 462.45,  
235/462.47, 462.48, 462.44, 462.46, 487,  
235/472.01, 472.02; 16/110.1, 430, 431;  
439/133, 135; 709/219, 201; 710/73; 320/114,  
320/115, 123; 361/679; 382/313, 321; 455/575.1,  
455/561, 572

See application file for complete search history.

(56) **References Cited**

**U.S. PATENT DOCUMENTS**

D414,470 S \* 9/1999 Chacon et al. .... D14/341

D439,898 S \* 4/2001 Ober et al. .... D14/347  
D458,264 S \* 6/2002 MacGregor ..... D14/426  
D473,872 S \* 4/2003 Ausems et al. .... D14/420  
6,832,729 B1 \* 12/2004 Perry et al. .... 235/472.01  
2002/0193082 A1 \* 12/2002 Uemura et al. .... 455/90

\* cited by examiner

*Primary Examiner*—Melanie Tung

*Assistant Examiner*—Susan Moon Lee

(74) *Attorney, Agent, or Firm*—Fay Kaplun & Marcin, LLP

(57) **CLAIM**

The ornamental design for a bottom portion housing of a mobile device, as shown and described.

**DESCRIPTION**

FIG. 1 is a front view of a bottom portion housing of a mobile device showing our new design;

FIG. 2 is a rear view thereof;

FIG. 3 is a top plan view thereof;

FIG. 4 is a bottom view thereof;

FIG. 5 is a first side view thereof;

FIG. 6 is an opposite side view thereof; and,

FIG. 7 is a side-bottom-front perspective view thereof.

The portions rendered in broken line are not claimed.

**1 Claim, 5 Drawing Sheets**

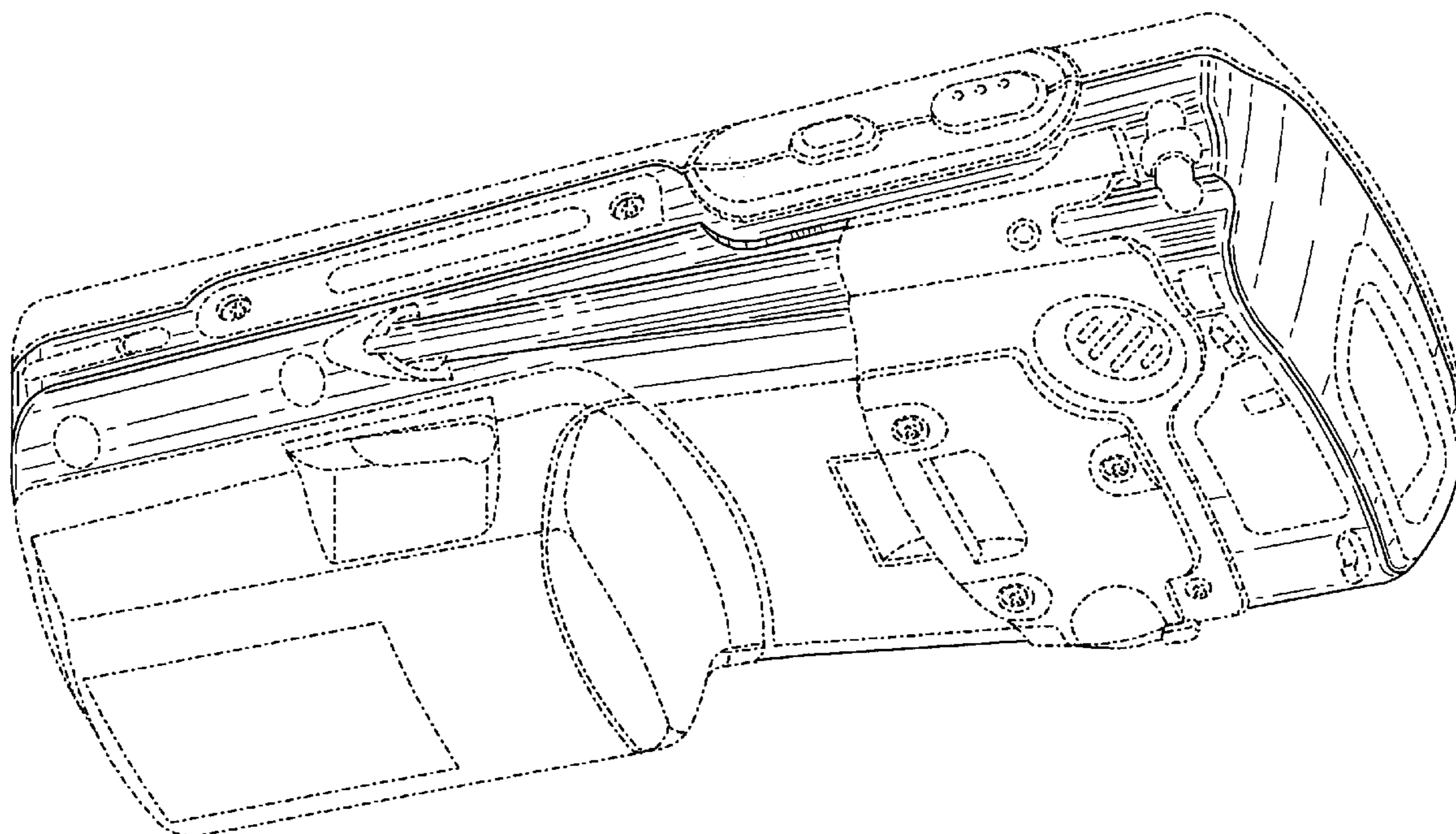

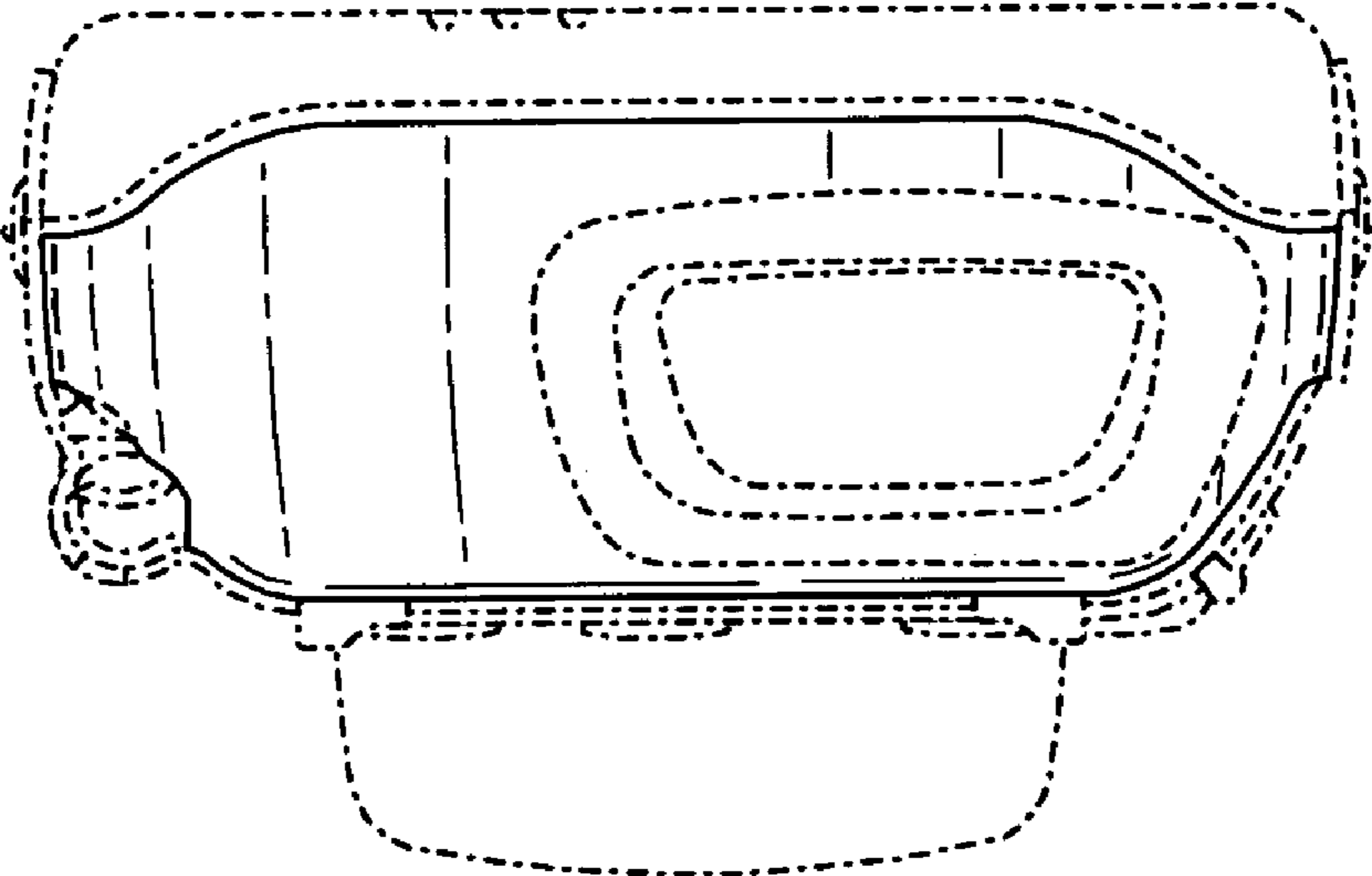

FIG. 1

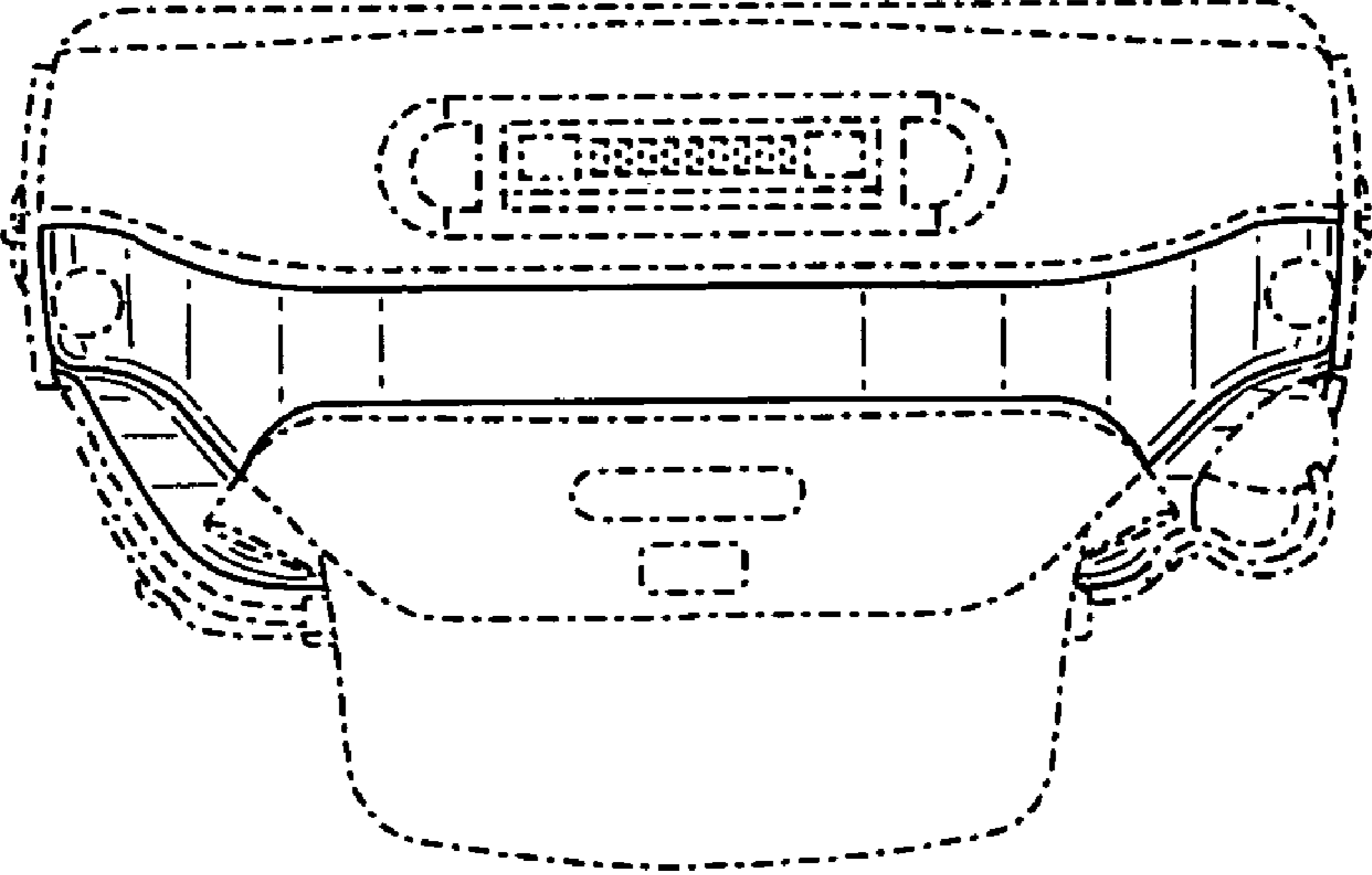

FIG. 2

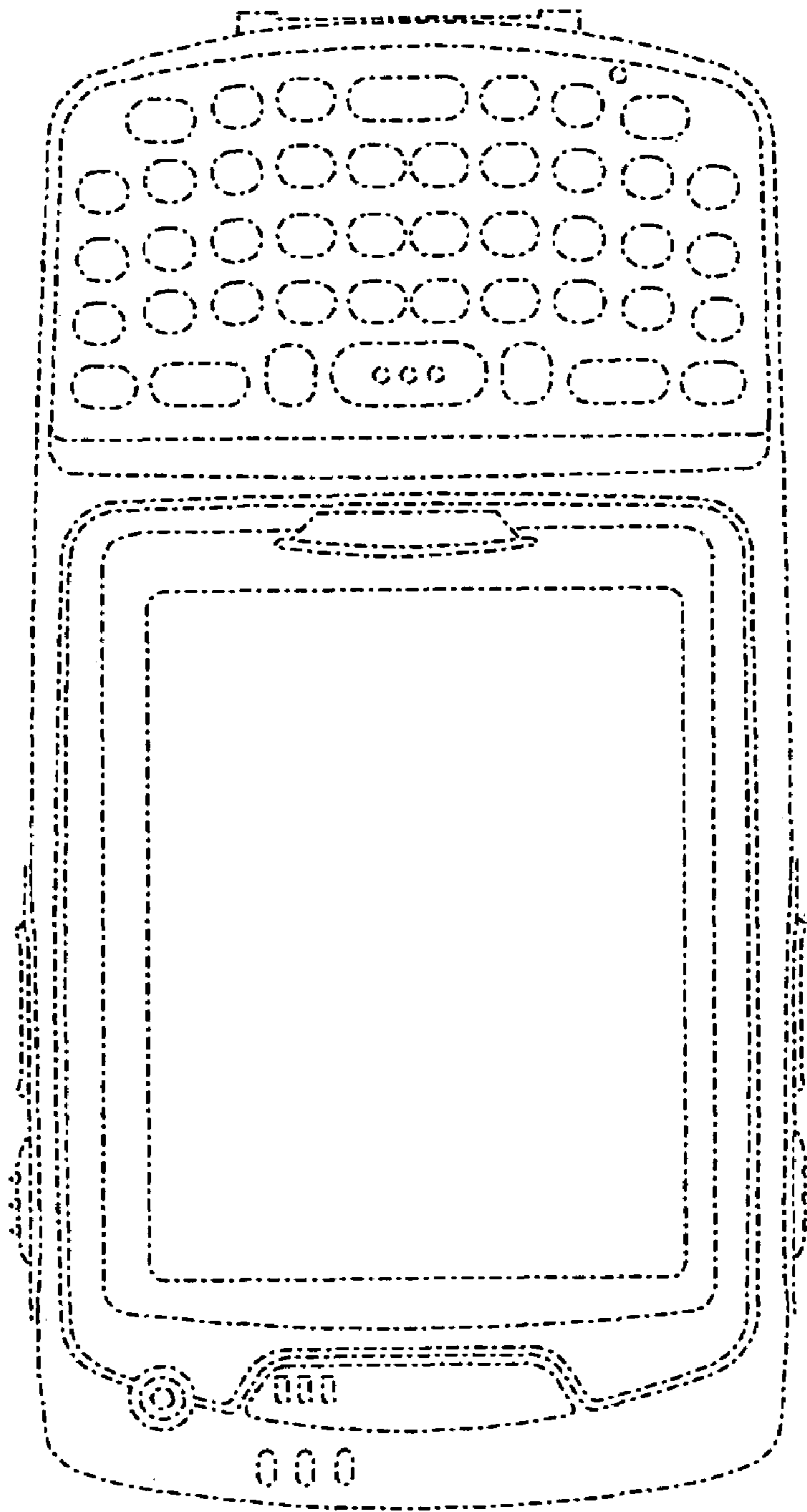

FIG. 3

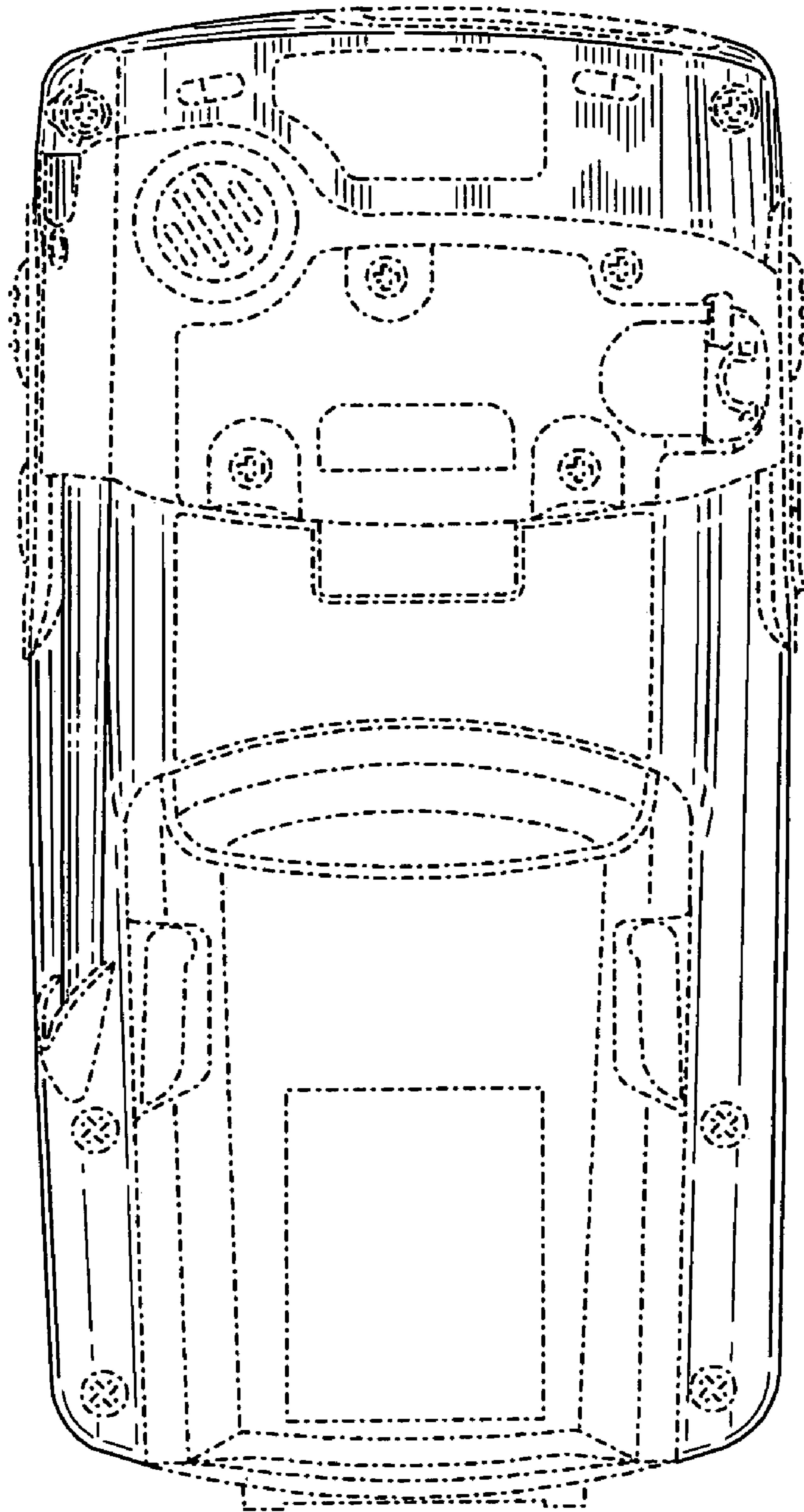

FIG. 4

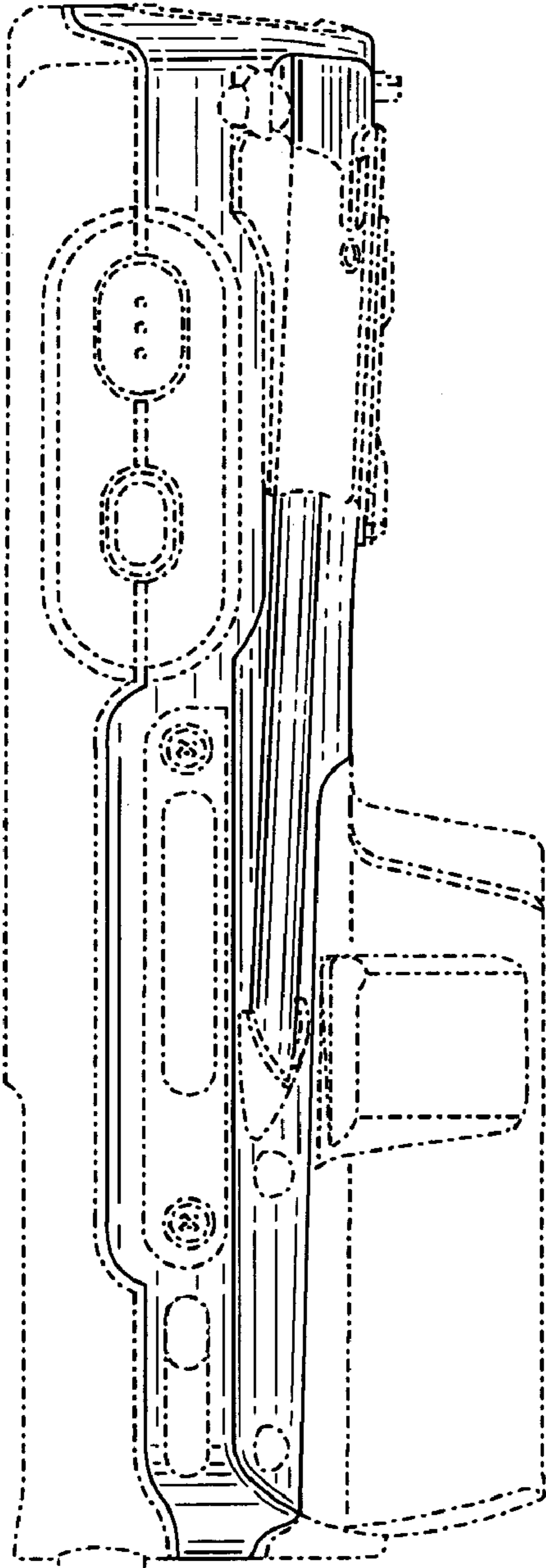

FIG. 5

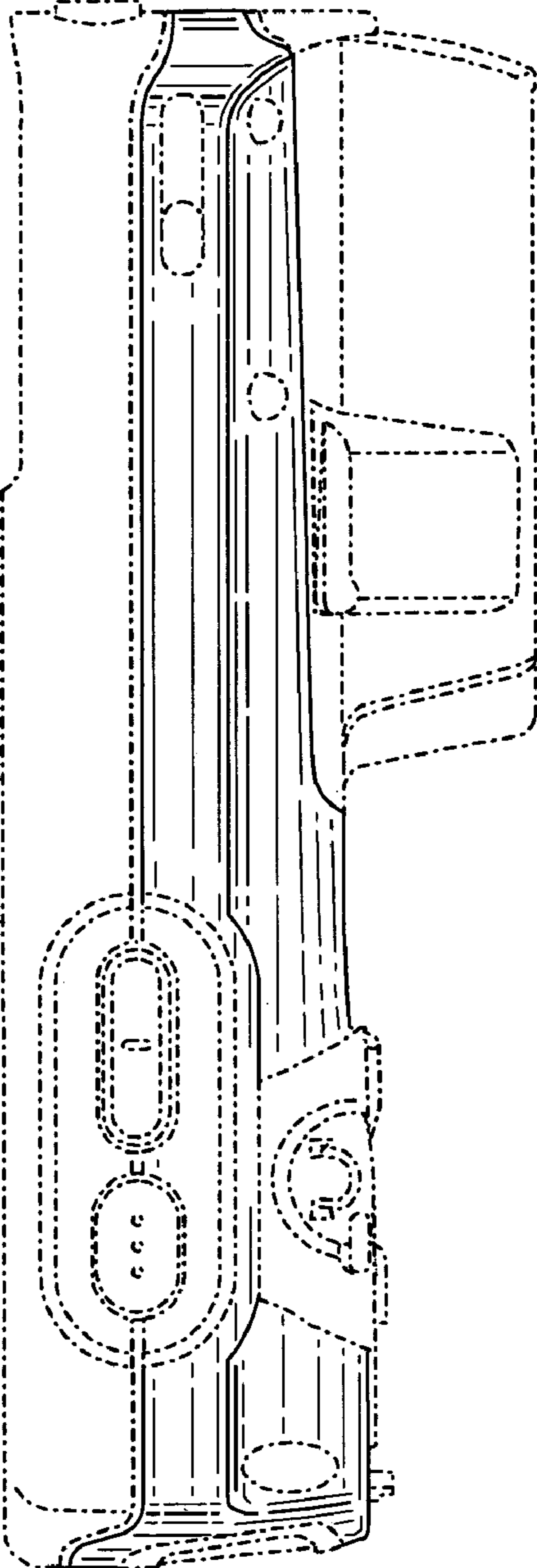

FIG. 6

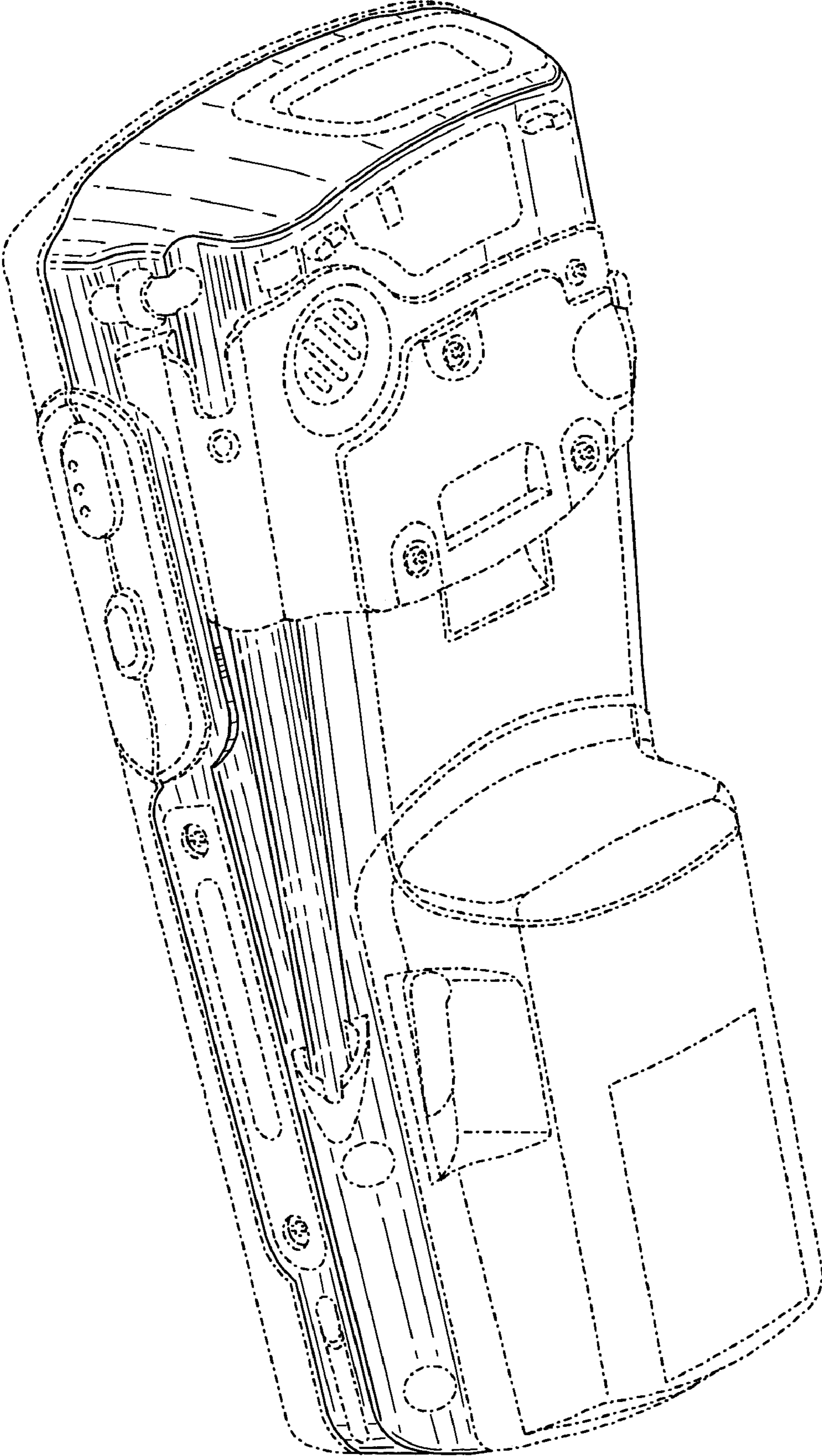

FIG. 7