

US00D568865S

(12) **United States Design Patent**  
**Wada et al.**

(10) **Patent No.:** **US D568,865 S**  
(45) **Date of Patent:** **\*\* May 13, 2008**

(54) **AMPLIFIER WITH DIGITAL VIDEO DISC  
PLAYER**

(75) Inventors: **Kosaku Wada**, Kadoma (JP);  
**Masakatsu Ito**, Kadoma (JP)

(73) Assignee: **Matsushita Electric Industrial Co.,  
Ltd.**, Osaka (JP)

(\*\*) Term: **14 Years**

(21) Appl. No.: **29/271,538**

(22) Filed: **Jan. 22, 2007**

(30) **Foreign Application Priority Data**

Aug. 4, 2006 (JP) ..... 2006-020694

(51) **LOC (8) Cl.** ..... **14-01**

(52) **U.S. Cl.** ..... **D14/168; D14/136**

(58) **Field of Classification Search** ..... D14/135–136,  
D14/156–157, 167–168, 257–258, 197–198,  
D14/188, 217, 445; 360/99.02, 99.07; 369/75.11,  
369/75.21, 77.21, 77.11; 720/612, 619, 647,  
720/655; 455/344, 347–351

See application file for complete search history.

(56) **References Cited**

**U.S. PATENT DOCUMENTS**

4,758,910 A \* 7/1988 Kaneko et al. .... D14/157  
D391,258 S \* 2/1998 Ito et al. .... D14/188  
5,859,828 A 1/1999 Ishibashi  
D459,334 S \* 6/2002 Tsuge ..... D14/156  
D515,549 S \* 2/2006 Mizokawa et al. .... D14/157  
D526,632 S \* 8/2006 Ryu ..... D14/136

**OTHER PUBLICATIONS**

Panasonic Consumer Electronics Company, "Panasonic 2006 /1  
Home Theater Catalogue—SC-HT740", 2006, 3 pages.

Wada, U.S. Design Application entitled "Amplifier With Digital  
Video Disc Player," U.S. Appl. No. 29/271,656, filed Jan. 24, 2007.

\* cited by examiner

*Primary Examiner*—Nanda Bondade

(74) *Attorney, Agent, or Firm*—Brinks Hofer Gilson &  
Lione

(57) **CLAIM**

We claim the ornamental design for an amplifier with digital  
video disc player, as shown and described.

**DESCRIPTION**

FIG. 1 is a top perspective view of a first embodiment of an  
amplifier with digital video disc player of the present  
invention;

FIG. 2 is a front view thereof;

FIG. 3 is a rear view thereof;

FIG. 4 is a top view thereof;

FIG. 5 is a bottom view thereof;

FIG. 6 is a first side view thereof;

FIG. 7 is a second side view thereof;

FIG. 8 is a top perspective view of a second embodiment of  
an amplifier with digital video disc player of the present  
invention;

FIG. 9 is a front view thereof;

FIG. 10 is a rear view thereof;

FIG. 11 is a top view thereof;

FIG. 12 is a bottom view thereof;

FIG. 13 is a first side view thereof; and,

FIG. 14 is a second side view thereof.

**1 Claim, 8 Drawing Sheets**

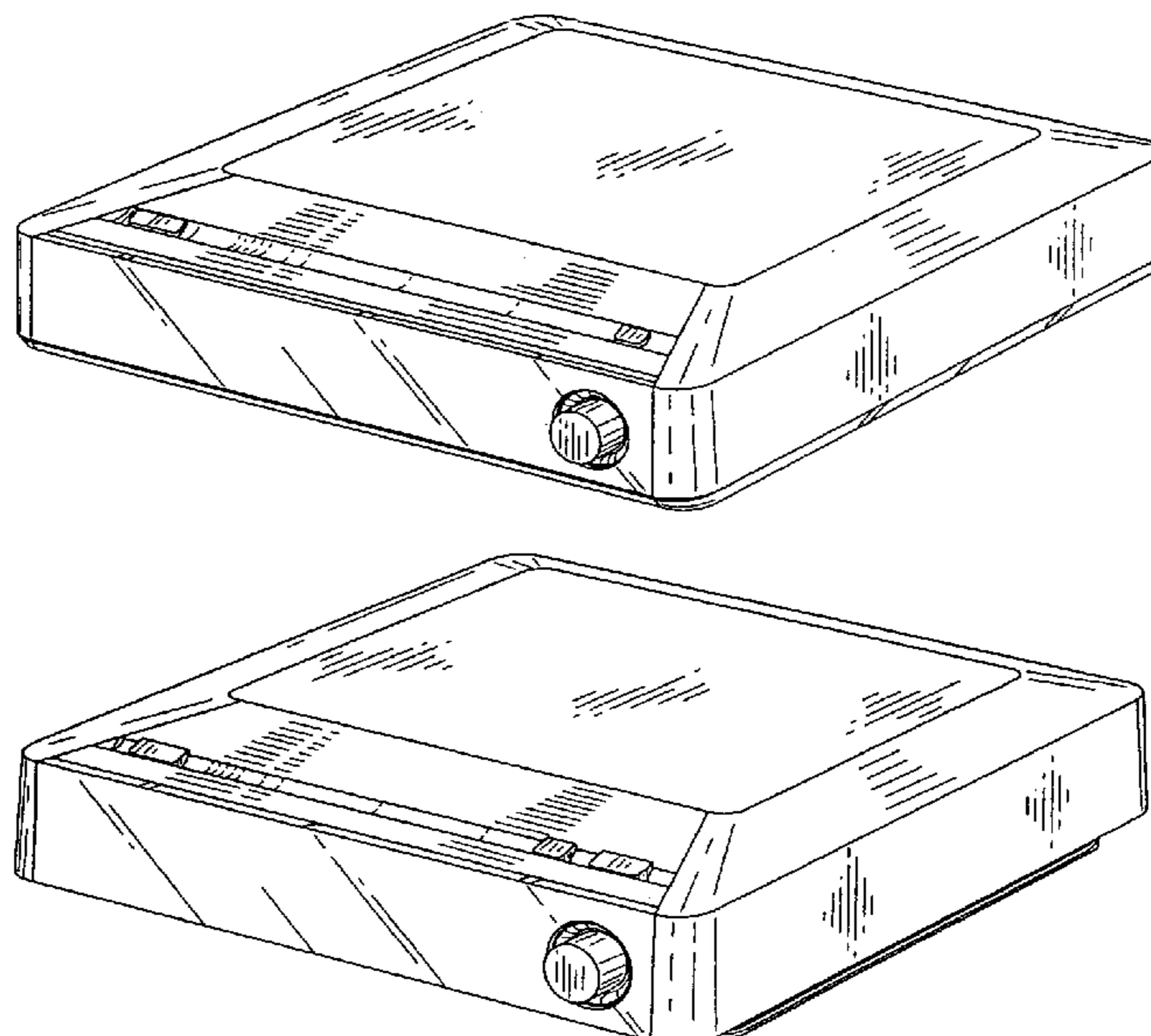

FIG.1

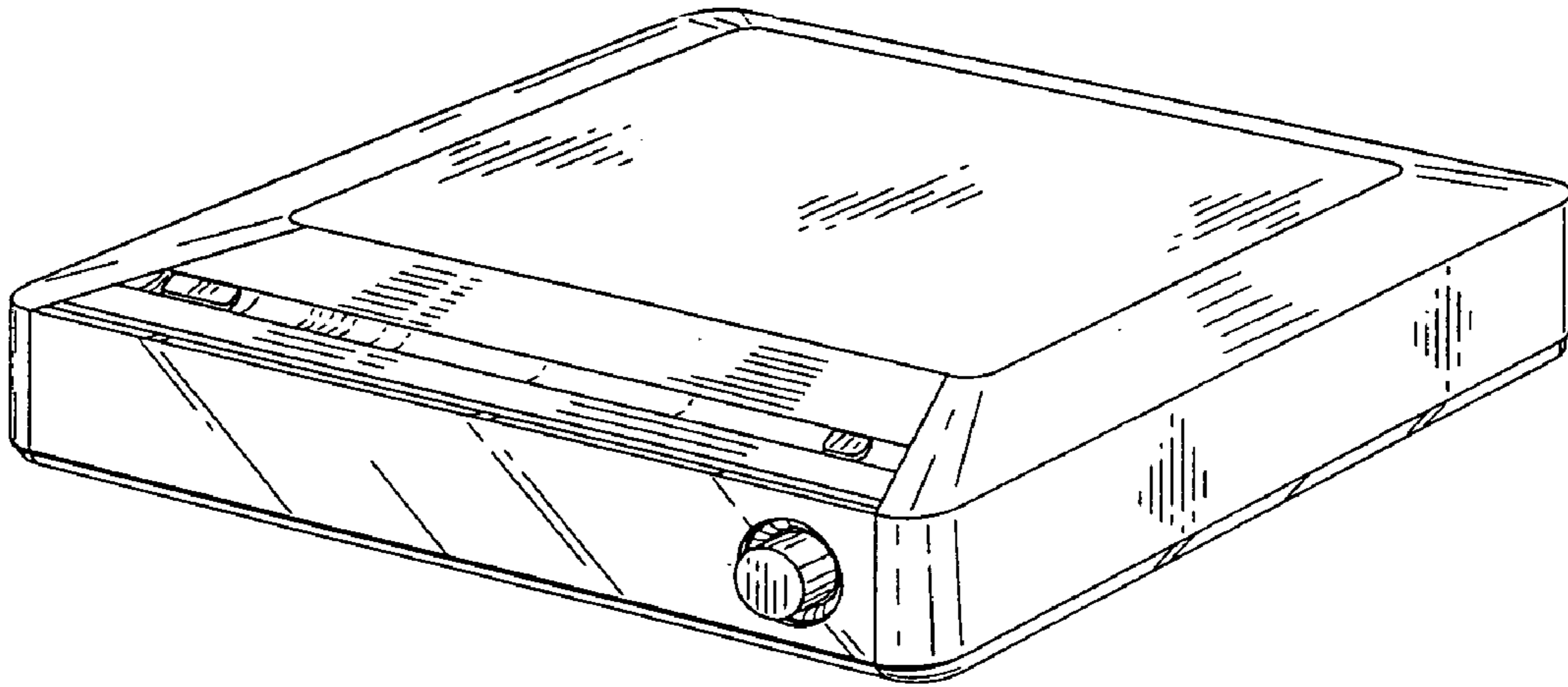

FIG.2

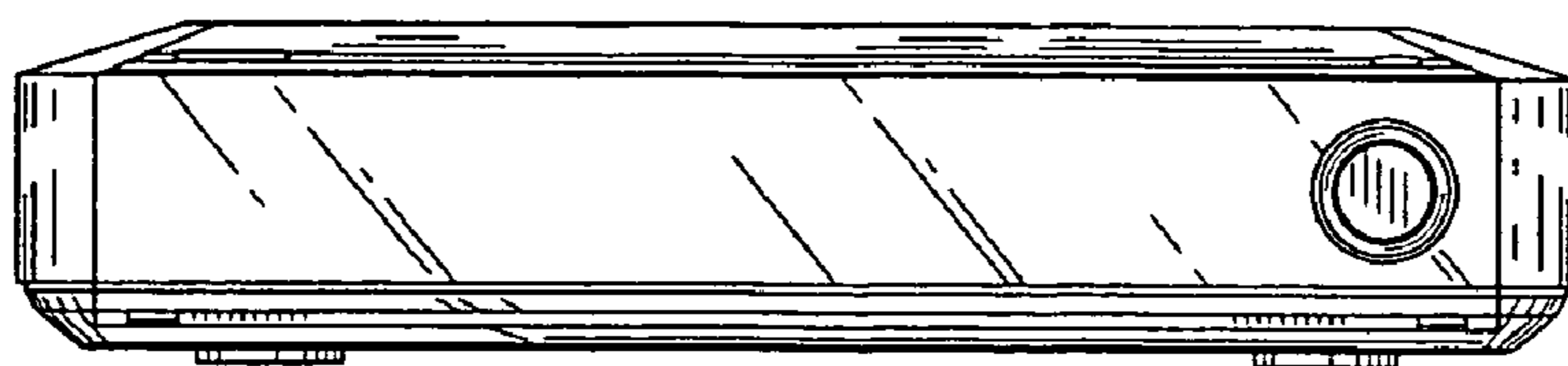

FIG.3

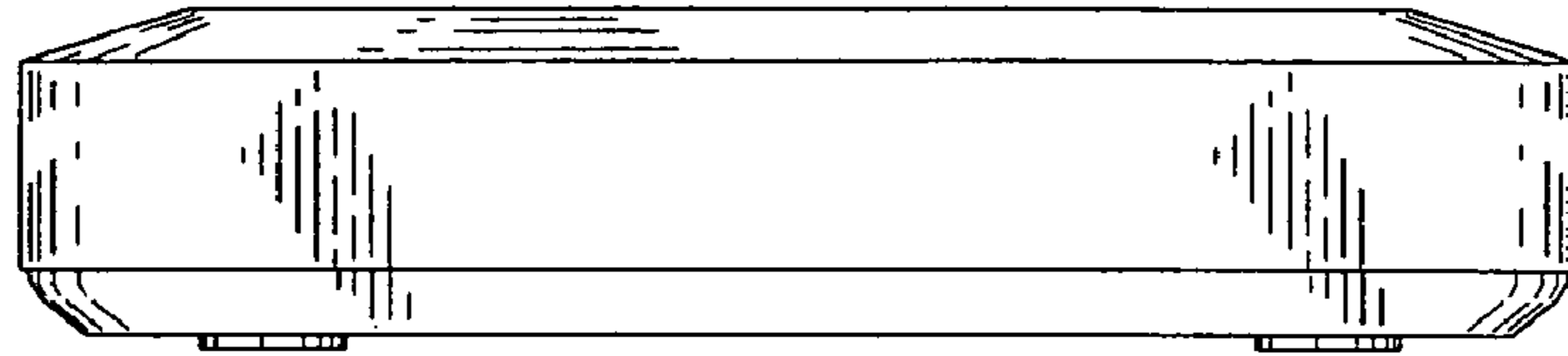

FIG.4

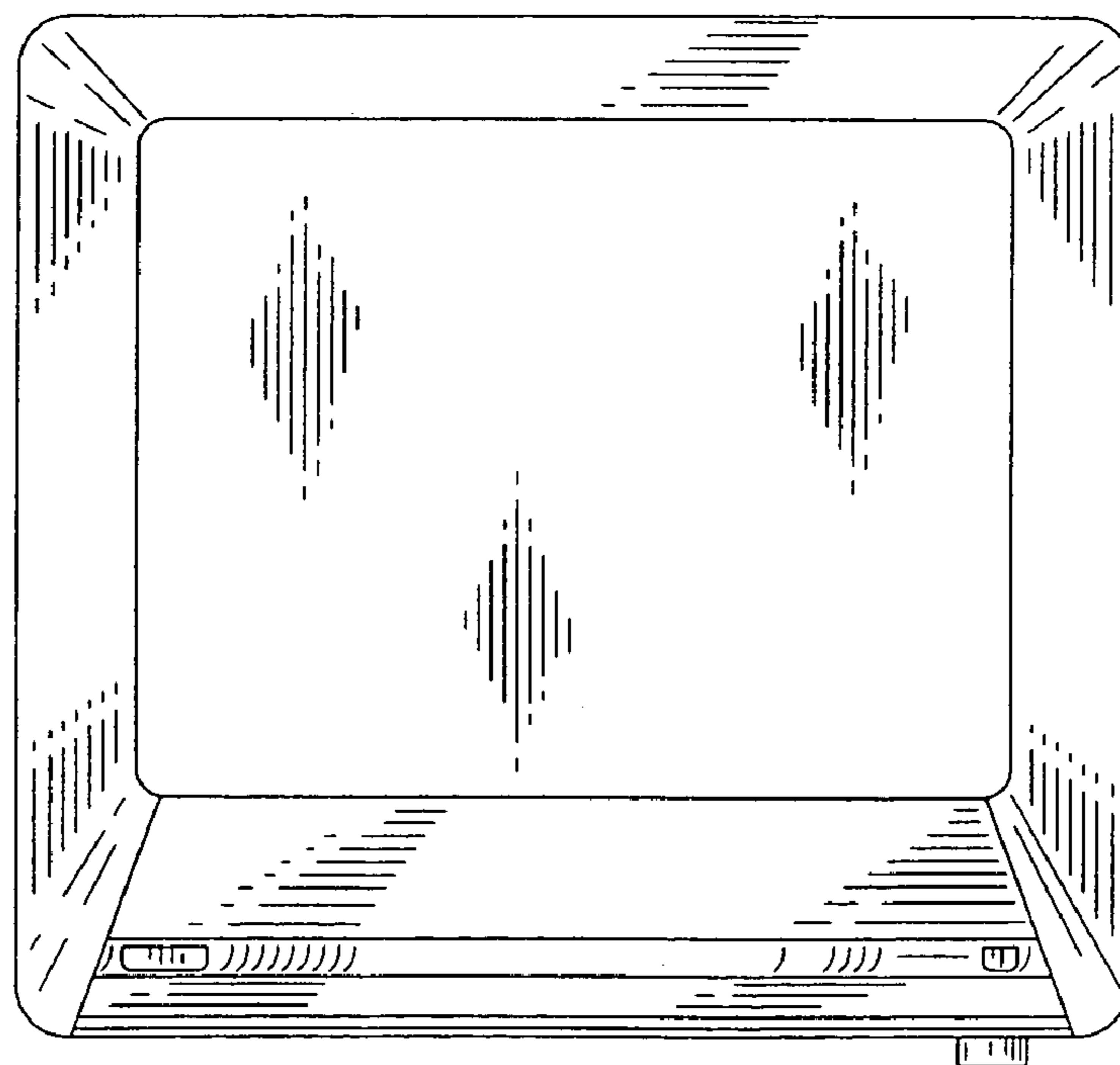

FIG.5

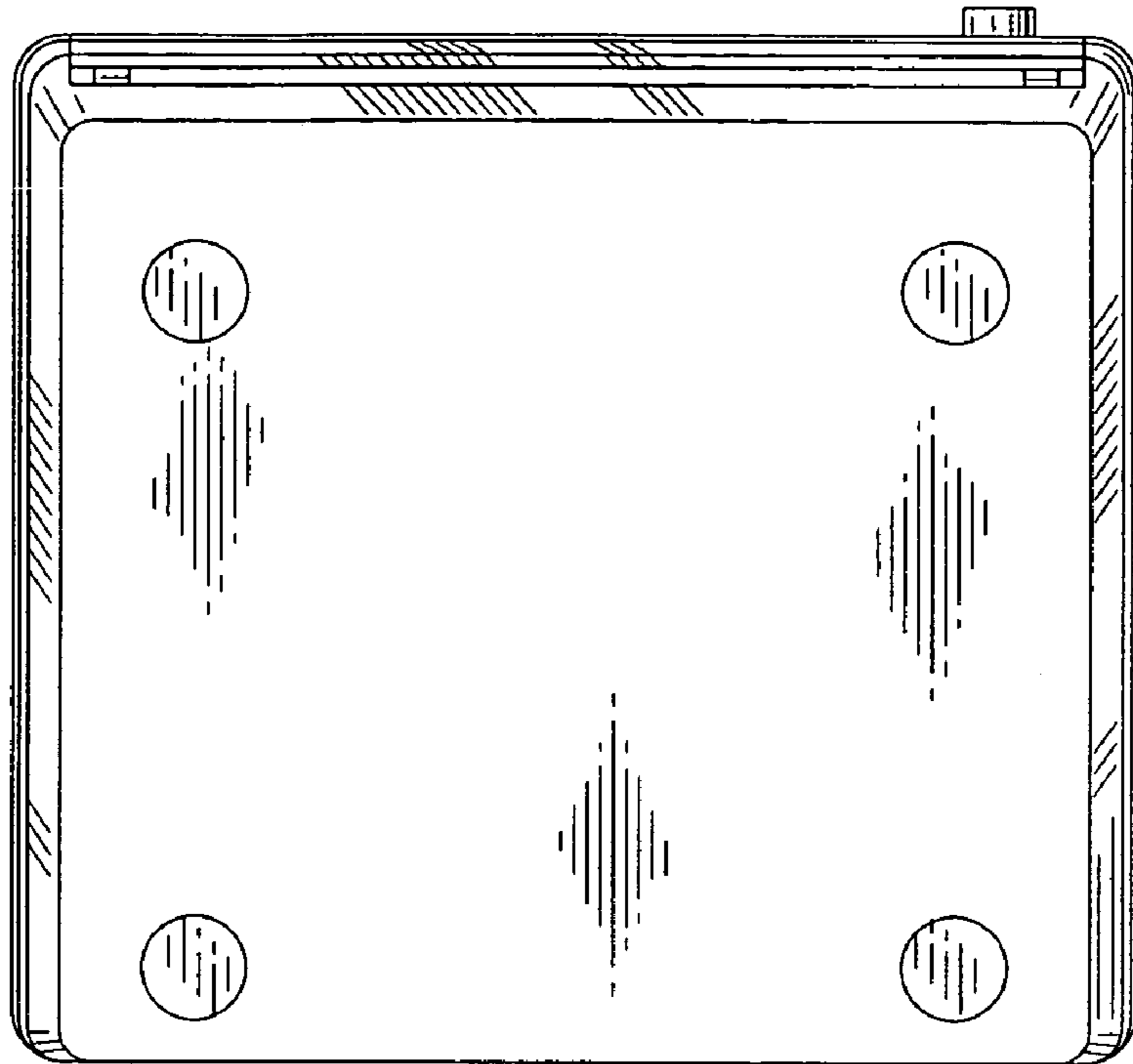
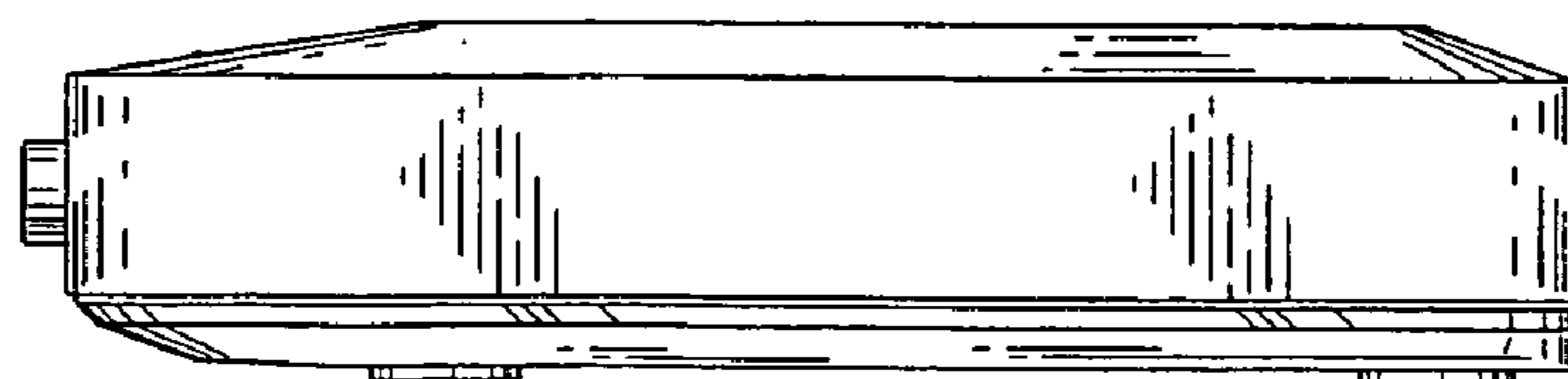

FIG.6



*FIG.7*

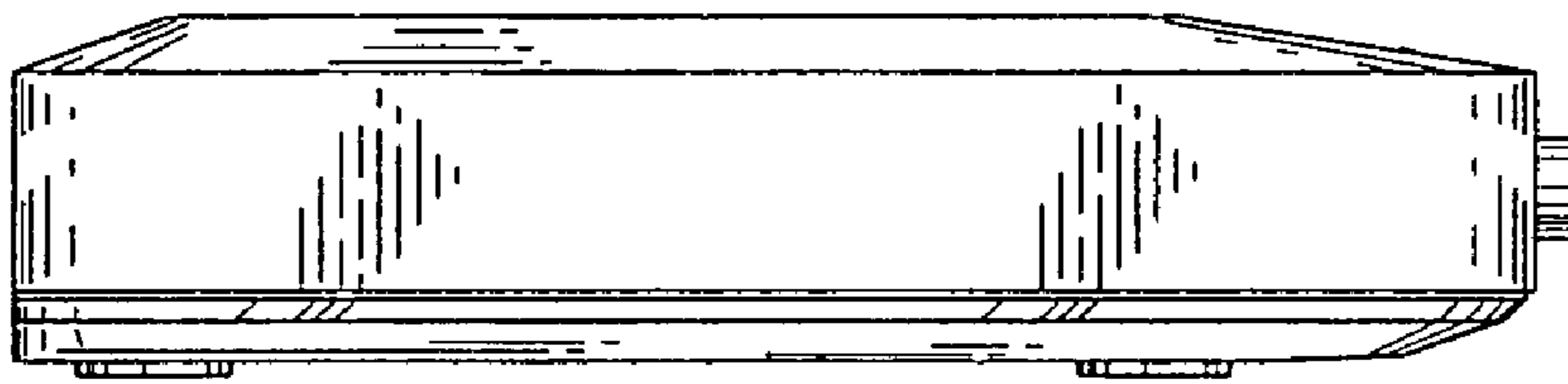

FIG.8

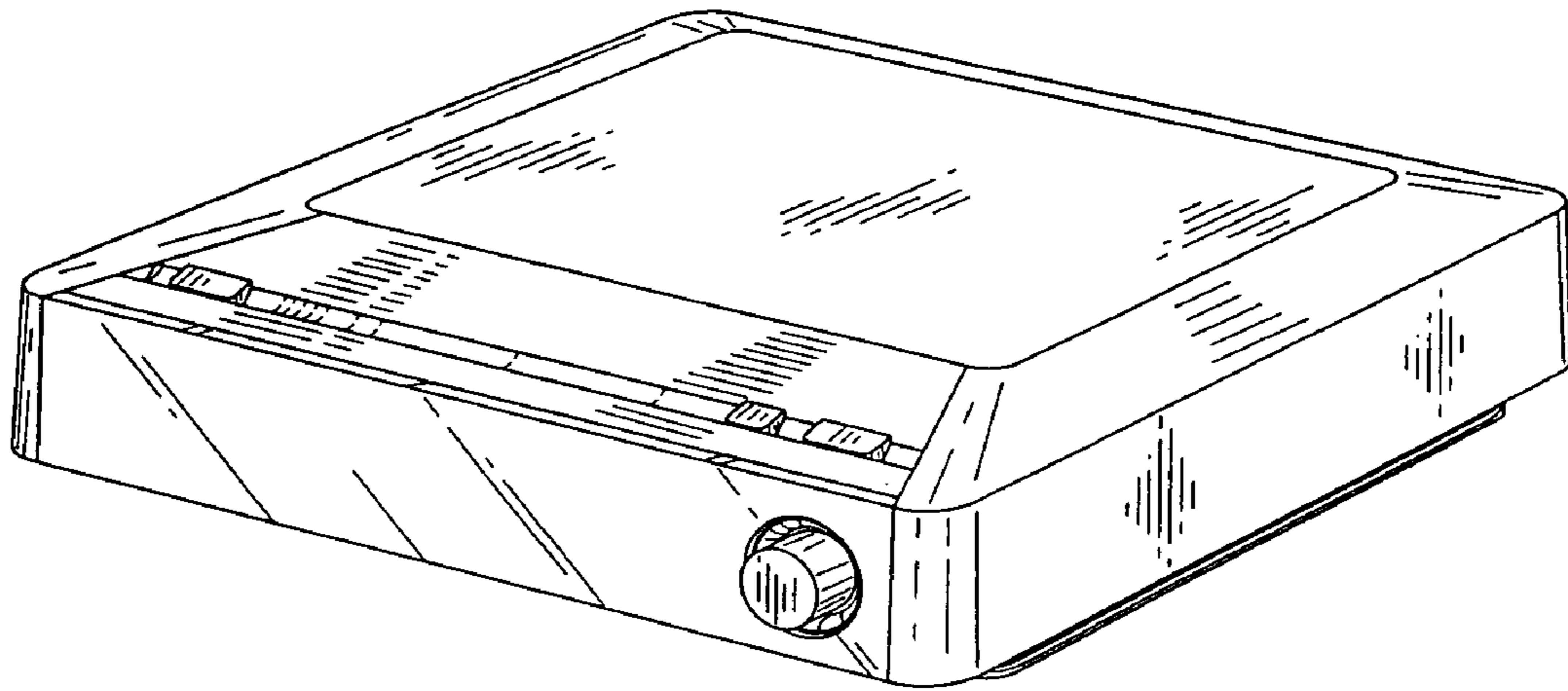

FIG.9

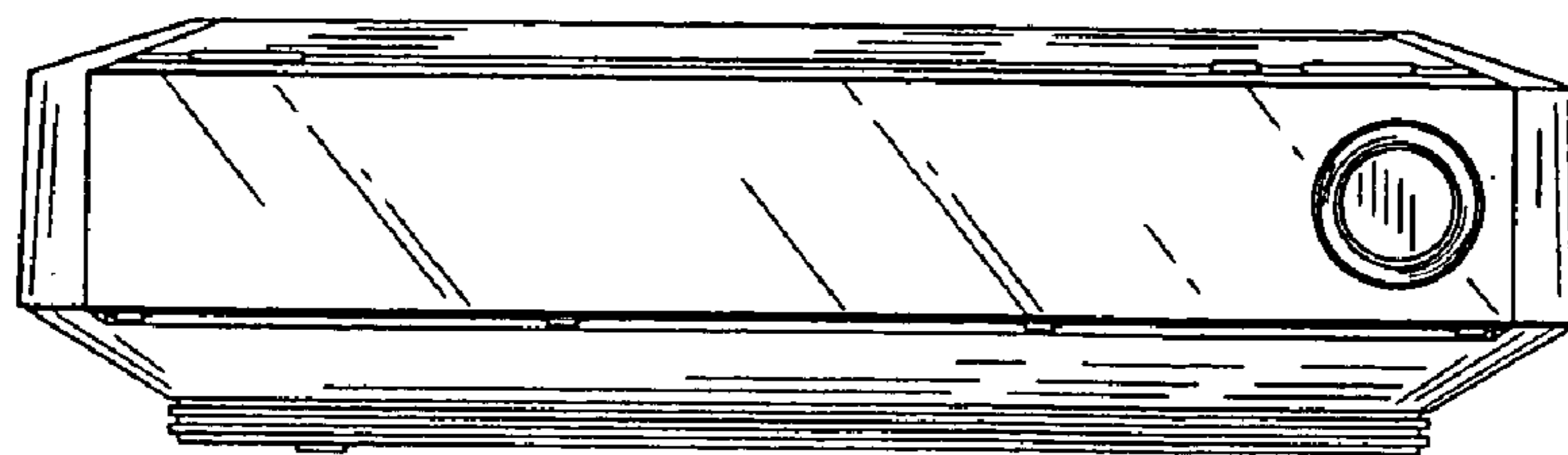

FIG. 10

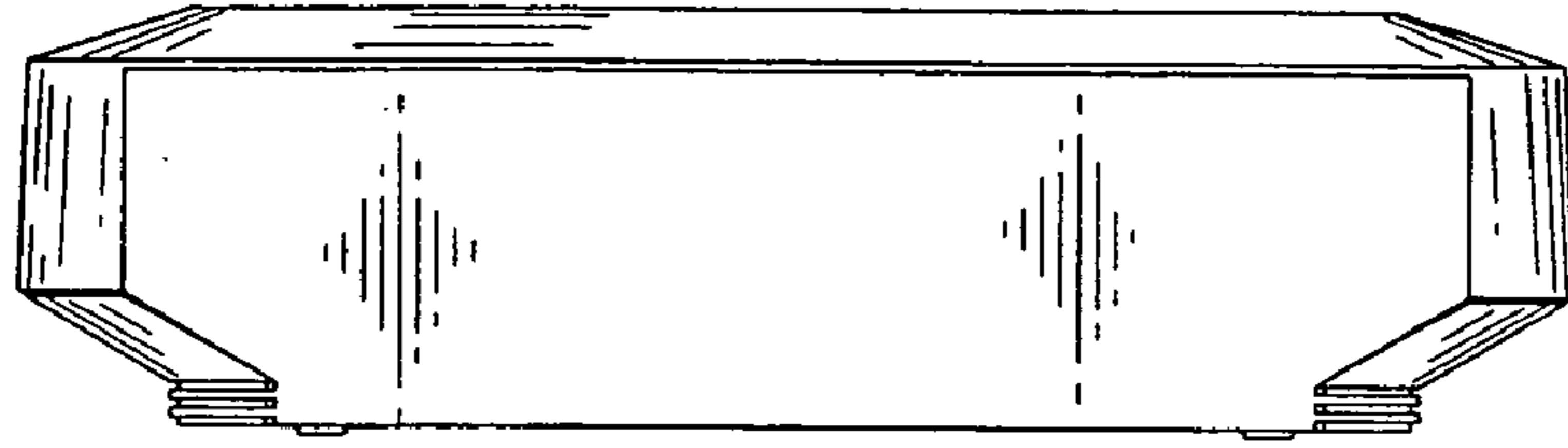

FIG. 11

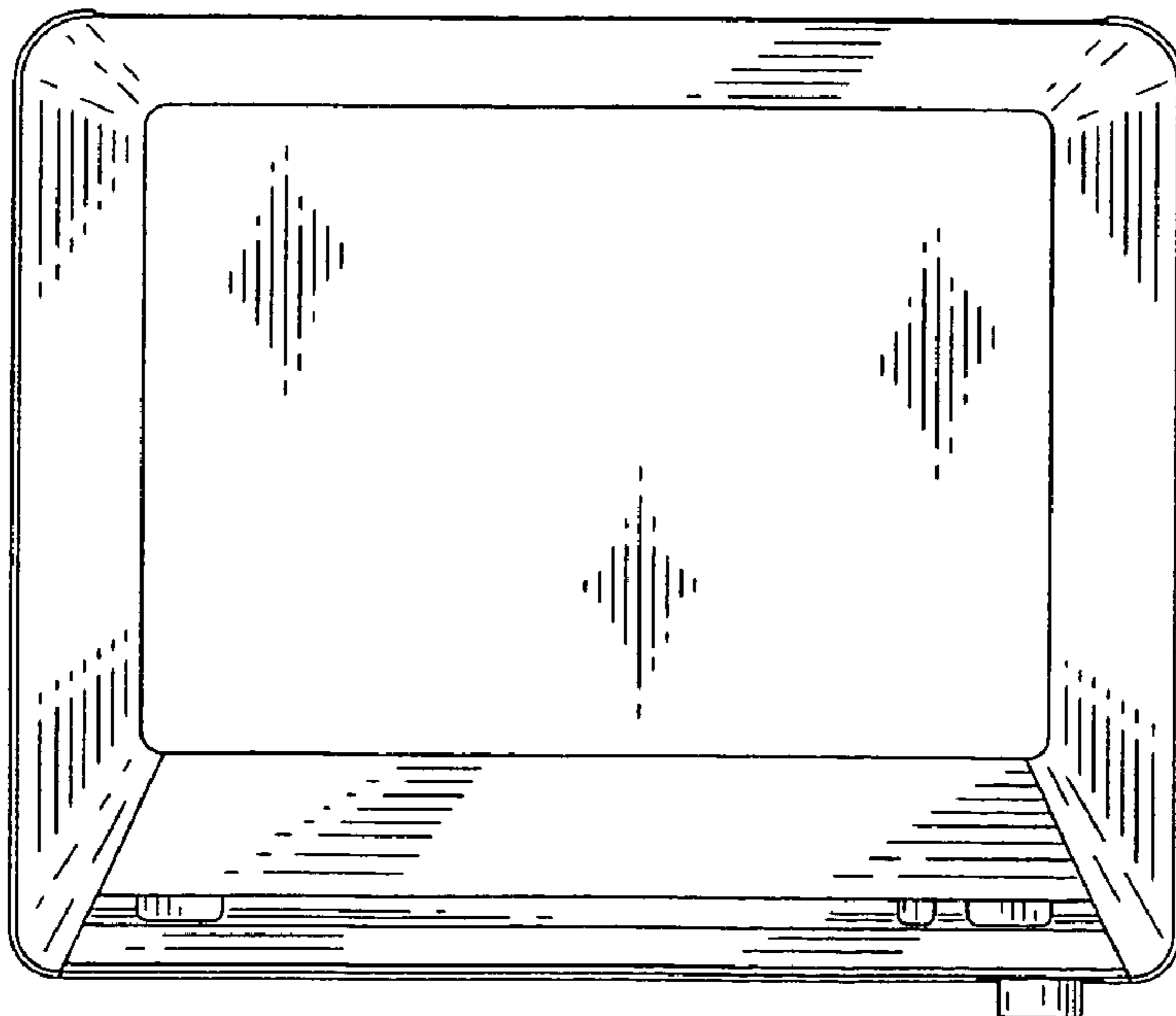

FIG.12

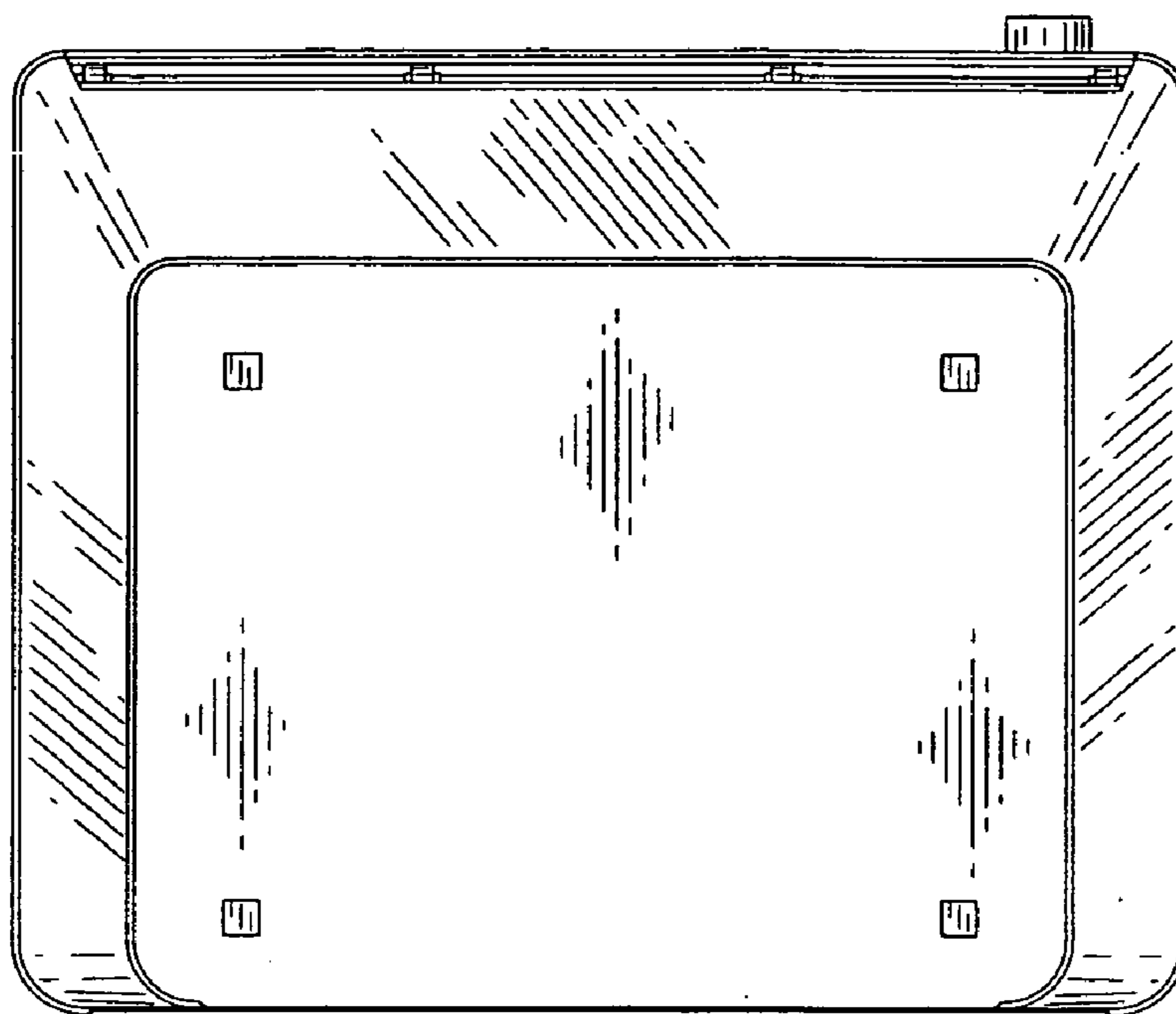
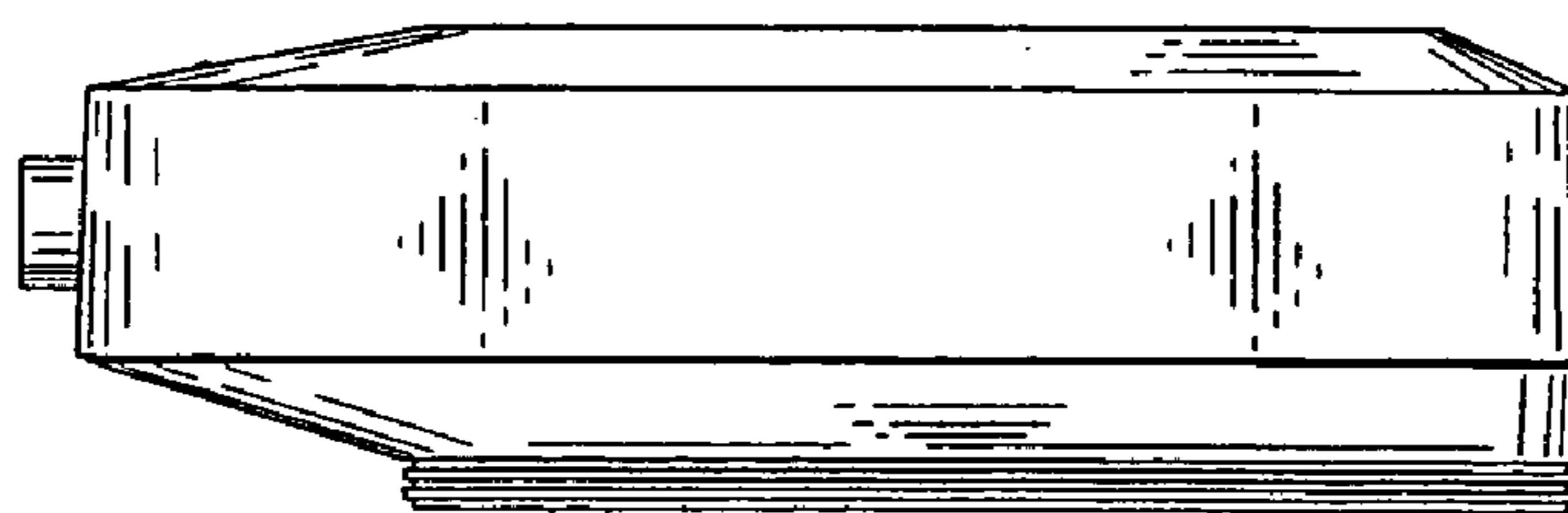

FIG.13





*FIG. 14*

