



US00D568862S

(12) **United States Design Patent**
Kim et al.

(10) **Patent No.:** **US D568,862 S**

(45) **Date of Patent:** **** May 13, 2008**

(54) **MOBILE PHONE**

(75) Inventors: **Yun-Su Kim**, Seoul (KR); **Jun-Sang Park**, Anyang-si (KR)

(73) Assignee: **Samsung Electronics Co., Ltd.**, Suwon-Si (KR)

(**) Term: **14 Years**

(21) Appl. No.: **29/287,714**

(22) Filed: **Sep. 11, 2007**

(30) **Foreign Application Priority Data**

Jul. 9, 2007 (KR) 30-2007-0029573

(51) **LOC (8) Cl.** **14-03**

(52) **U.S. Cl.** **D14/138**

(58) **Field of Classification Search** D14/138,
D14/496, 137, 147, 191, 218, 247-248, 341-347;
D13/168; D18/7; 455/575.4, 90.3, 556.1,
455/556.2, 575.1, 575.3; 379/433.01-433.13;
361/814; 348/14.02

See application file for complete search history.

(56) **References Cited**

U.S. PATENT DOCUMENTS

D365,997 S *	1/1996	Wrisley et al.	D10/78
D372,248 S *	7/1996	Tahmassebpur	D14/242
D459,667 S *	7/2002	Kataoka	D10/80
D506,937 S *	7/2005	Lee et al.	D10/65
D512,391 S *	12/2005	Chiu	D14/136
D525,609 S *	7/2006	Kim et al.	D14/138
D528,541 S *	9/2006	Maskatia	D14/315
D529,904 S *	10/2006	Yeo	D14/240
D531,156 S *	10/2006	Ahn et al.	D14/138
7,197,338 B2 *	3/2007	Ozawa	455/566
D542,768 S *	5/2007	Hwang et al.	D14/138
D542,769 S *	5/2007	Hwang et al.	D14/138
D547,295 S *	7/2007	Park	D14/138
D548,214 S *	8/2007	Kim et al.	D14/138
D548,733 S *	8/2007	Johansson	D14/341
D551,647 S *	9/2007	Kim et al.	D14/138
D555,616 S *	11/2007	Lin	D14/138
D557,239 S *	12/2007	Lee	D14/138
D557,674 S *	12/2007	Lee et al.	D14/138

D559,220 S *	1/2008	Lee et al.	D14/138
D560,192 S *	1/2008	Lee et al.	D14/138
2004/0058703 A1 *	3/2004	Eromaki et al.	455/550.1
2004/0087346 A1 *	5/2004	Johannsen et al.	455/566
2006/0142074 A1 *	6/2006	Impio et al.	455/575.4
2007/0072657 A1 *	3/2007	Hyun et al.	455/575.3
2007/0259702 A1 *	11/2007	Kemppinen	455/575.4

OTHER PUBLICATIONS

Samsung D720, announced 1st quarter 2005, [online], [retrieved on Feb. 8, 2007]. Retrieved from Internet ,<URL: http://www.gsmarena.com>.*

Eten glofish M800, announced Oct. 2007, [online], [retrieved on Dec. 13, 2007]. Retrieved from Internet ,<URL: http://www.gsmarena.com>.*

i-mate Ultimate 9502, announced Oct. 2007, [online], [retrieved on Dec. 13, 2007]. Retrieved from Internet ,<URL: http://www.gsmarena.com>.*

Eten glofish X600, announced Oct. 2007, [online], [retrieved on Dec. 13, 2007]. Retrieved from Internet ,<URL: http://www.gsmarena.com>.*

* cited by examiner

Primary Examiner—Jeffrey D. Asch

Assistant Examiner—Bridget L Eland

(74) *Attorney, Agent, or Firm*—Staas & Halsey LLP

(57) **CLAIM**

The ornamental design for a mobile phone, as shown and described.

DESCRIPTION

FIG. 1 is a perspective view of a mobile phone;
FIG. 2 is a front view of the mobile phone of FIG. 1;
FIG. 3 is a rear view of the mobile phone of FIG. 1;
FIG. 4 is left-side of the mobile phone of FIG. 1;
FIG. 5 is right-side of the mobile phone of FIG. 1;
FIG. 6 is top plan view of the mobile phone of FIG. 1;
FIG. 7 is bottom plan view of the mobile phone of FIG. 1;
and,
FIG. 8 is an open perspective view of the mobile phone of FIG. 1.

1 Claim, 6 Drawing Sheets

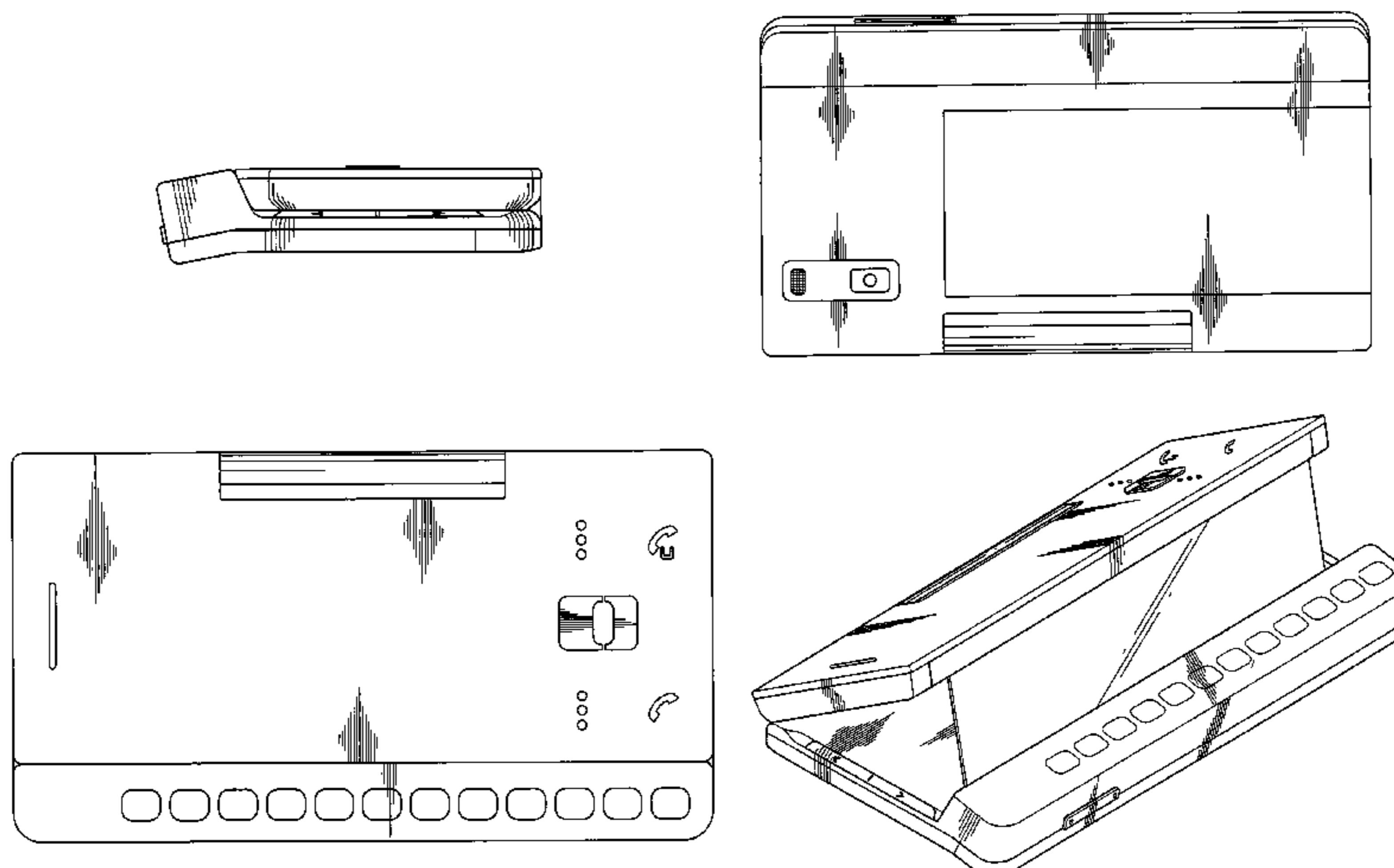

FIG. 1

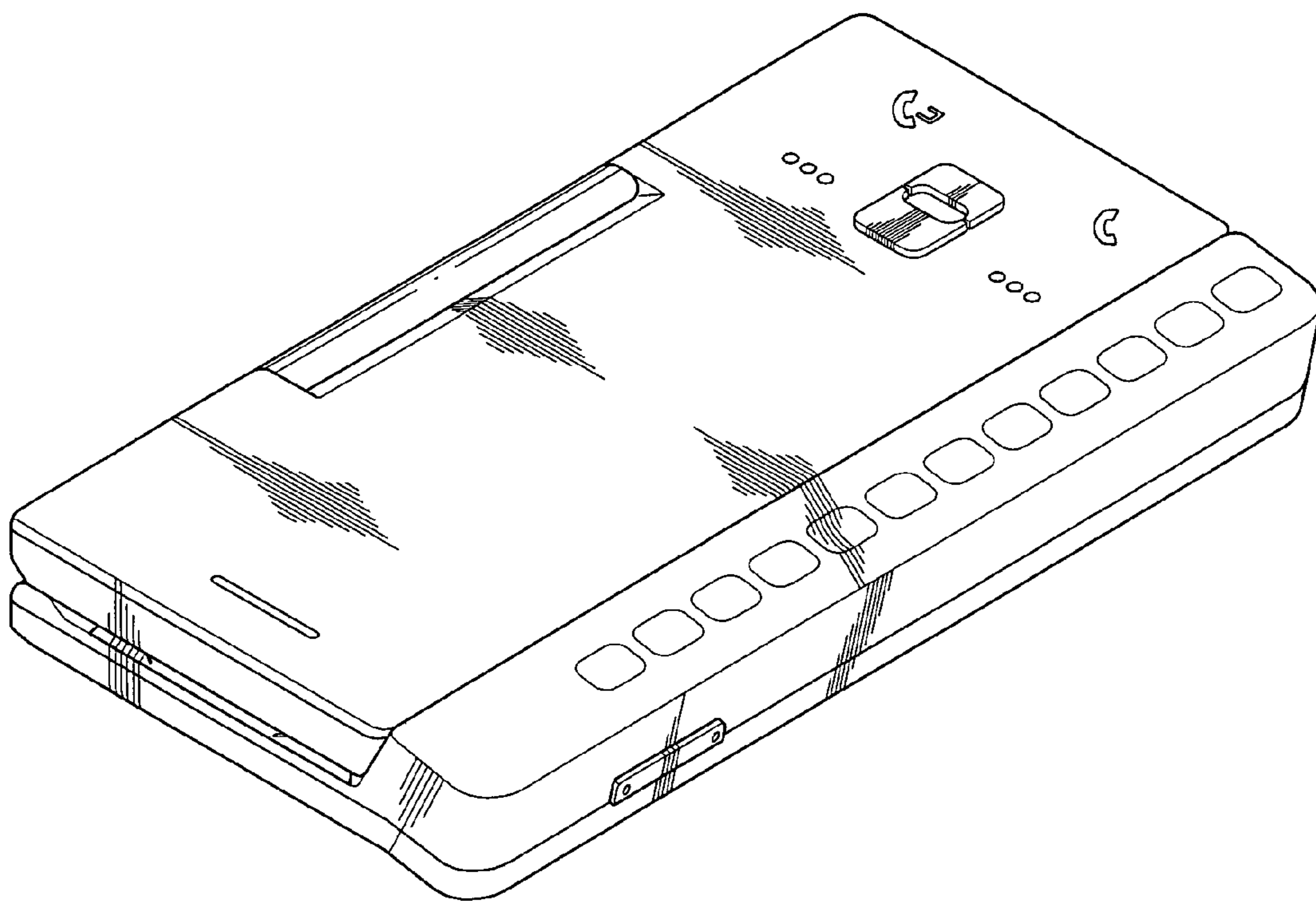

FIG.2

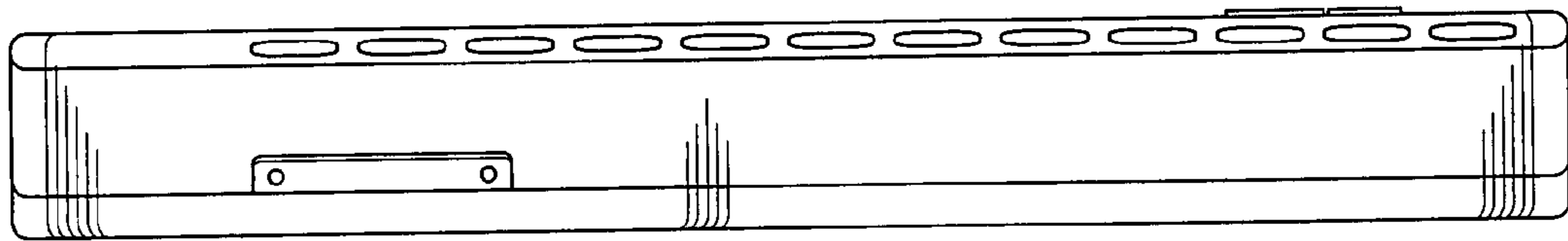

FIG.3

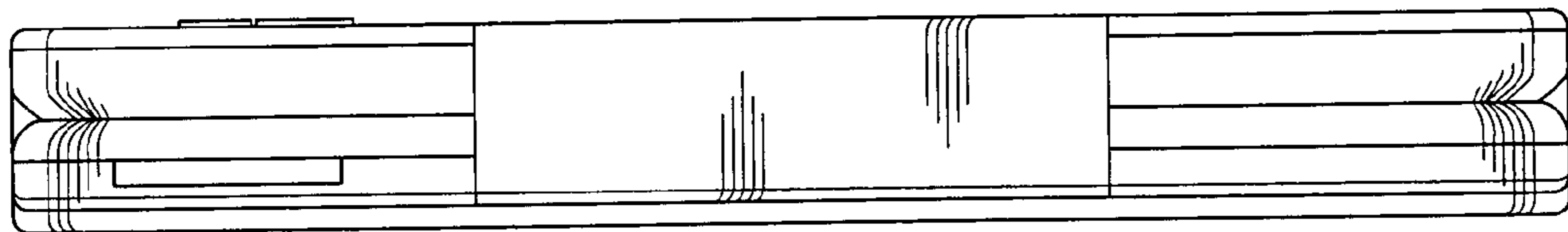

FIG. 4

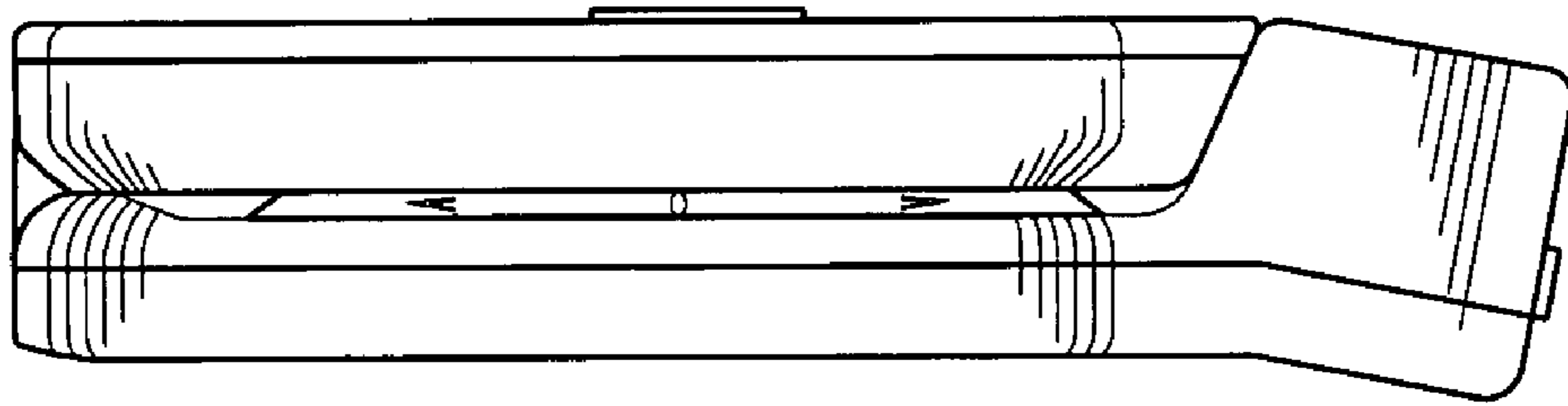

FIG. 5

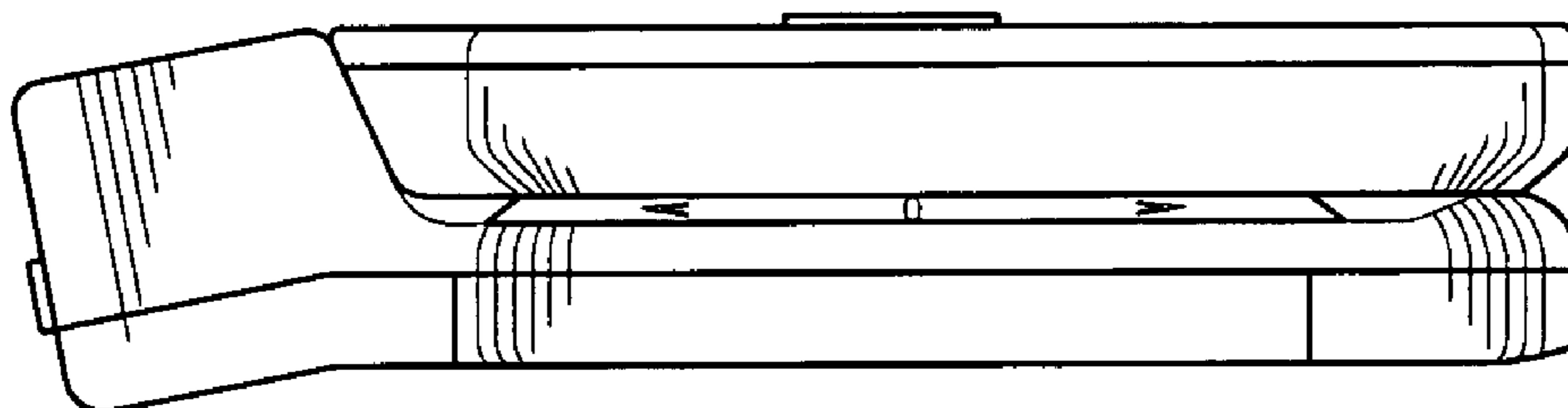

FIG. 6

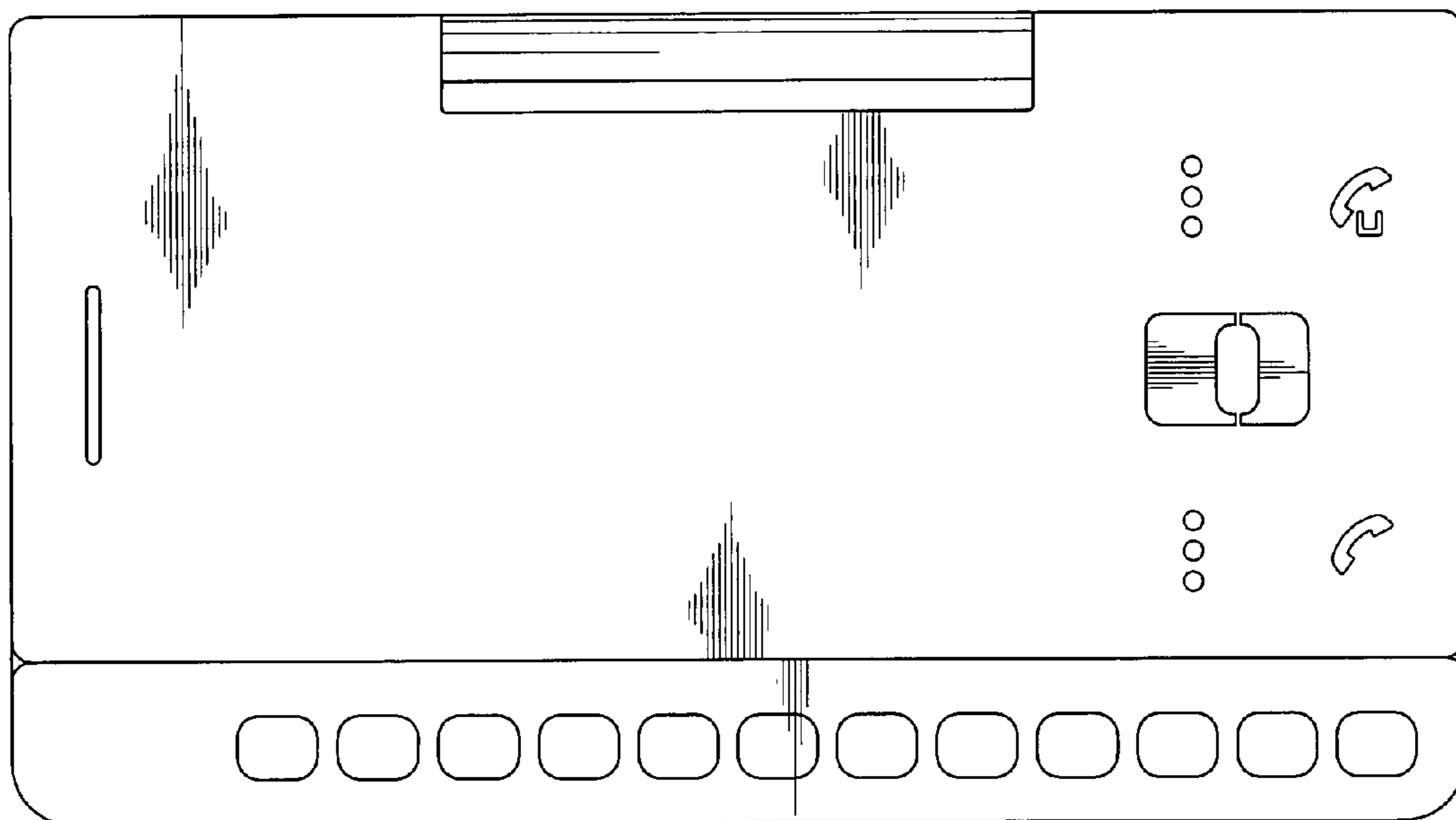

FIG. 7

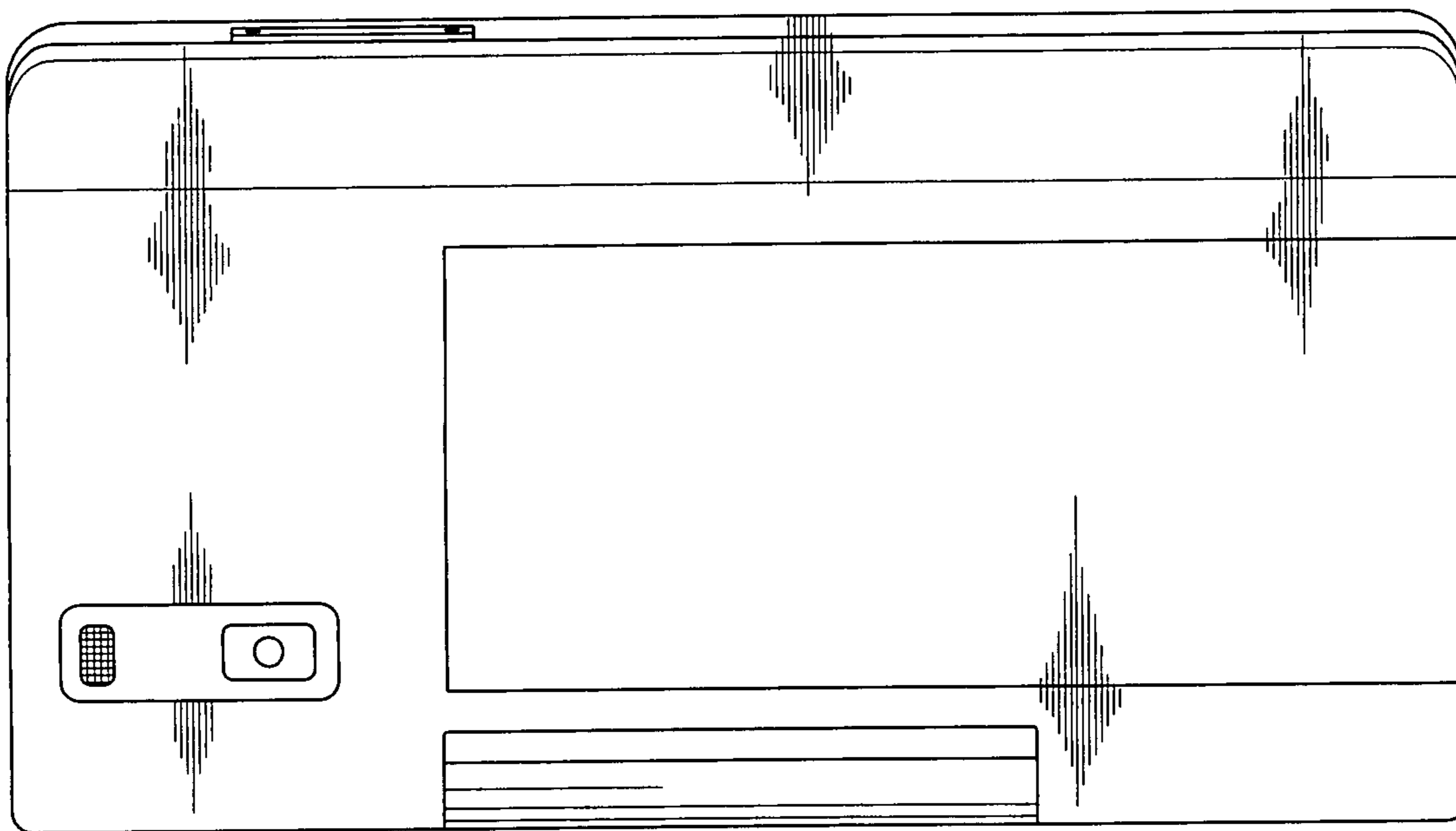

FIG. 8

