



US00D568694S

(12) **United States Design Patent**
Furlong

(10) **Patent No.:** **US D568,694 S**
(45) **Date of Patent:** **** May 13, 2008**

(54) **FOOD STORAGE CONTAINER**

(57) **CLAIM**

(75) Inventor: **Brian D. Furlong**, Davidson, NC (US)

The ornamental design for a “food storage container,” as shown and described.

(73) Assignee: **Rubbermaid Incorporated**,
Huntersville, NC (US)

DESCRIPTION

(**) Term: **14 Years**

FIG. 1 is a top, front, and right side perspective view showing my new design for a food storage container.

(21) Appl. No.: **29/279,430**

FIG. 2 is a top view of the food storage container shown in FIG. 1.

(22) Filed: **Apr. 30, 2007**

FIG. 3 is a front view of the food storage container shown in FIG. 1, the rear view being a mirror image thereof.

Related U.S. Application Data

(63) Continuation-in-part of application No. 11/673,378, filed on Feb. 9, 2007.

FIG. 4 is a bottom view of the food storage container shown in FIG. 1.

(51) **LOC (8) Cl.** **07-06**

FIG. 5 is a right side view of the food storage container shown in FIG. 1, the left side being a mirror image thereof.

(52) **U.S. Cl.** **D7/629**

FIG. 6 is an exploded view of the food storage container shown in FIG. 1.

(58) **Field of Classification Search** D7/602,
D7/629, 612–615, 538–542; D9/424–432;
220/780–806, 241, 242, 556, 287

See application file for complete search history.

FIG. 7 is a right side view of several alternate size embodiments of the food storage container shown in FIG. 1.

(56) **References Cited**

FIG. 8 is a top, front, and right side perspective view showing an alternate embodiment of my new design for a food storage container.

U.S. PATENT DOCUMENTS

2,412,325 A 12/1946 Devine et al.

FIG. 9 is a top view of the food storage container shown in FIG. 8.

(Continued)

FOREIGN PATENT DOCUMENTS

WO WO 03/062070 7/2003

FIG. 10 is a front view of the food storage container shown in FIG. 8, the rear view being a mirror image thereof.

OTHER PUBLICATIONS

Product literature for Trouve food storage containers from www.savethelids.com.

FIG. 11 is a bottom view of the food storage container shown in FIG. 8.

Product literature for Snap Saver food storage containers from www.snap-saver.com.

FIG. 12 is a right side view of the food storage container shown in FIG. 8, the left side being a mirror image thereof.

International Search Report and Written Opinion issued in International utility application No. PCT/US2007/061925 mailed Jul. 13, 2007.

FIG. 13 is an exploded view of the food storage container shown in FIG. 8; and,

Primary Examiner—Terry A Wallace

FIG. 14 is a right side view of several alternate size embodiments of the food storage container shown in FIG. 8.

(74) *Attorney, Agent, or Firm*—Lempia Braidwood LLC

The dashed lines are for illustrative purposes only and form no part of my claimed design.

1 Claim, 8 Drawing Sheets

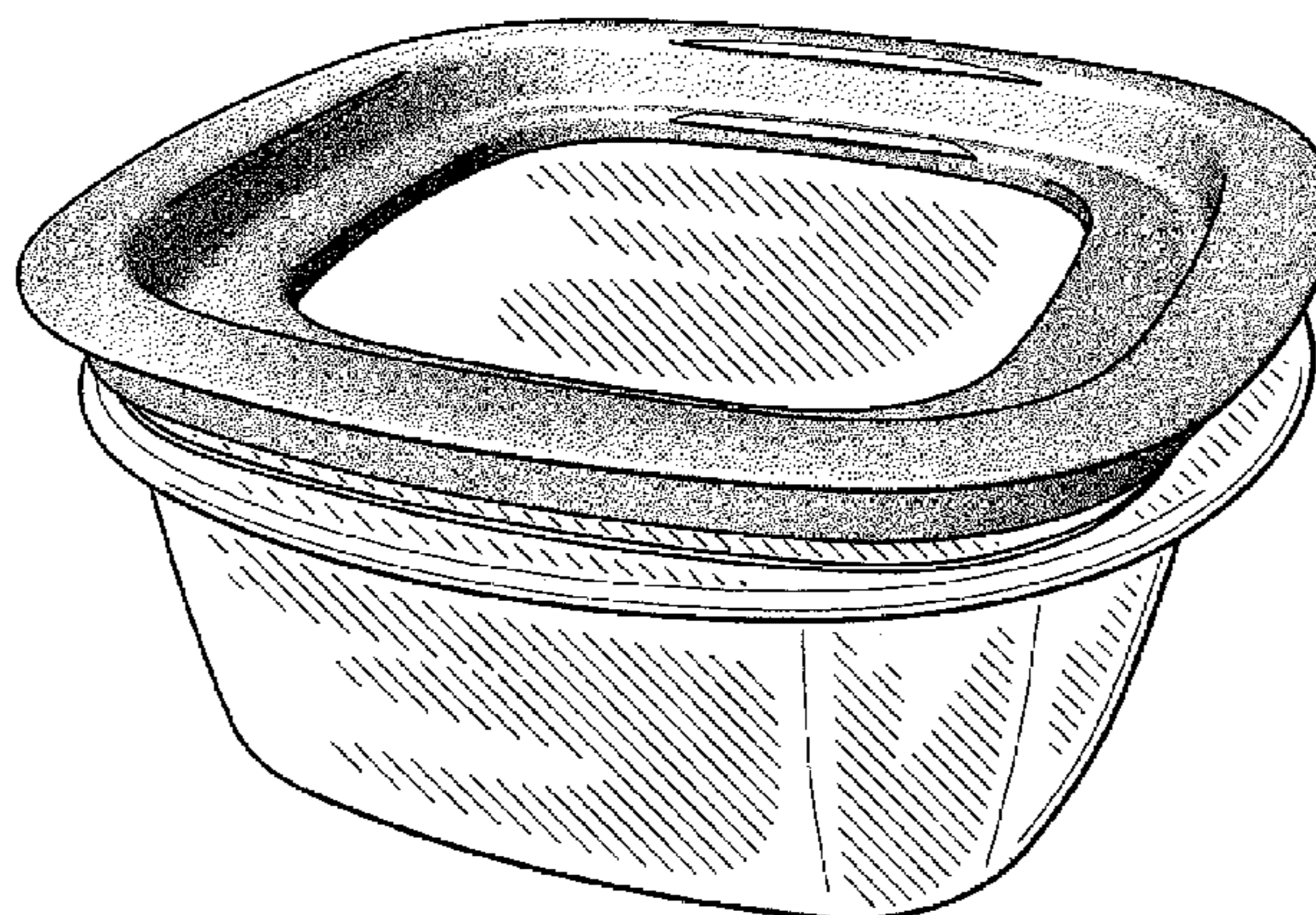

US D568,694 S

Page 2

U.S. PATENT DOCUMENTS				
		5,409,126 A	4/1995	Demars
3,137,409 A	6/1964 Davis	5,409,128 A	4/1995	Mitchell
3,722,731 A	3/1973 McCormick et al.	5,586,656 A	12/1996	Abrums
3,730,385 A	5/1973 Rost	5,692,617 A	12/1997	Adams
3,784,052 A	1/1974 Edwards	5,769,229 A	6/1998	Andress et al.
3,989,142 A	11/1976 Gwilliam, Jr. et al.	5,775,483 A	7/1998	Lown et al.
4,082,184 A	4/1978 Hammer	5,799,792 A	9/1998	Abrums
4,127,189 A	11/1978 Schumrak et al.	5,992,679 A *	11/1999	Porchia et al. 220/782
4,183,446 A	1/1980 Davis	D419,829 S *	2/2000	Wilson et al. D7/629
4,204,609 A	5/1980 Kuhn	D475,620 S *	6/2003	Chen et al. D9/425
4,407,426 A	10/1983 McLaren et al.	6,571,981 B2	6/2003	Rohlfs
4,412,630 A *	11/1983 Daenen 220/792	6,685,049 B1	2/2004	Paladino
4,446,969 A	5/1984 Tyler	6,708,824 B2	3/2004	Sahm, III
4,685,582 A	8/1987 Pulciani et al.	6,729,472 B2	5/2004	Stucke et al.
4,700,842 A	10/1987 Grusin	6,796,430 B2	9/2004	Mercier et al.
4,804,092 A	2/1989 Jones	6,886,694 B2	5/2005	McNeeley et al.
4,951,832 A	8/1990 Tenney et al.	D507,155 S *	7/2005	Gosen et al. D7/629
5,184,745 A	2/1993 Havens et al.	2005/0109654 A1	5/2005	Kolar et al.
5,220,999 A	6/1993 Goulette			
5,312,011 A	5/1994 Fischer			
D355,814 S *	2/1995 VanValkenburg et al. D7/629			

* cited by examiner

FIG. 1

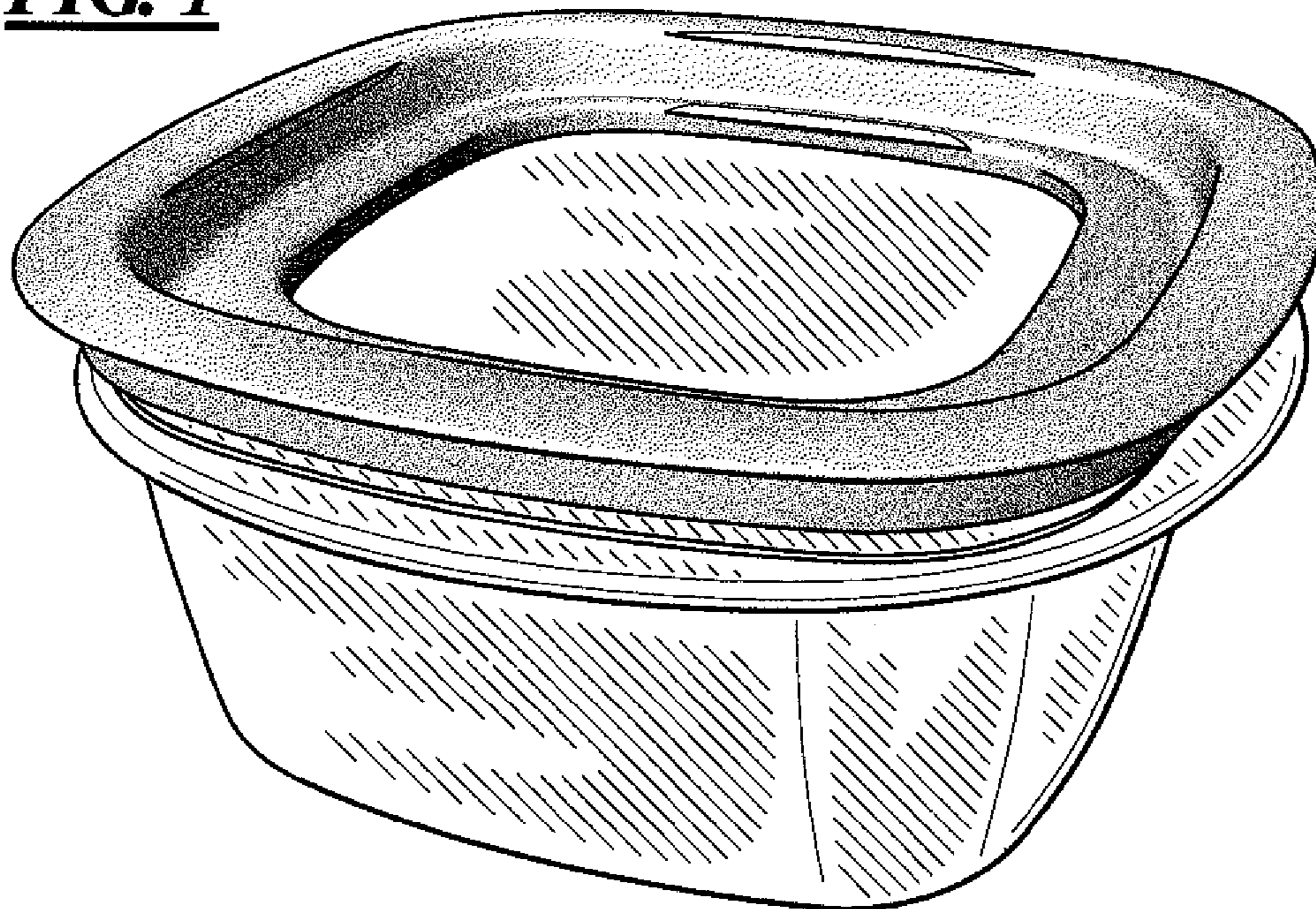

FIG. 2

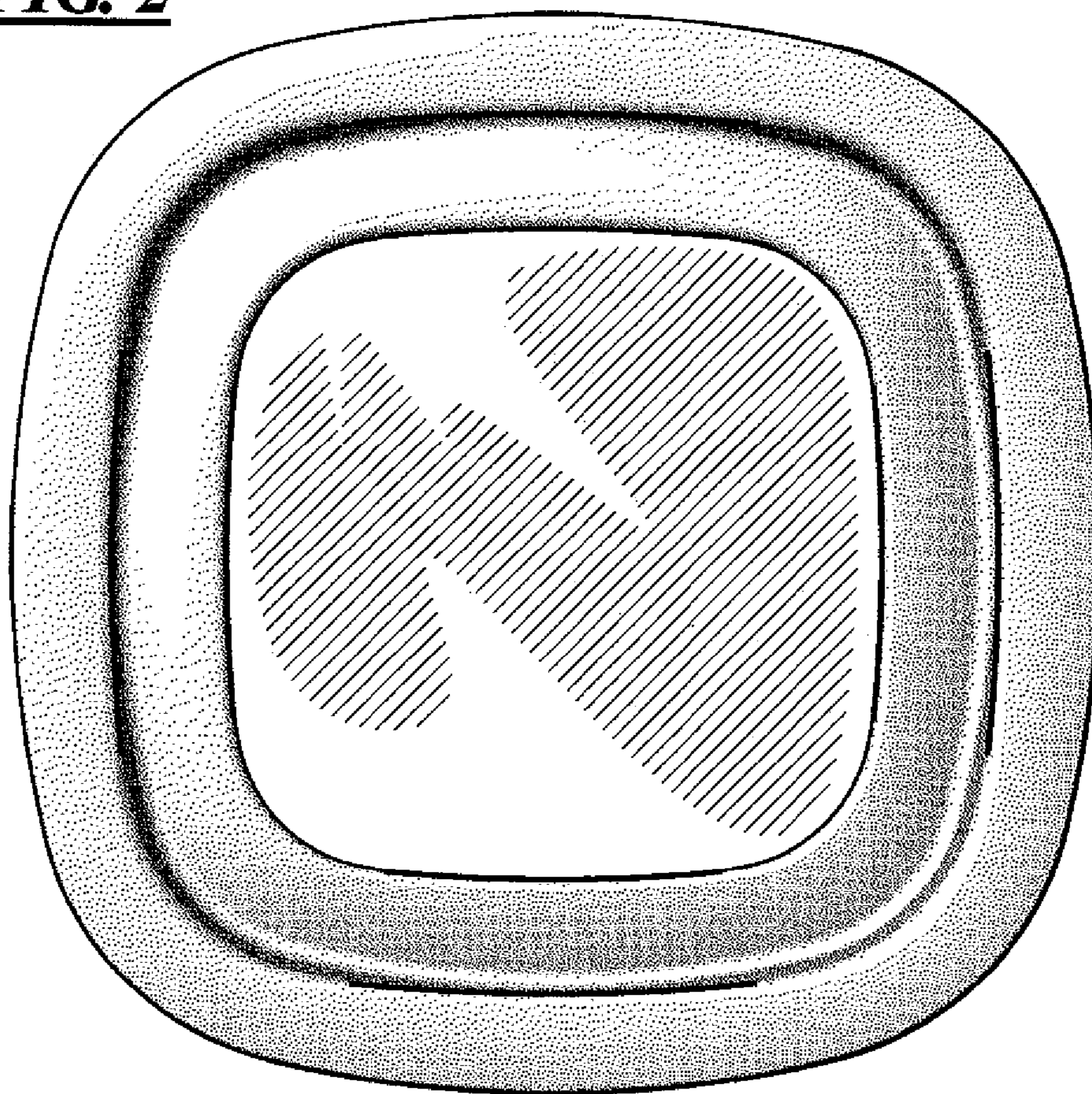

FIG. 3

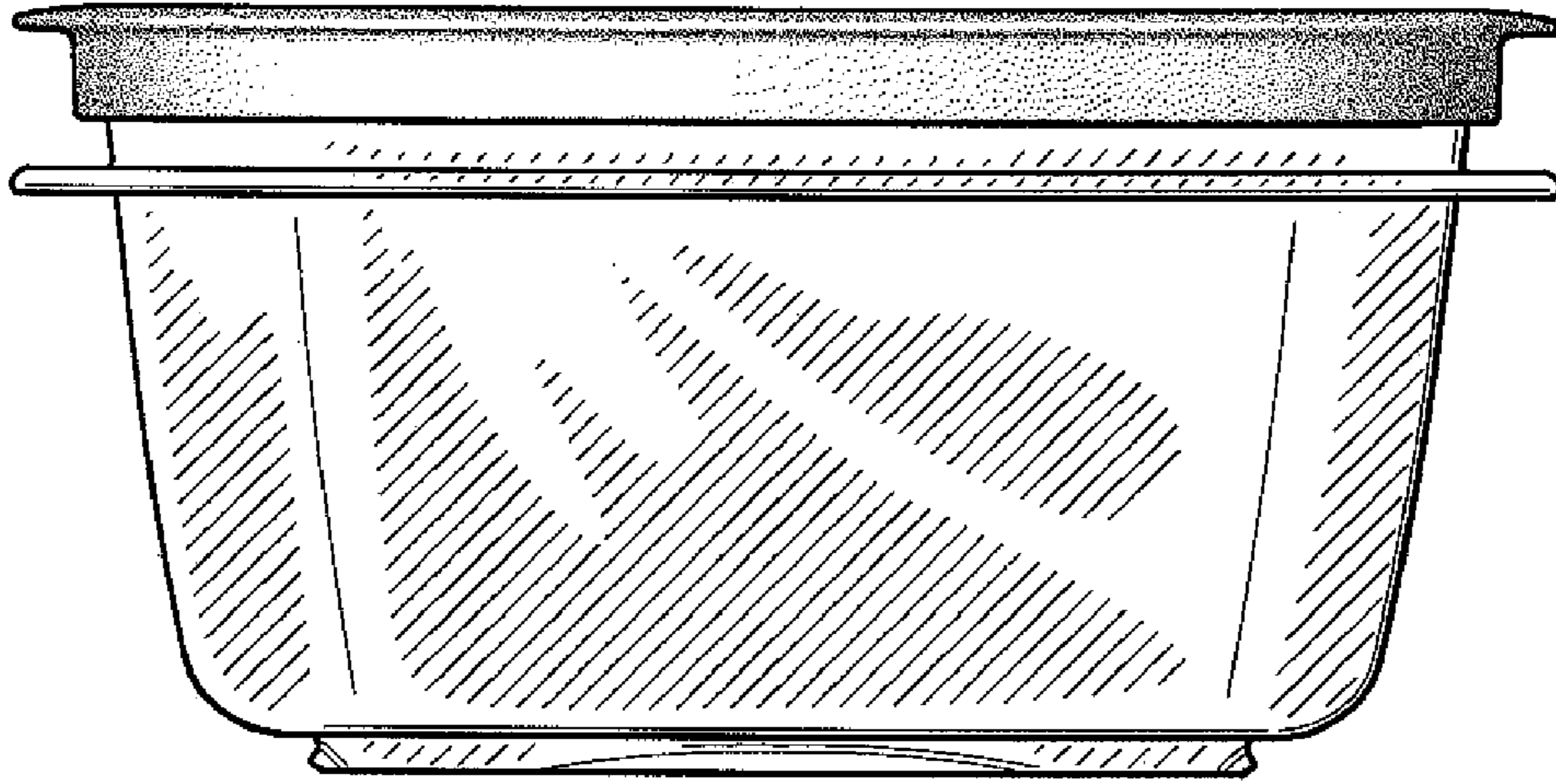

FIG. 4

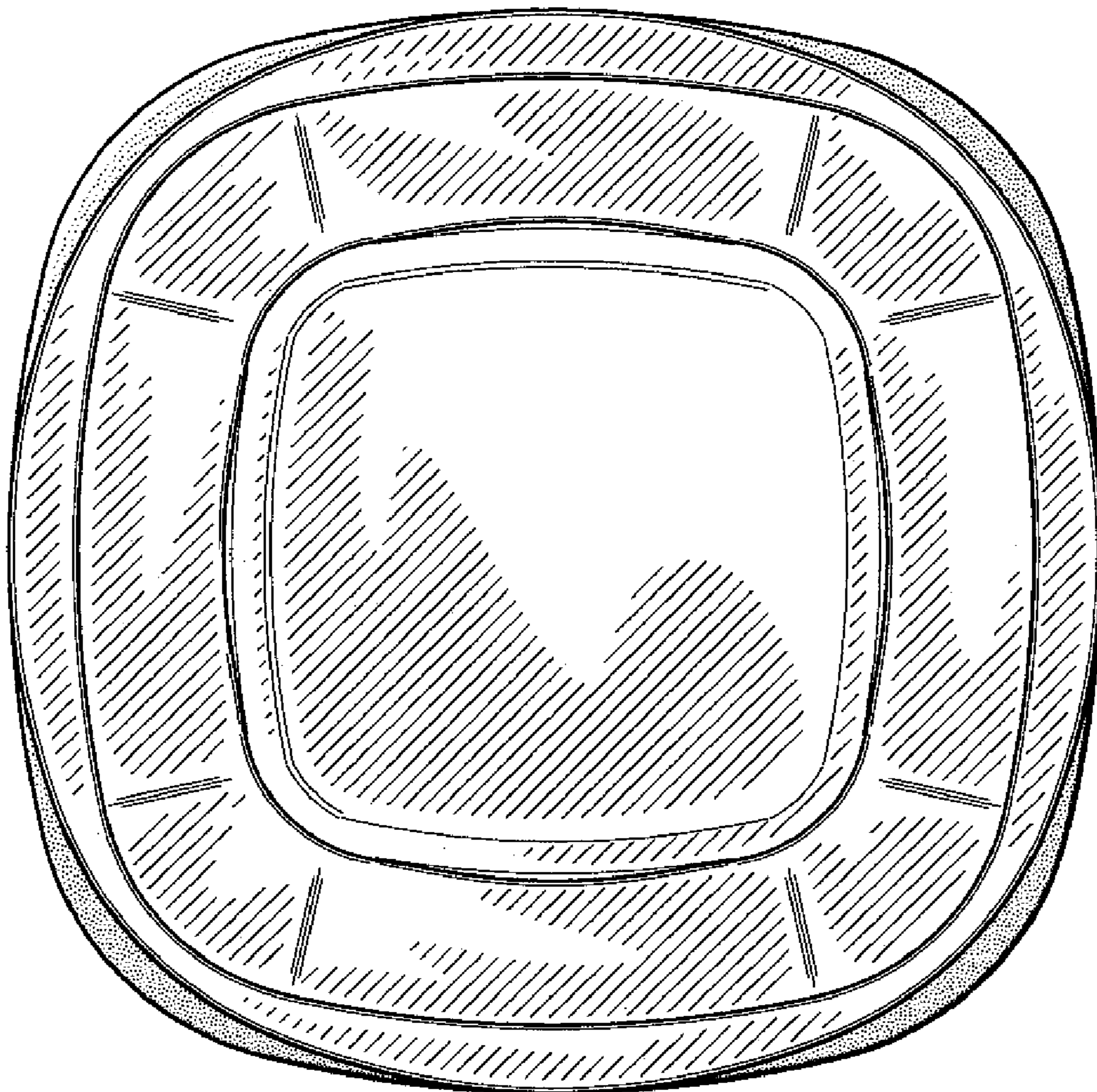

FIG. 5

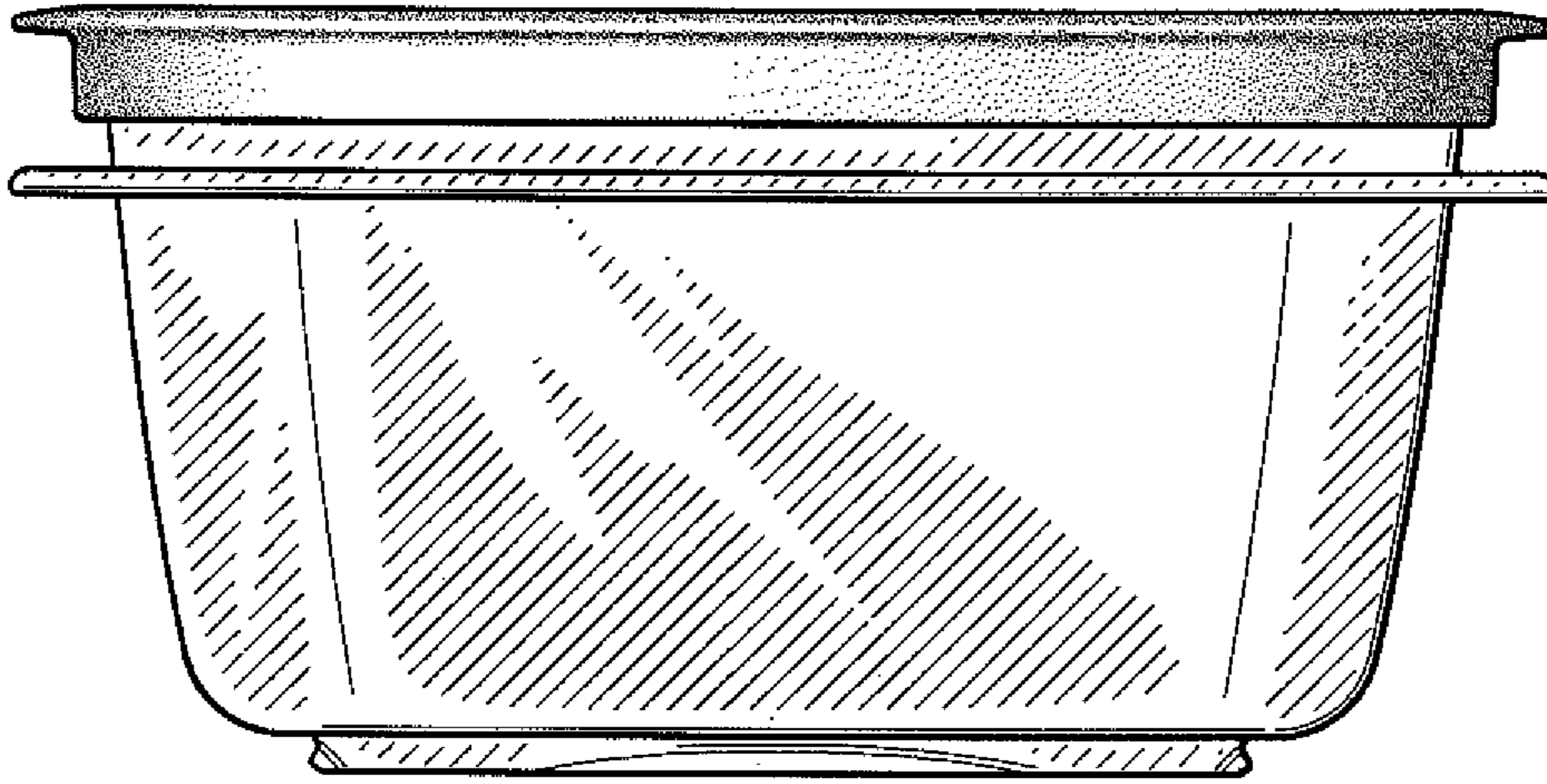

FIG. 6

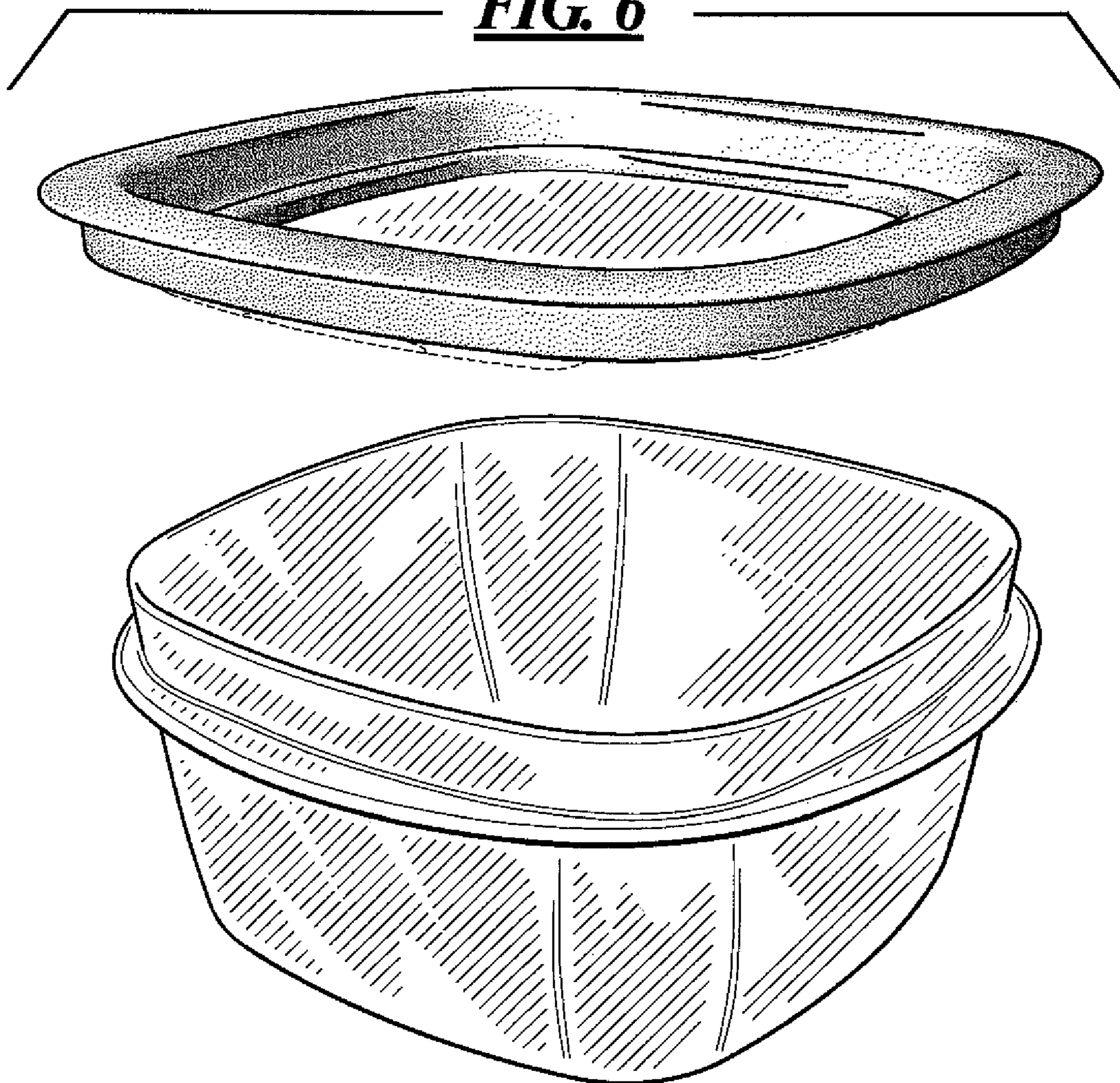

FIG. 7

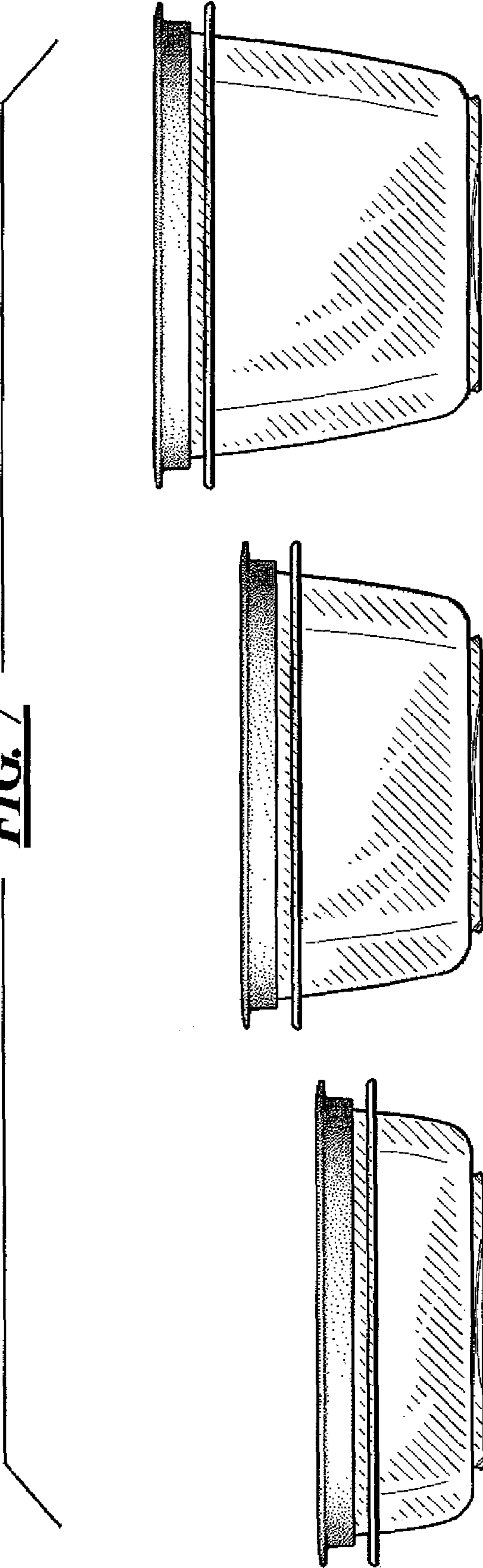

FIG. 8

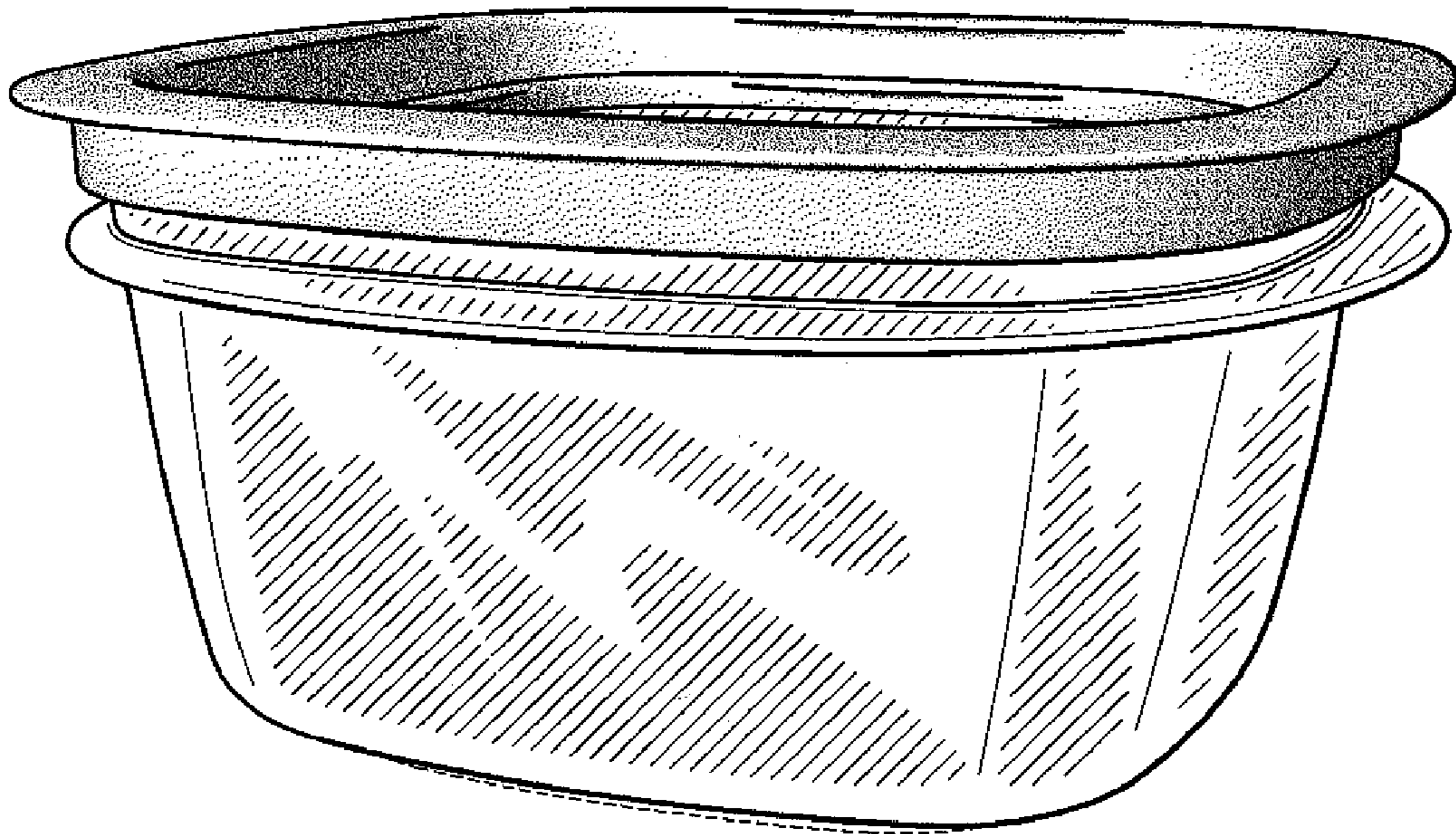

FIG. 9

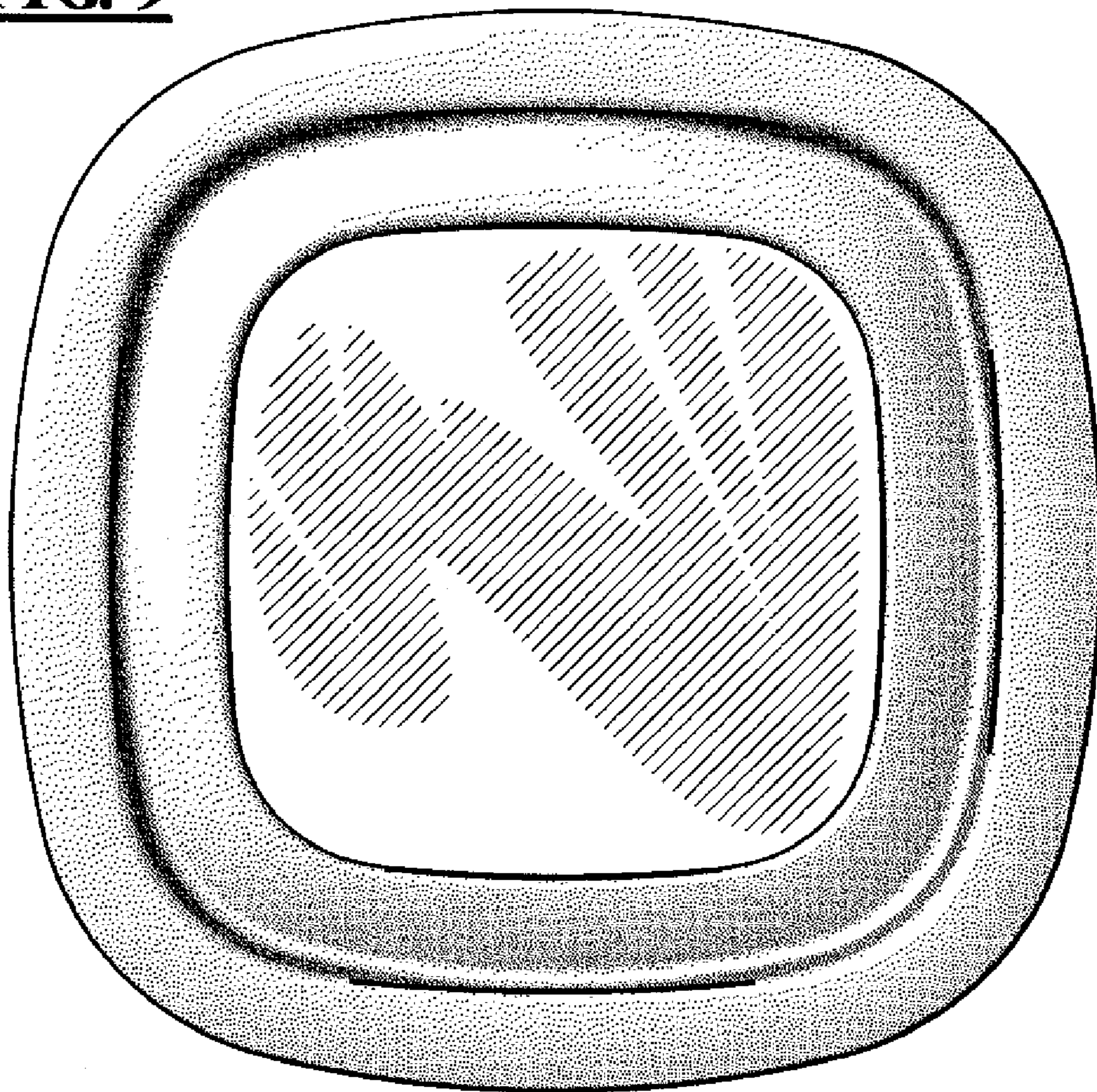

FIG. 10

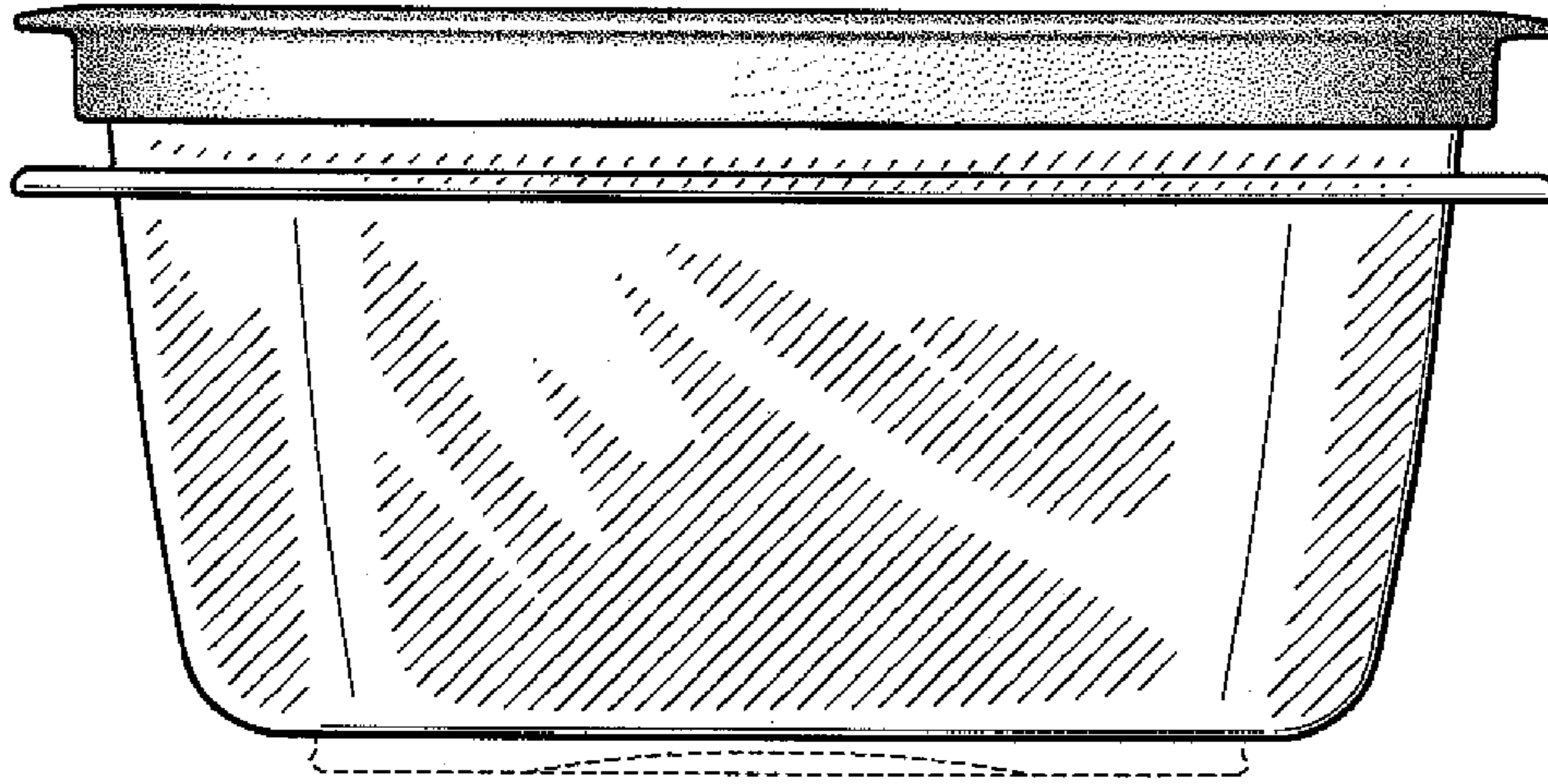

FIG. 11

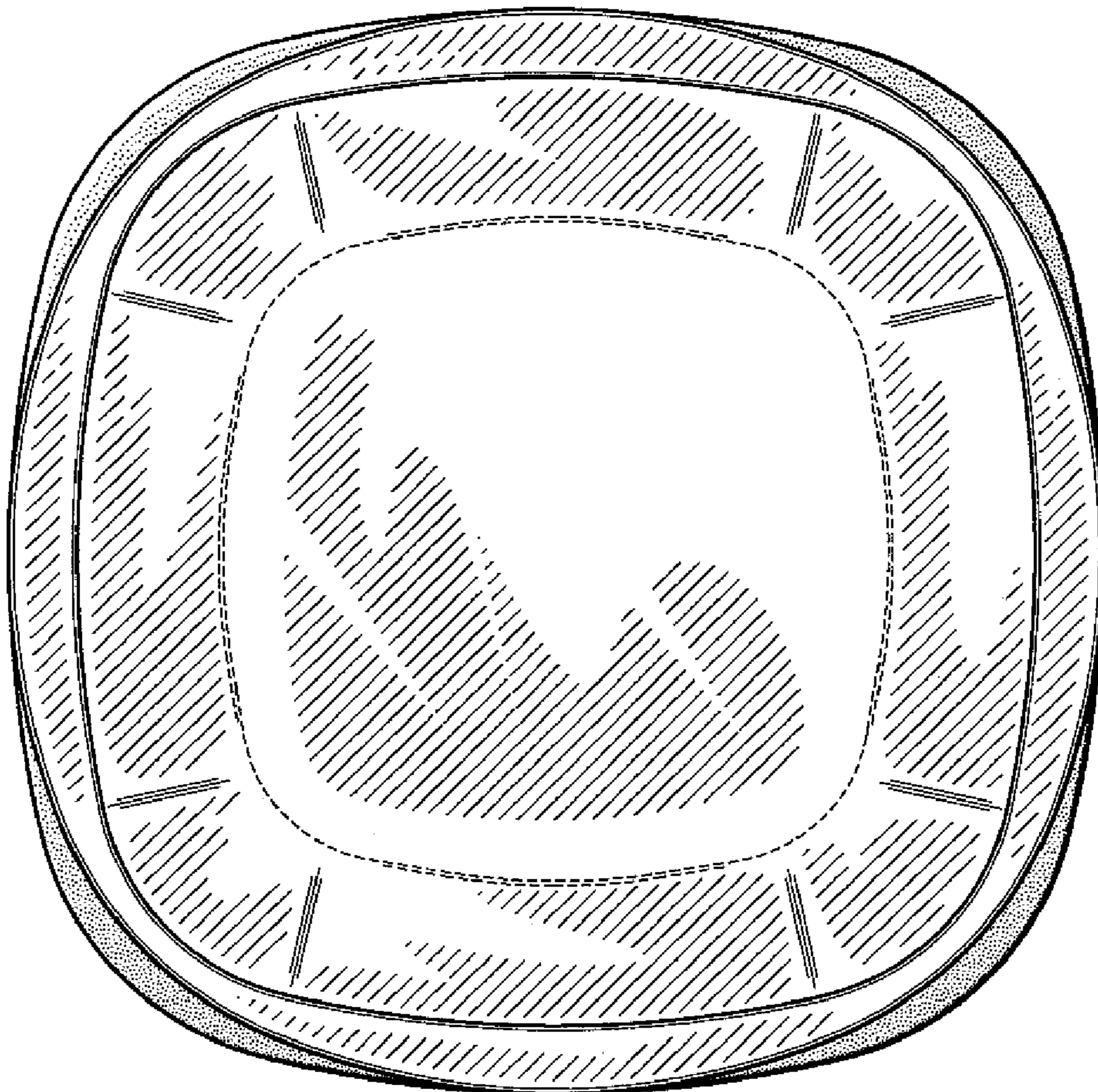

FIG. 12

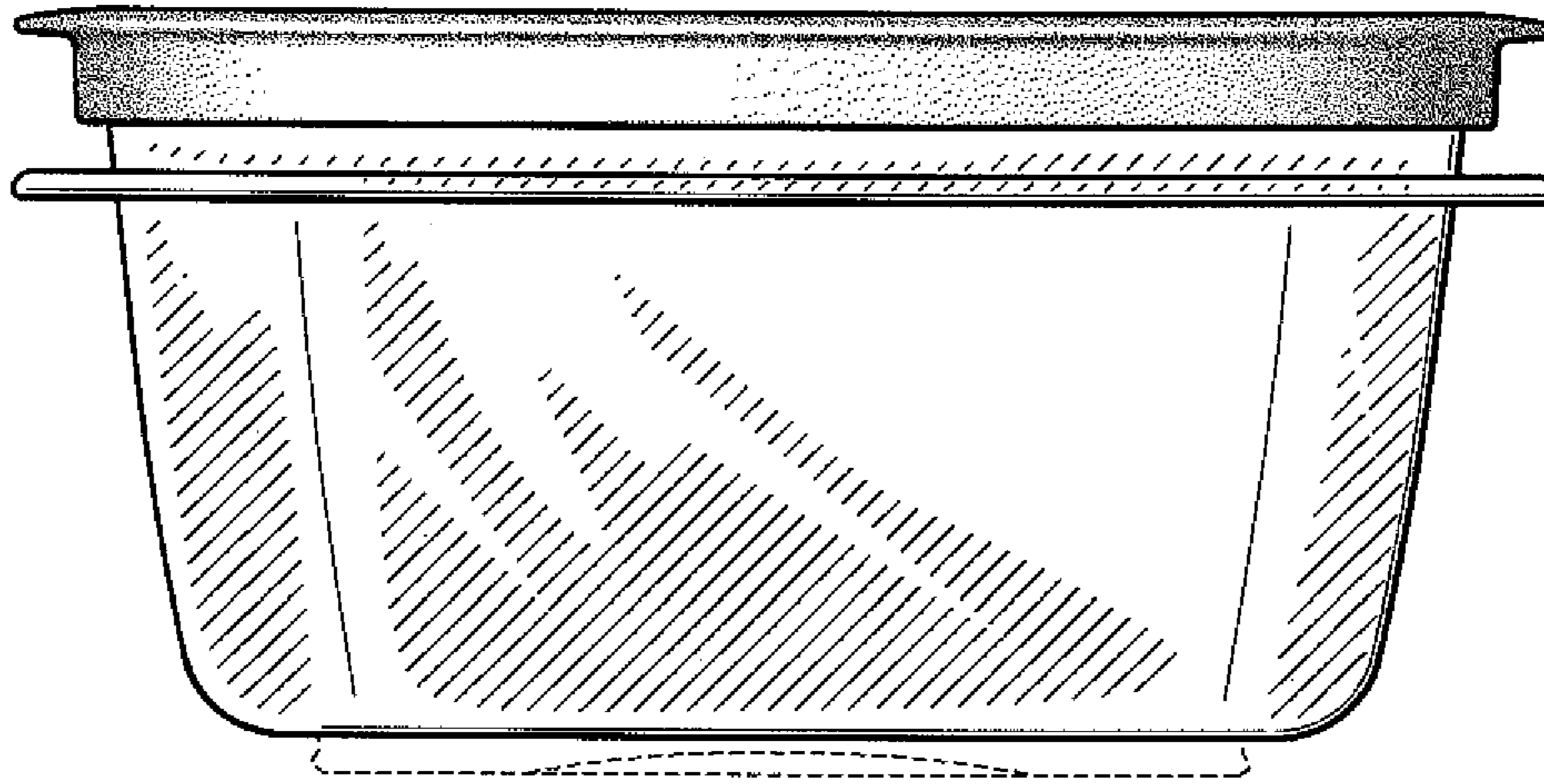

FIG. 13

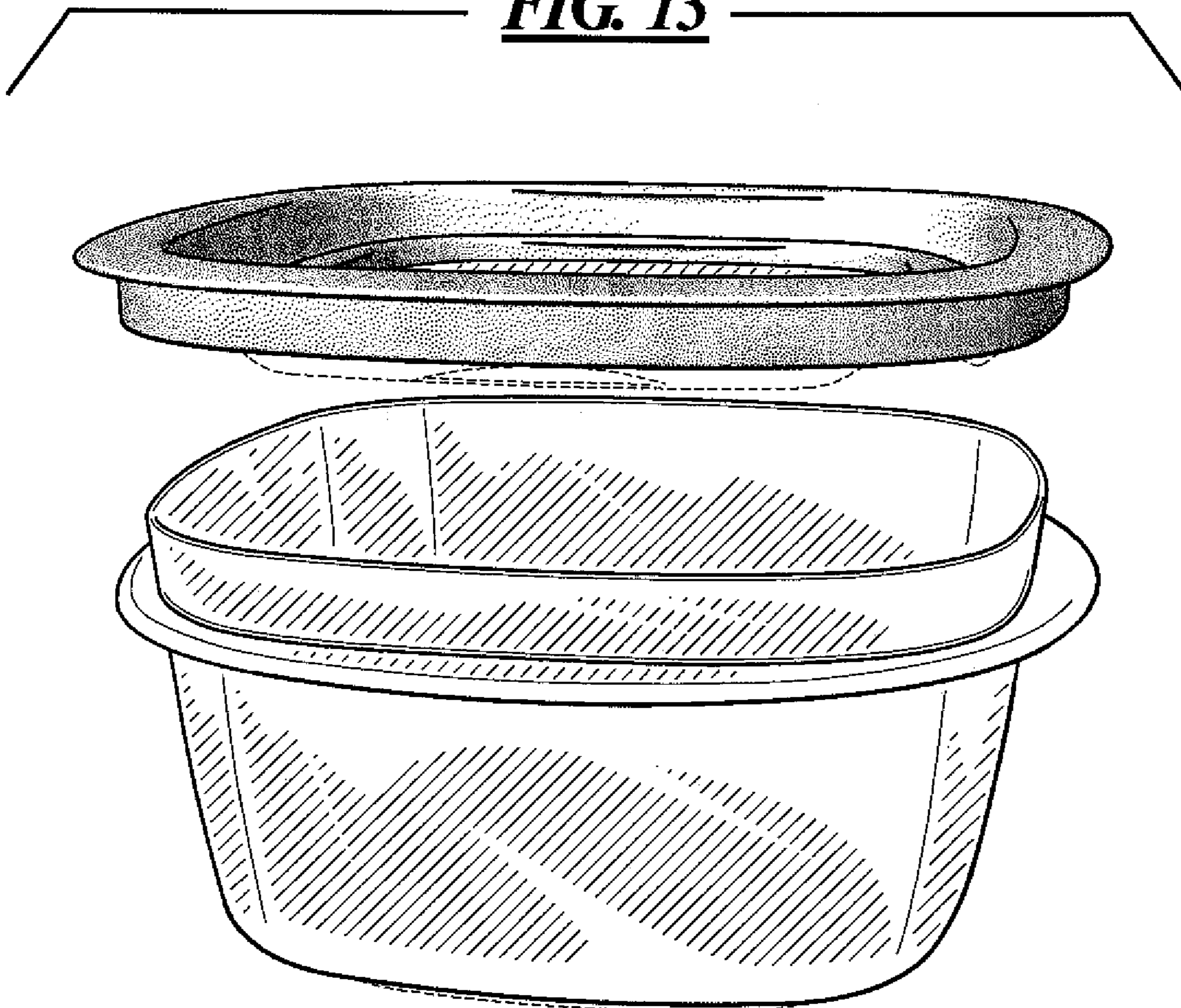

FIG. 14

