



US00D568573S

(12) **United States Design Patent**  
**Kamamoto et al.**

(10) **Patent No.:** **US D568,573 S**

(45) **Date of Patent:** **\*\* May 6, 2008**

(54) **LINKING PIN FOR POWER TRANSMITTING CHAIN**

(75) Inventors: **Shigeo Kamamoto**, Kashiwara (JP);  
**Joel Kuster**, Kashihara (JP); **Seiji Tada**, Kashiba (JP)

(73) Assignee: **JTEKT Corporation**, Osaka (JP)

(\*\*) Term: **14 Years**

(21) Appl. No.: **29/257,933**

(22) Filed: **Apr. 13, 2006**

(30) **Foreign Application Priority Data**

Oct. 14, 2005 (JP) ..... D2005-030003

(51) **LOC (8) Cl.** ..... **12-05**

(52) **U.S. Cl.** ..... **D34/35; D34/29**

(58) **Field of Classification Search** ..... D34/29,  
D34/35; 198/851, 838, 853, 850; 474/212;  
D25/119, 121, 122, 124, 126, 133, 136, 38,  
D25/164; 256/59, 65; 52/287.1, 288.4,  
52/474, 475.1

See application file for complete search history.

(56) **References Cited**

**U.S. PATENT DOCUMENTS**

- 1,737,150 A \* 11/1929 Davis ..... 198/851
- 3,144,123 A \* 8/1964 Wiese ..... 198/711
- D232,914 S \* 9/1974 Kaesler ..... D8/499
- D266,029 S \* 8/1982 Fujisawa ..... D34/29
- 4,764,158 A \* 8/1988 Honda et al. .... 474/212
- D306,490 S \* 3/1990 Reisinger et al. .... D25/124
- 4,989,724 A \* 2/1991 Komotzki ..... 198/731
- 4,993,543 A \* 2/1991 Lapeyre ..... 198/834
- D381,174 S \* 7/1997 Stoll ..... D34/29
- D385,078 S \* 10/1997 Thom, Jr. .... D34/29
- D413,393 S \* 8/1999 Damratoski ..... D25/38
- D420,149 S \* 2/2000 Hersh et al. .... D25/119
- 6,077,181 A \* 6/2000 Kanehira et al. .... 474/212

- 6,135,908 A \* 10/2000 Greiter ..... 474/215
- D437,428 S \* 2/2001 McMahon ..... D25/164
- D439,680 S \* 3/2001 Bennett ..... D25/164
- D448,494 S \* 9/2001 Williams ..... D25/119
- D449,416 S \* 10/2001 Horie et al. .... D34/35
- 6,387,003 B2 \* 5/2002 Horie et al. .... 474/215
- D516,103 S \* 2/2006 DeTemple et al. .... D15/138
- 7,137,504 B2 \* 11/2006 Ozaki et al. .... 198/779

\* cited by examiner

*Primary Examiner*—Cynthia E Ramirez

(74) *Attorney, Agent, or Firm*—Westerman, Hattori, Daniels & Adrian, LLP.

(57) **CLAIM**

The ornamental design for a linking pin for power transmitting chain, as shown and described.

**DESCRIPTION**

FIG. 1 is a front elevational view of a linking pin for power transmitting chain showing our new design;

FIG. 2 is a rear elevational view thereof;

FIG. 3 is a side view, with the other side being a mirror thereof;

FIG. 4 is a top view thereof;

FIG. 5 is cross-sectional view taken along lines A—A in FIG. 1;

FIG. 6 is a cross-sectional view taken along lines B—B in FIG. 1;

FIG. 7 is a cross-sectional view taken along lines C—C in FIG. 1;

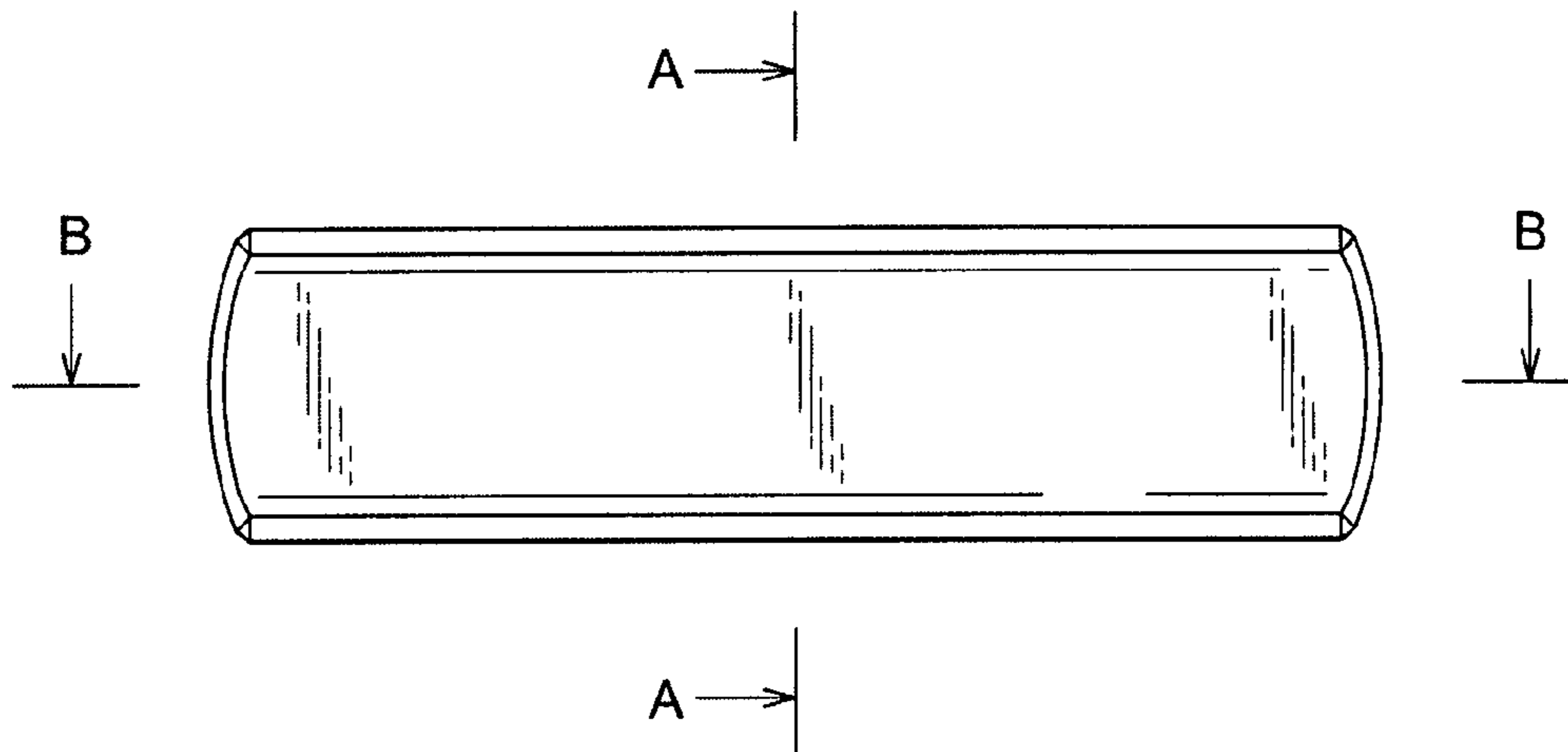
FIG. 8 is a front perspective view thereof;

FIG. 9 is a rear perspective view thereof; and,

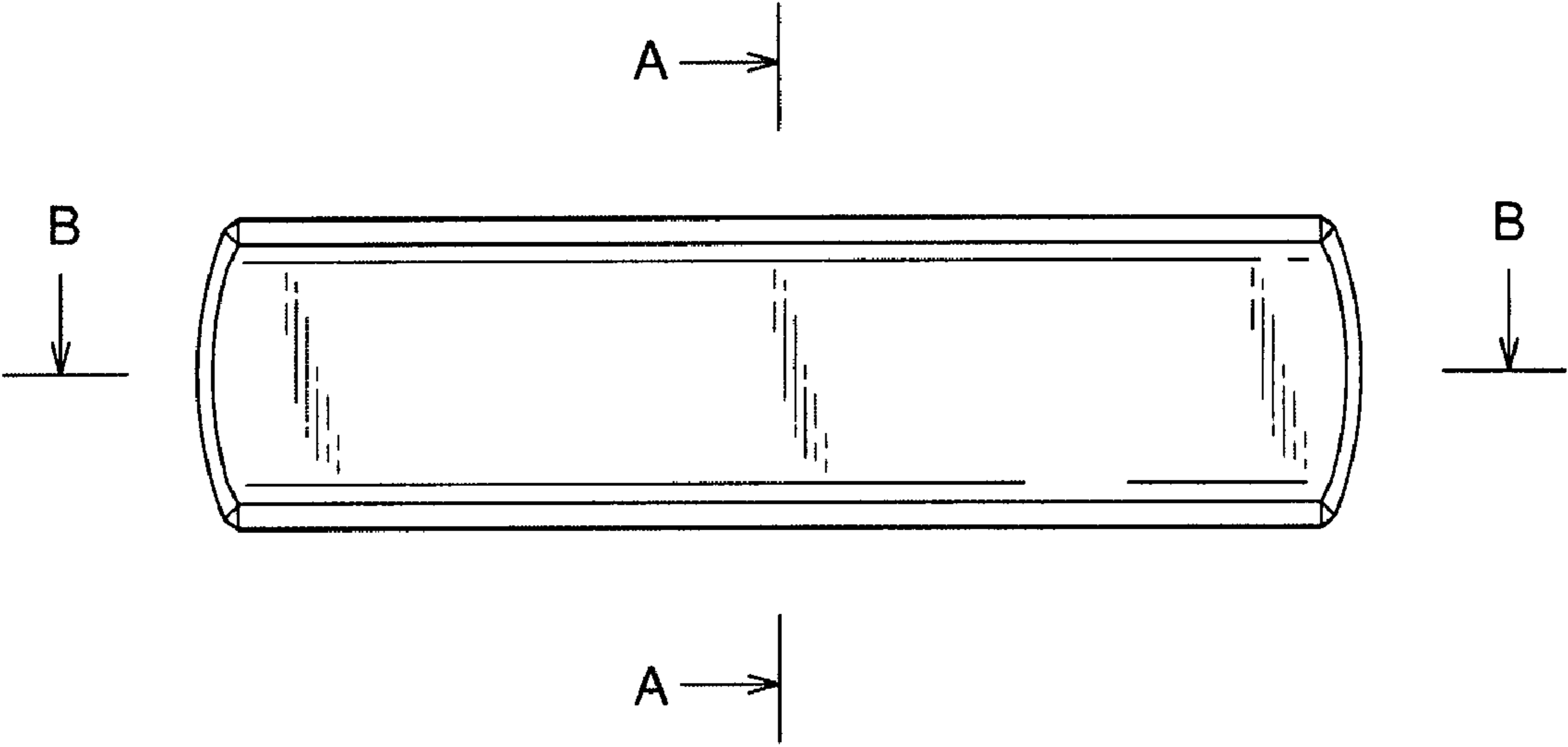
FIG. 10 is a reference view in use situation.

The broken lines show an environmental structure and do not form any part of the claimed design.

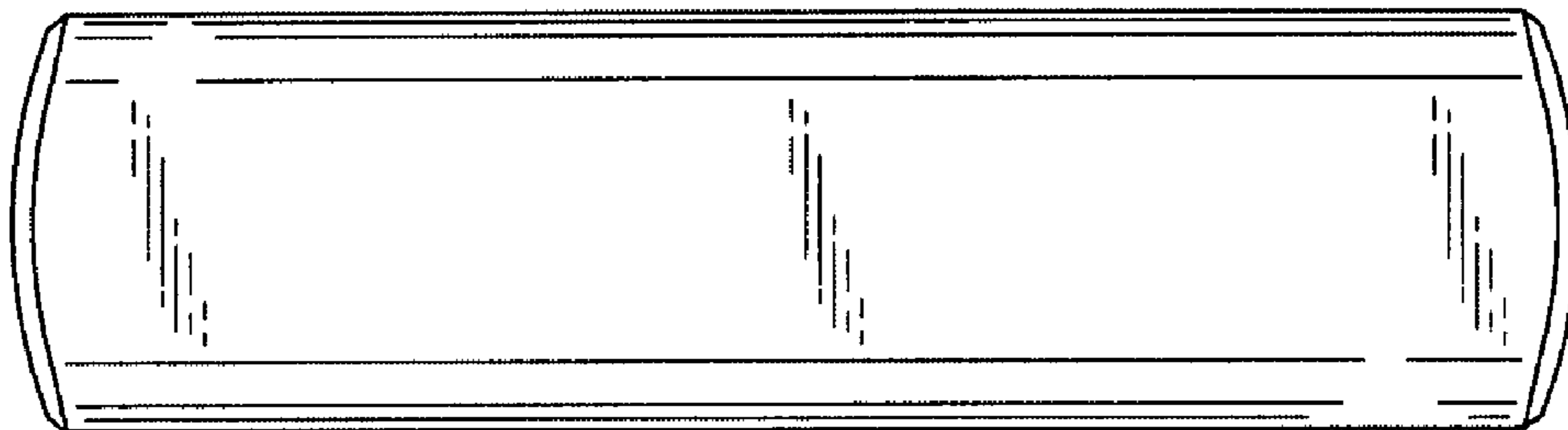
**1 Claim, 10 Drawing Sheets**



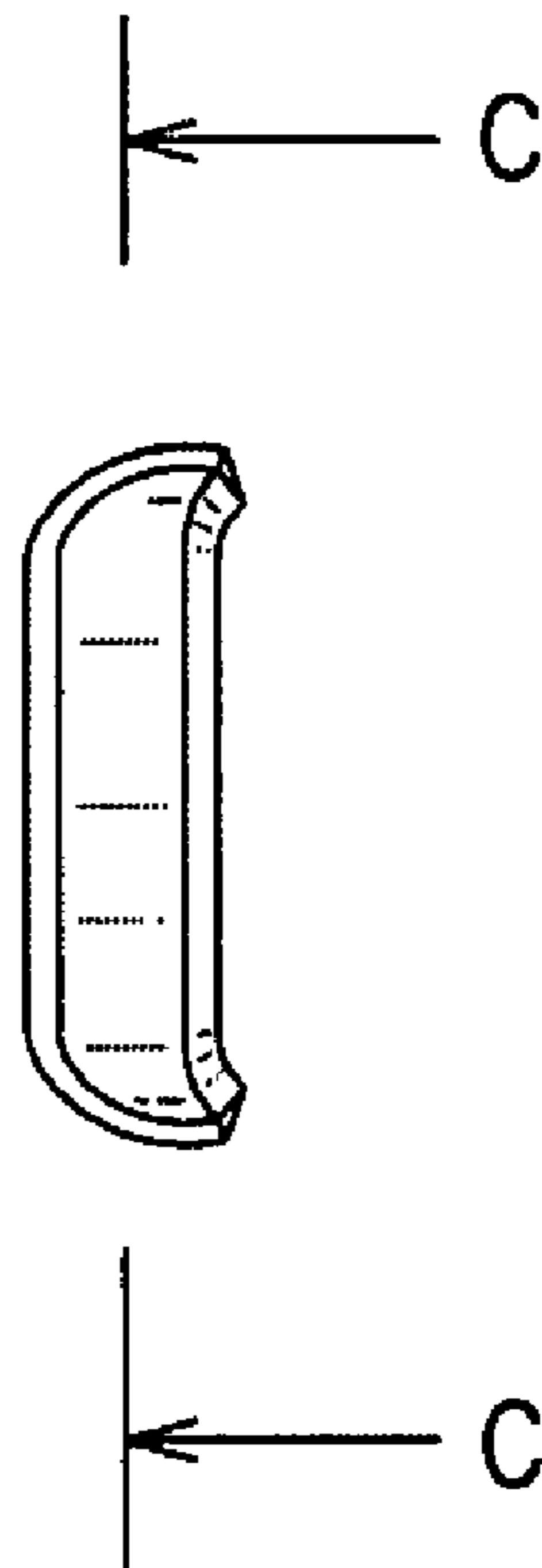
*Fig. 1*



*Fig. 2*



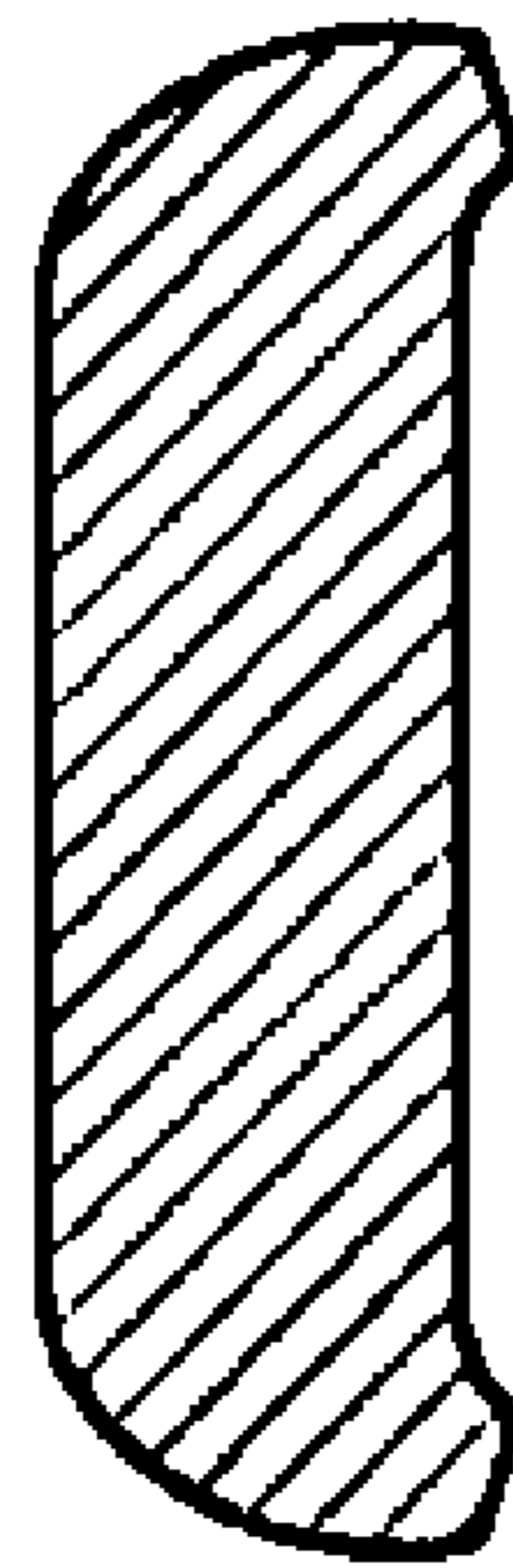
*Fig. 3*



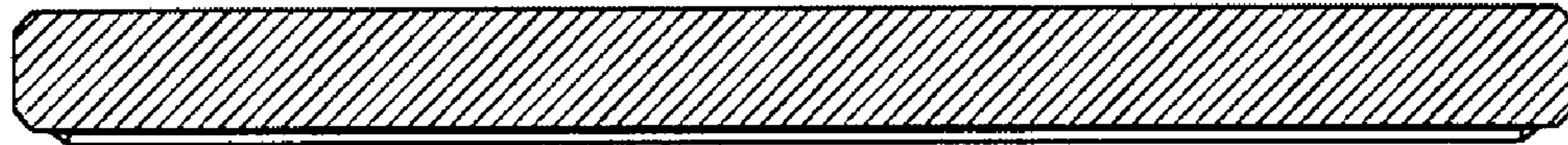
*Fig. 4*



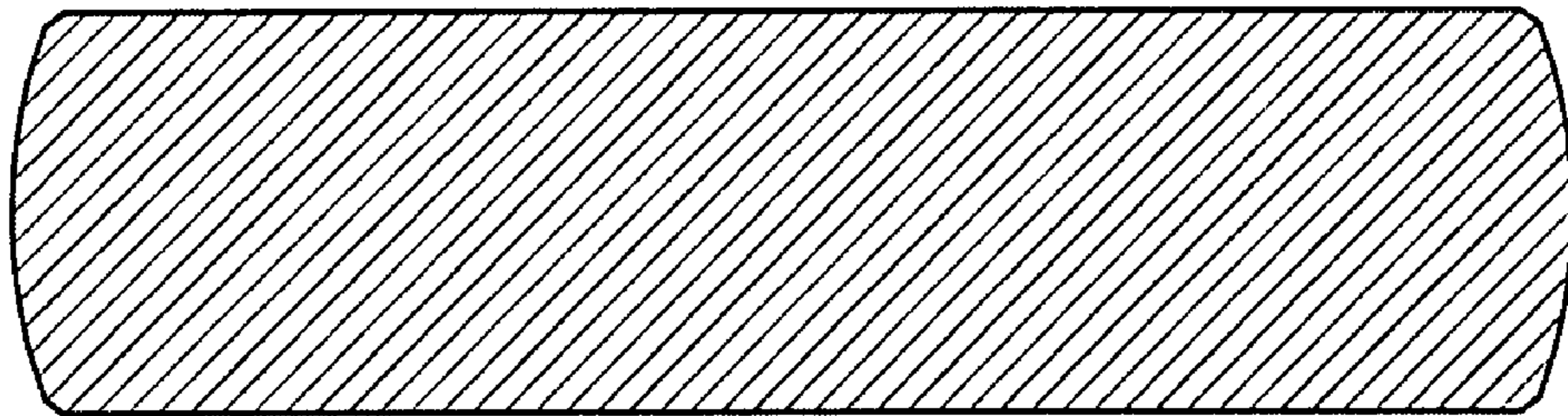
*Fig. 5*



*Fig. 6*

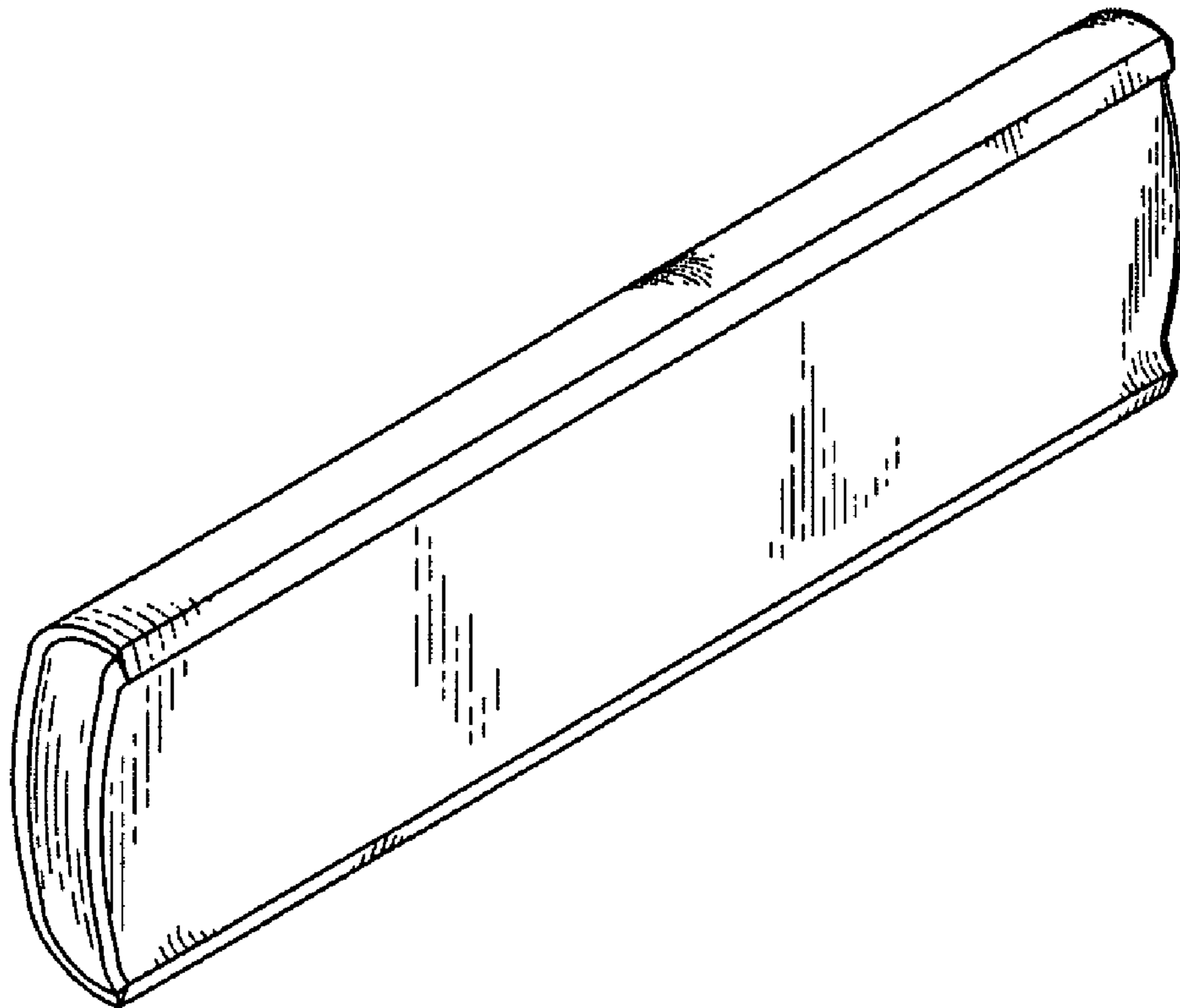


*Fig. 7*

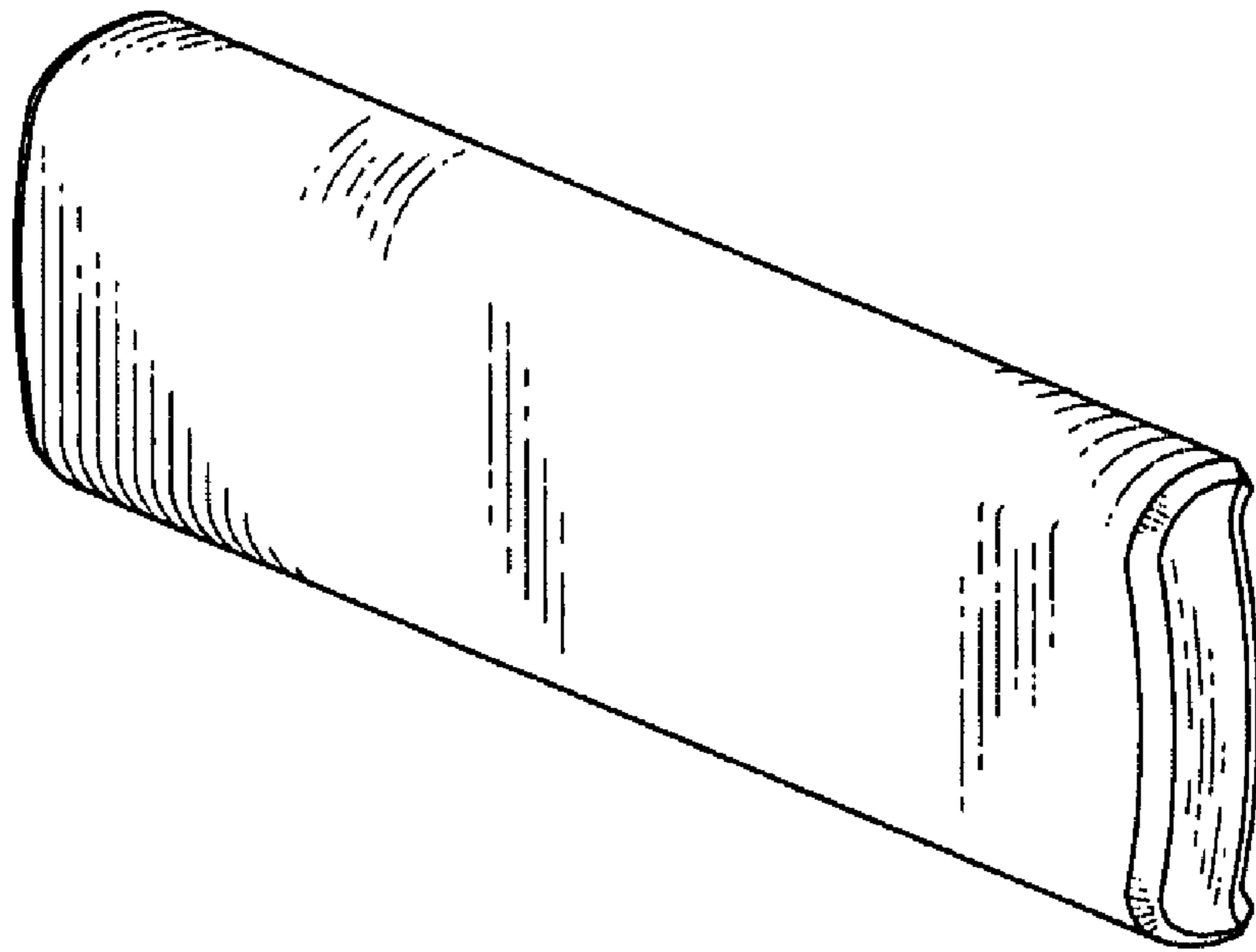




*Fig. 8*



*Fig. 9*



*Fig. 10*

