

US00D568496S

(12) **United States Design Patent**
Trabue et al.

(10) **Patent No.:** **US D568,496 S**

(45) **Date of Patent:** **** May 6, 2008**

(54) **CORNER MOLDING FOR WALL AND ROOF COVERINGS**

(75) Inventors: **Robert Trabue**, Hollywood, FL (US);
Stefan Schwarz, Coral Springs, FL (US)

(73) Assignee: **Nailite International**, Miami, FL (US)

(**) Term: **14 Years**

(21) Appl. No.: **29/272,272**

(22) Filed: **Feb. 5, 2007**

(51) **LOC (8) Cl.** **25-01**

(52) **U.S. Cl.** **D25/139; D25/102**

(58) **Field of Classification Search** D25/139,
D25/102, 136, 124, 199; 52/407.1, 406.1,
52/520, 406.2, 555, 406.3, 174, 320, 325,
52/407.2, 323, 532, 404.1, 374, 519, 287.1,
52/288.1

See application file for complete search history.

(56) **References Cited**

U.S. PATENT DOCUMENTS

D454,648 S * 3/2002 Shaw et al. D25/139

D456,089 S * 4/2002 Shaw et al. D25/139
D551,779 S * 9/2007 Swanson et al. D25/102
2001/0037617 A1* 11/2001 Chi 52/288.1
2001/0054266 A1* 12/2001 Bennett 52/312
2002/0121057 A1* 9/2002 Steffes et al. 52/287.1

* cited by examiner

Primary Examiner—Catherine R. Oliver

(74) *Attorney, Agent, or Firm*—Leydig, Voit & Mayer, Ltd.

(57) **CLAIM**

The ornamental design for a corner molding for wall and roof coverings, as shown and described.

DESCRIPTION

FIG. 1 is a front elevational view of a corner molding embodying the design of the present invention;

FIG. 2 is a right side elevational view of the corner molding, the left side elevational view being a mirror image.

FIG. 3 is a rear view perspective of the corner molding;

FIG. 4 is a front perspective of the corner molding;

FIG. 5 is a top plan view of the corner molding; and,

FIG. 6 is a bottom perspective of the corner molding.

1 Claim, 2 Drawing Sheets

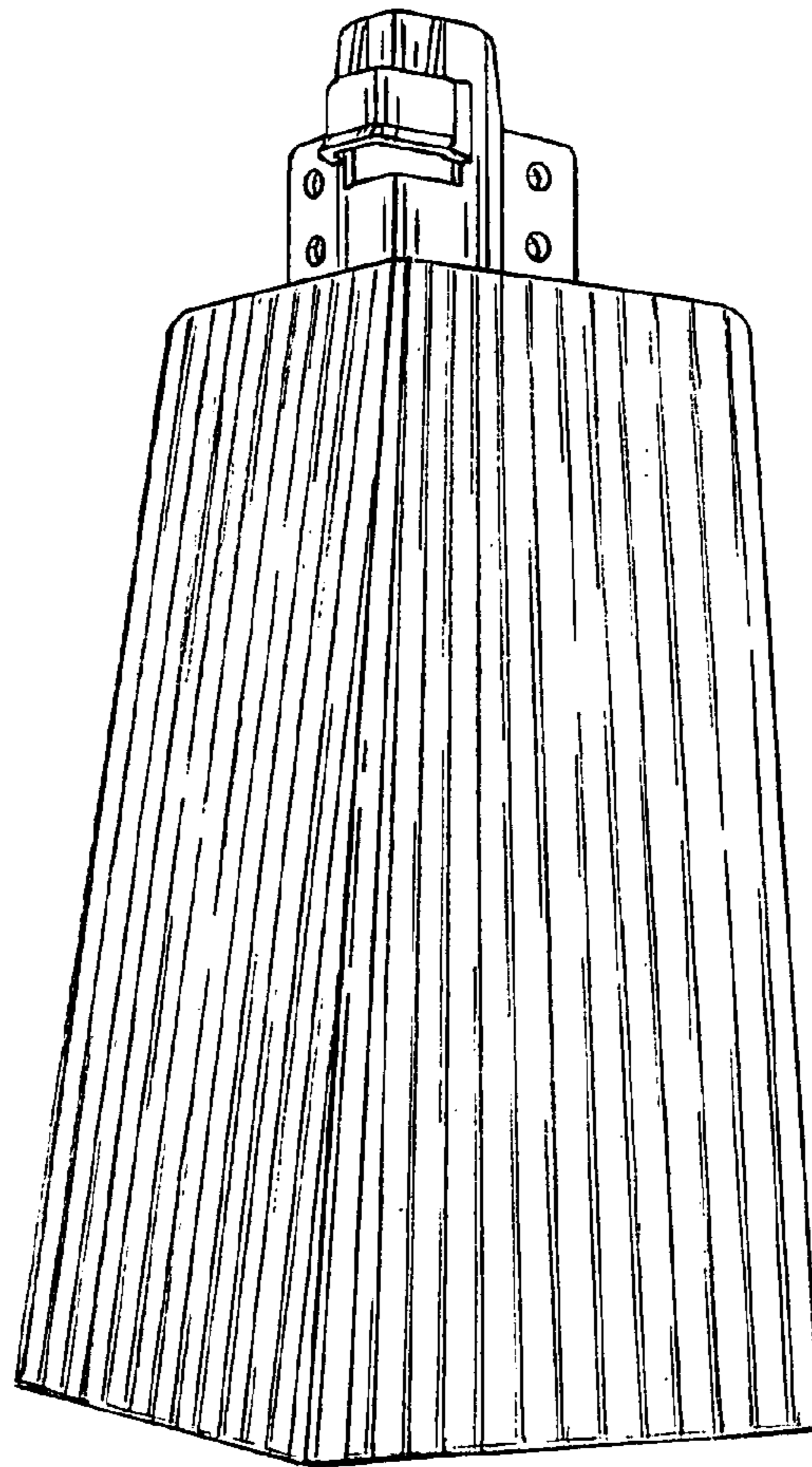

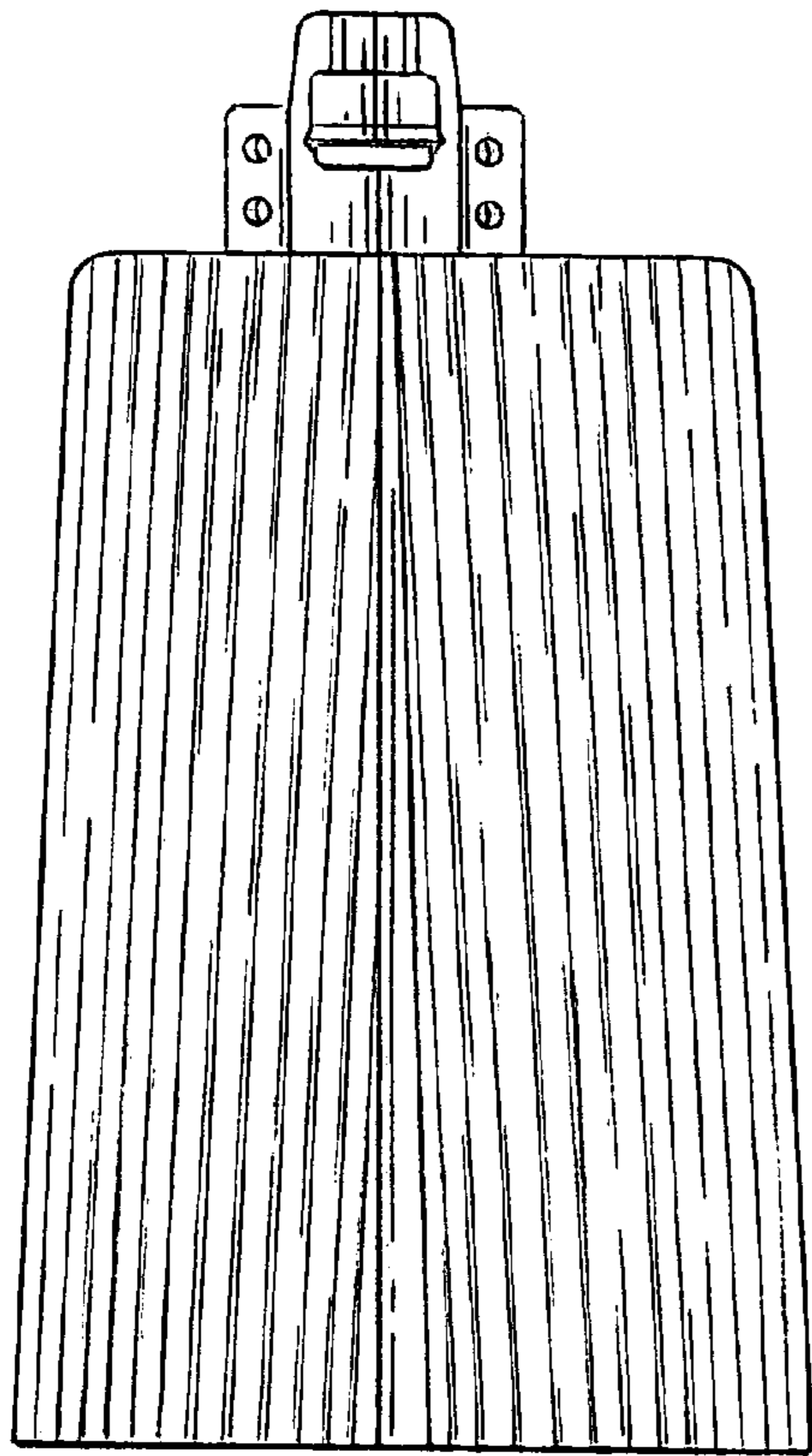

FIG. 1.

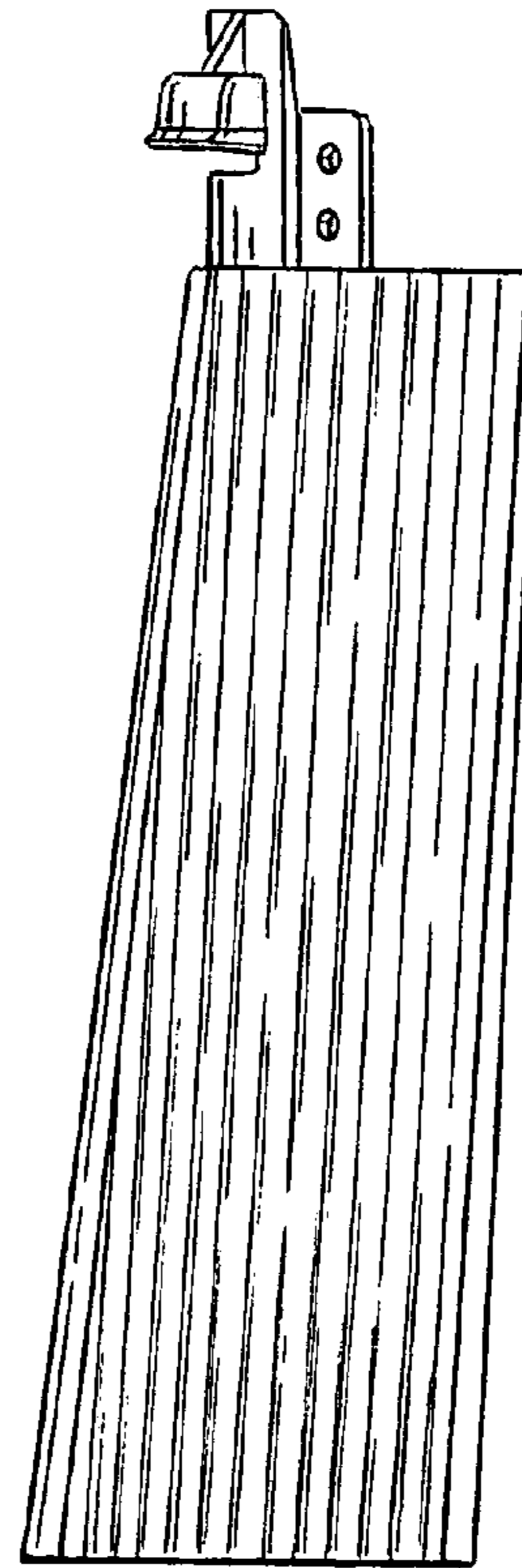

FIG. 2.

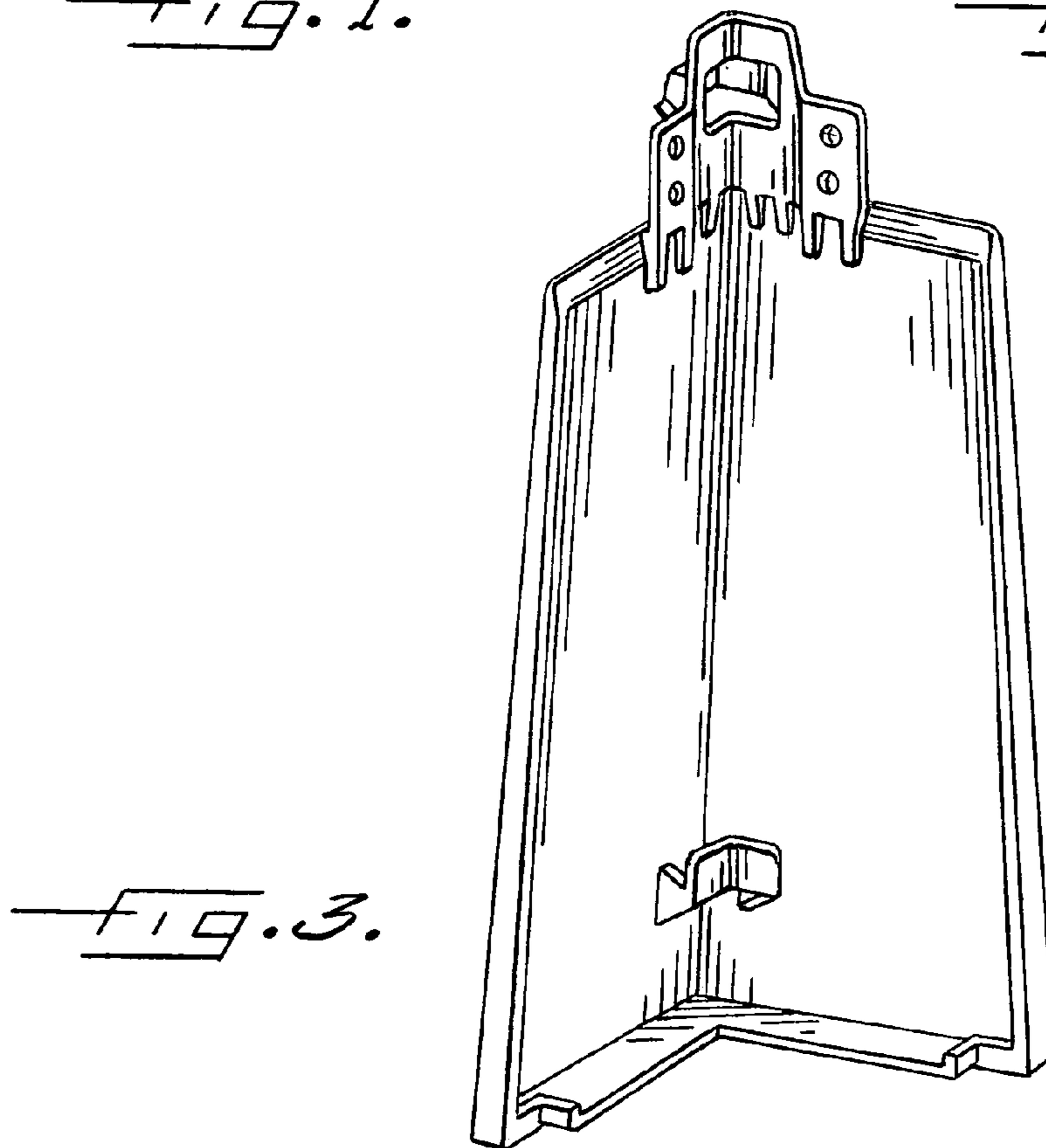

FIG. 3.

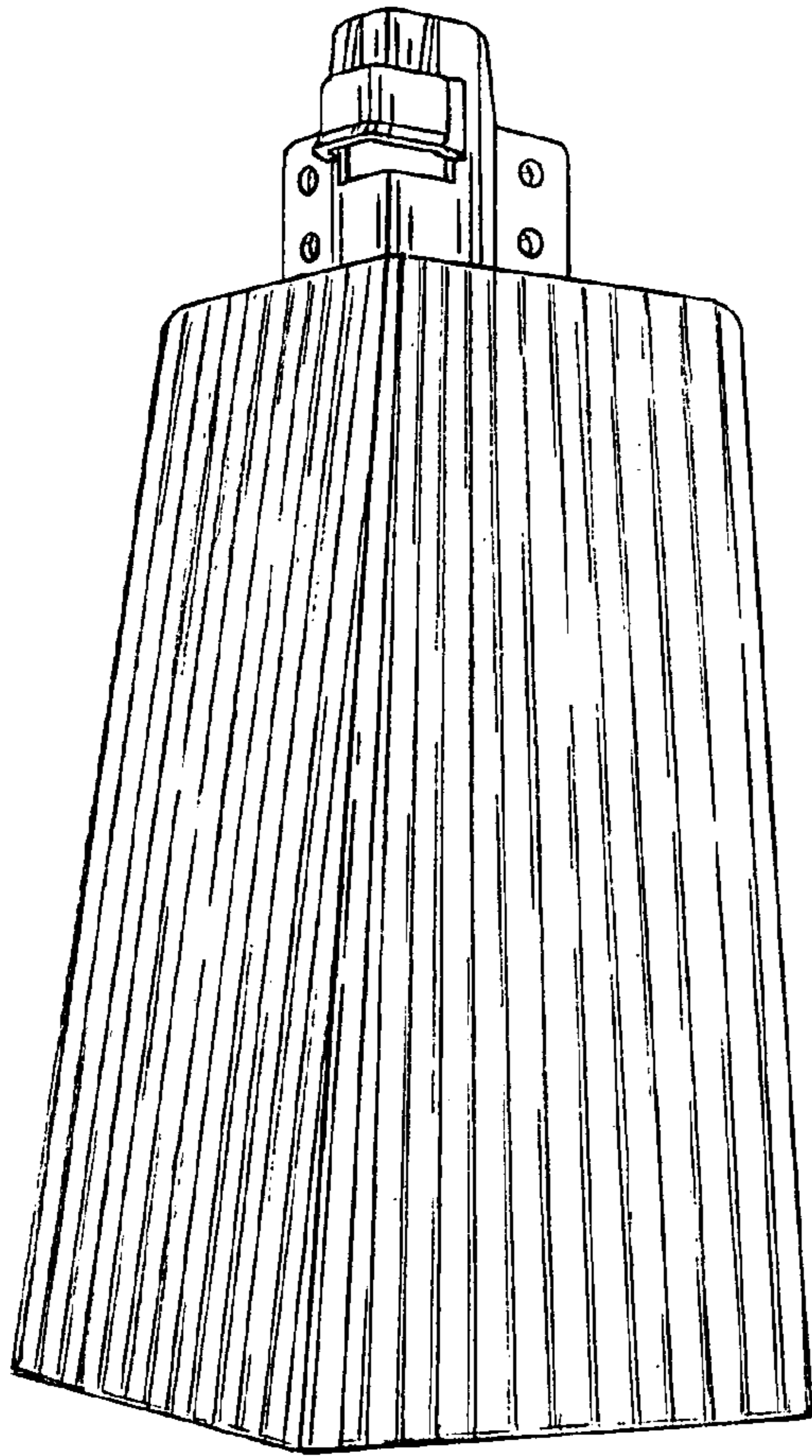

FIG. 4.

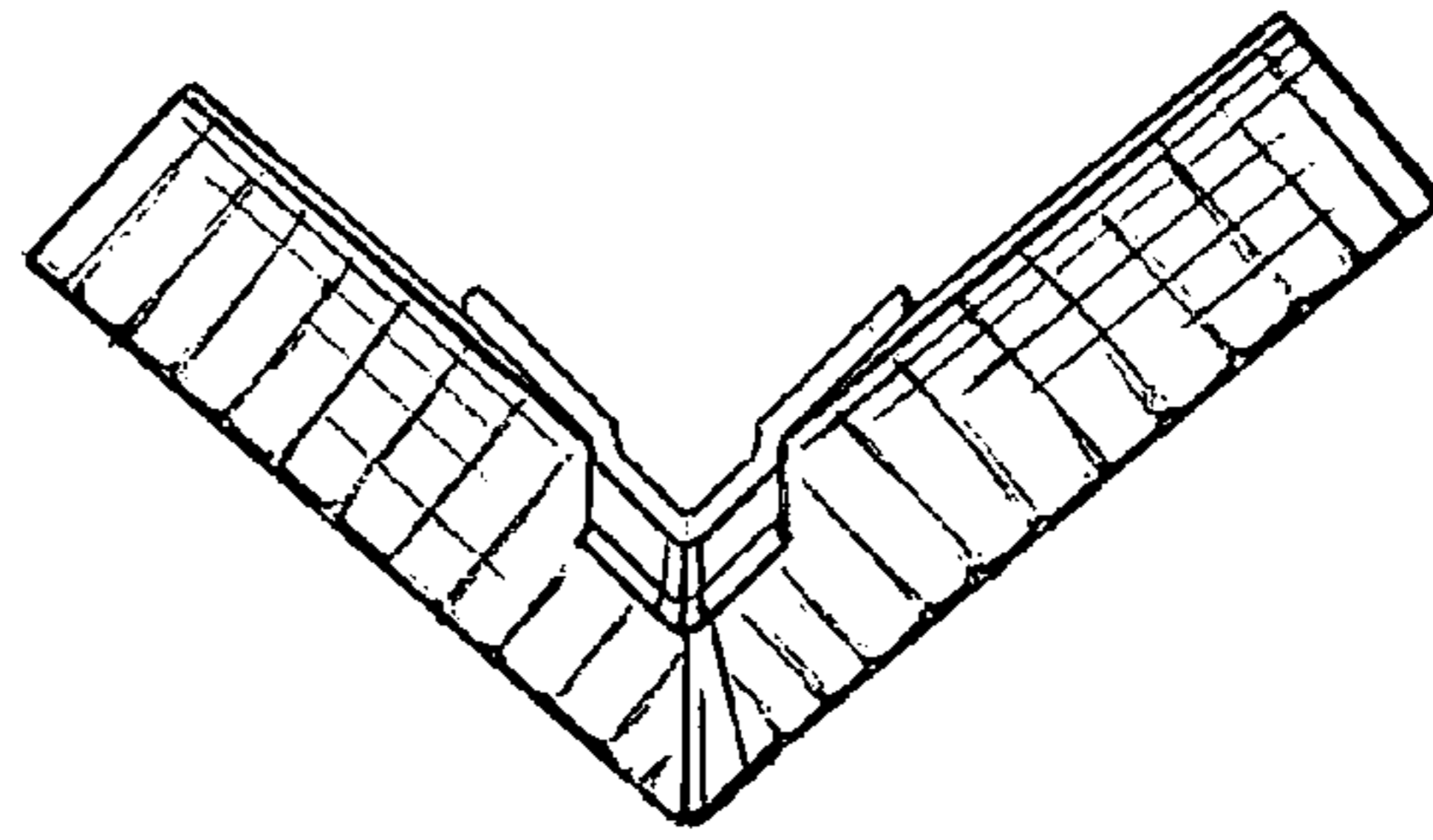

FIG. 5.

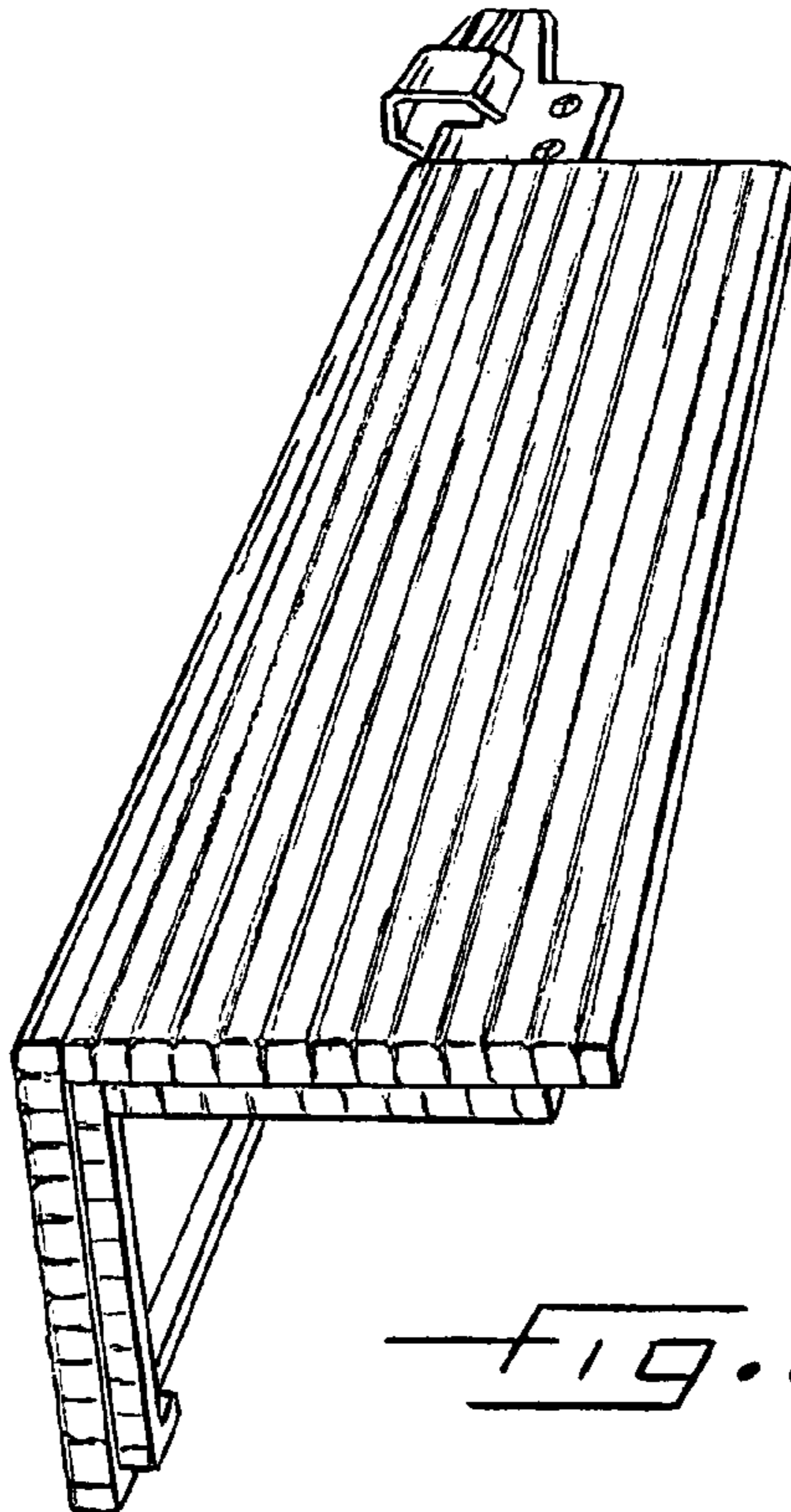

FIG. 6.