



US00D568313S

(12) **United States Design Patent**  
**Leung**

(10) **Patent No.:** **US D568,313 S**

(45) **Date of Patent:** **\*\* May 6, 2008**

(54) **USB MEMORY WITH LASER POINTER AND REMOTE CONTROL**

(75) Inventor: **Chun Fai Leung**, Kowloon (HK)

(73) Assignee: **P.S.L. Limited**, Kowloon (HK)

(\*\*) Term: **14 Years**

(21) Appl. No.: **29/278,850**

(22) Filed: **Apr. 12, 2007**

(51) **LOC (8) Cl.** ..... **14-02**

(52) **U.S. Cl.** ..... **D14/356; D26/38**

(58) **Field of Classification Search** ..... D14/436,  
D14/411, 384-385, 518, 348, 432-435, 299,  
D14/167, 402, 242, 356, 496, 156, 240, 218;  
439/518, 139, 141, 144, 140, 638; 365/63;  
710/74, 62; 361/684, 385-6; 257/315; D26/38  
See application file for complete search history.

(56) **References Cited**

**U.S. PATENT DOCUMENTS**

D322,609 S *	12/1991	Patton	.....	D14/218
D344,522 S *	2/1994	Taniguchi	.....	D14/218
D462,945 S *	9/2002	Skulley	.....	D14/218
D478,579 S *	8/2003	Sade	.....	D14/240
D491,922 S *	6/2004	Poulet	.....	D14/218
D495,076 S *	8/2004	Mandel	.....	D26/37
6,792,487 B2 *	9/2004	Kao	.....	710/74

6,979,210 B2 *	12/2005	Regen et al.	.....	439/131
D518,907 S *	4/2006	Leung	.....	D26/37
D531,334 S *	10/2006	Lin	.....	D26/37
D537,181 S *	2/2007	Chen et al.	.....	D26/37
2003/0132923 A1 *	7/2003	Hu	.....	345/179
2006/0250787 A1 *	11/2006	Ho et al.	.....	362/118

\* cited by examiner

*Primary Examiner*—Robin V. Webster  
*Assistant Examiner*—Karen E Kearney

(57) **CLAIM**

The ornamental design for a USB memory with laser pointer and remote control, as shown.

**DESCRIPTION**

FIG. 1 is a front elevational view of a USB memory with laser pointer and remote control showing my new design; FIG. 2 is a rear elevational view thereof; FIG. 3 is a top plan view thereof; FIG. 4 is a bottom plan view thereof; FIG. 5 is a right side view thereof; FIG. 6 is a left side view thereof; FIG. 7 is a perspective view thereof; and, FIG. 8 is a perspective view thereof with the USB detached.

**1 Claim, 3 Drawing Sheets**

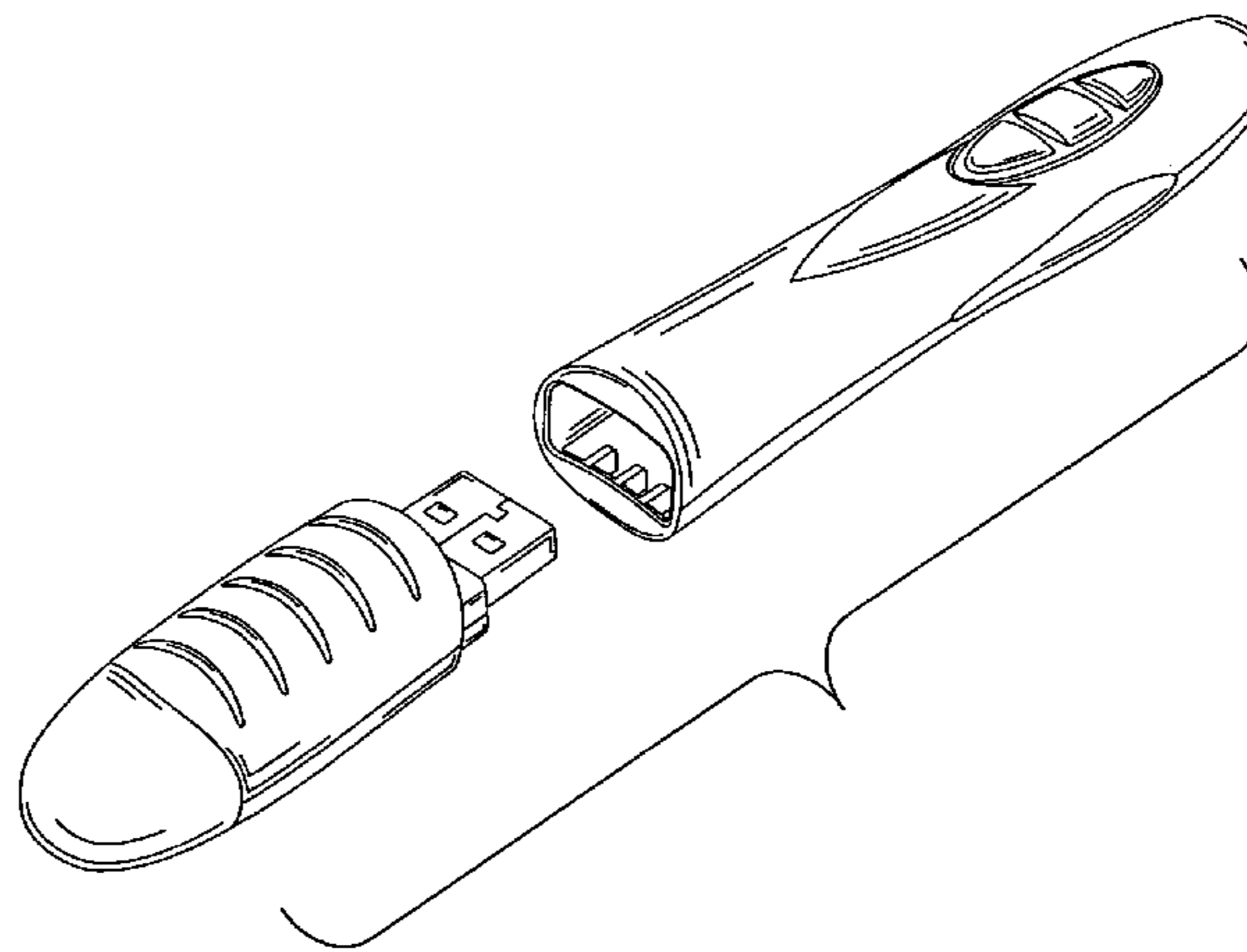
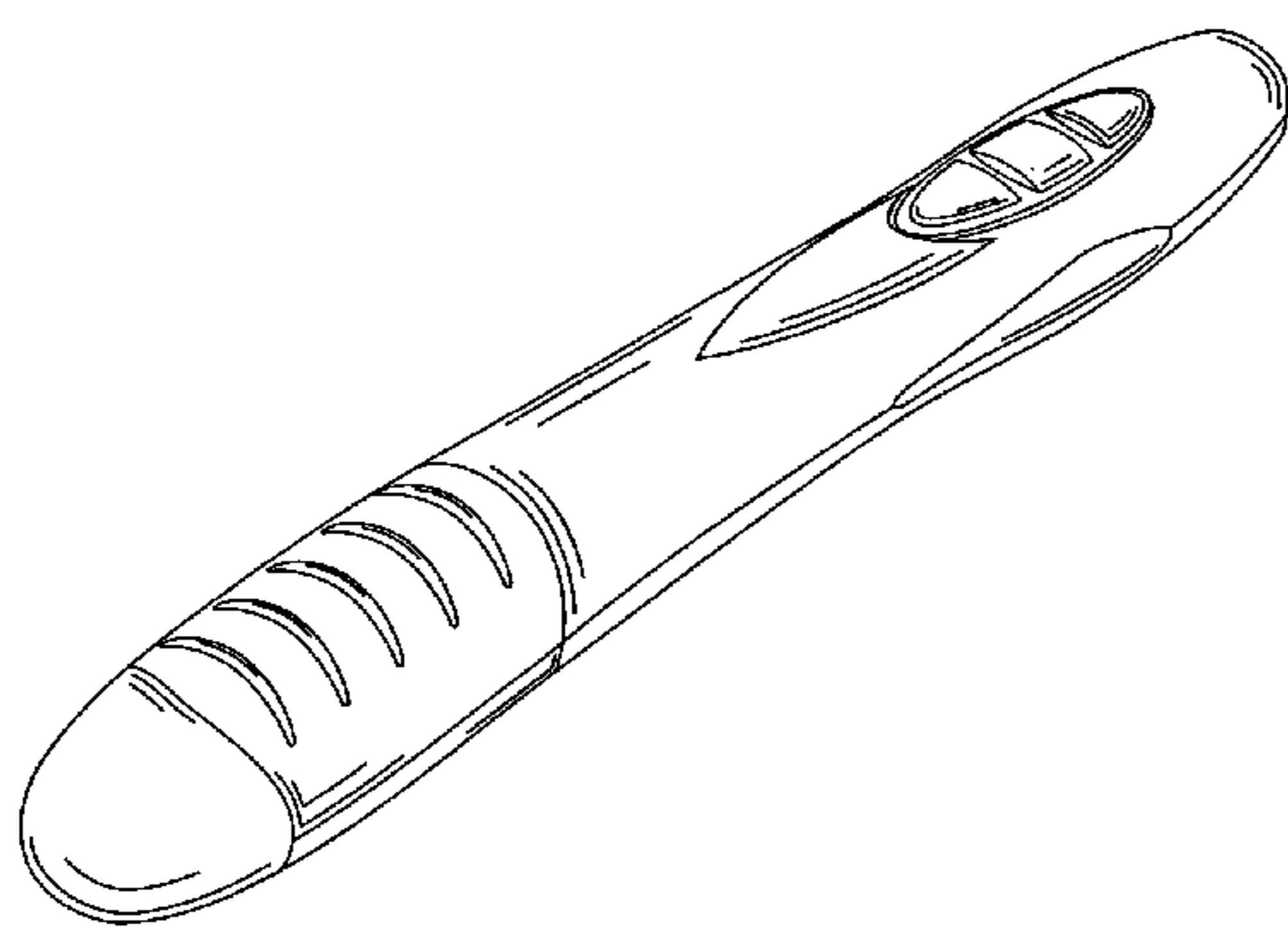

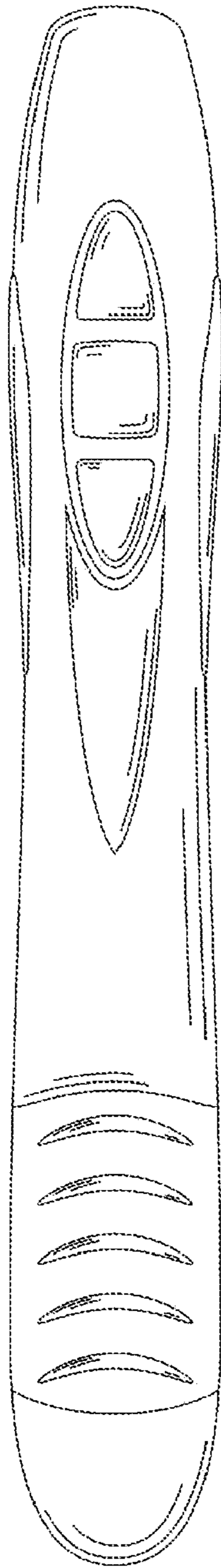

FIG. 1

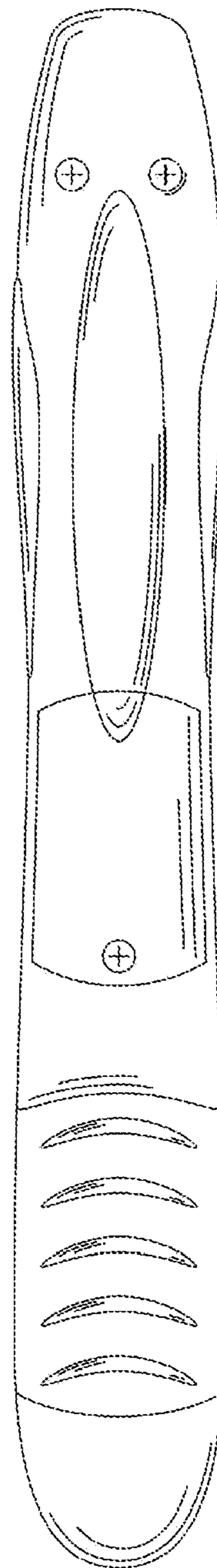

FIG. 2

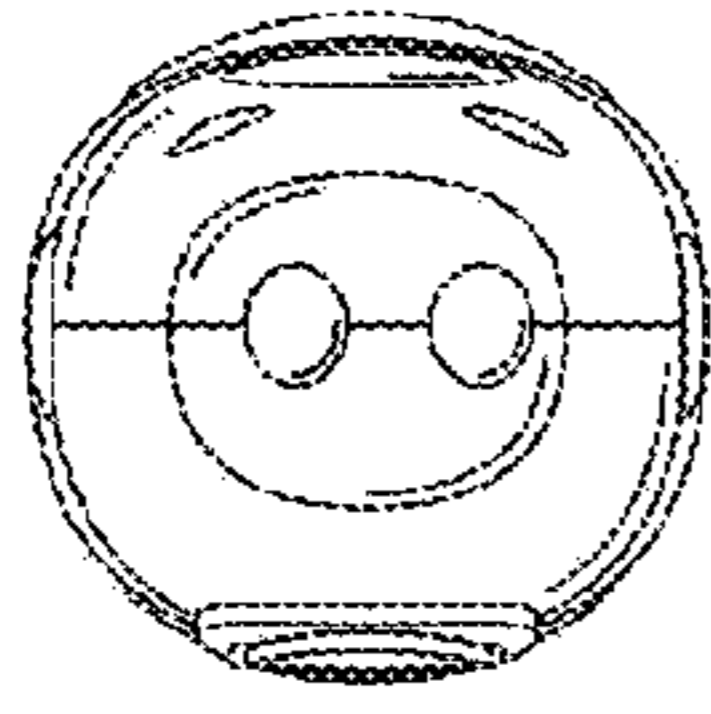

FIG. 3

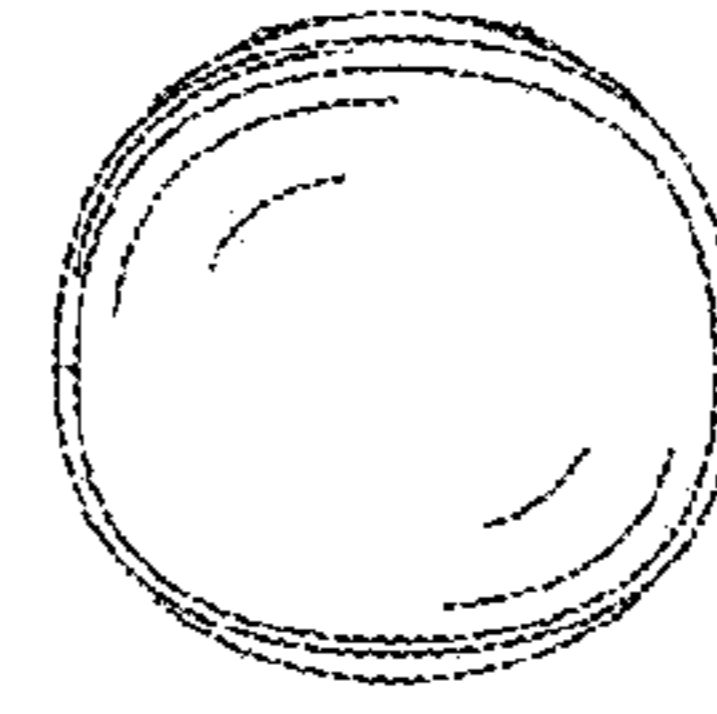

FIG. 4

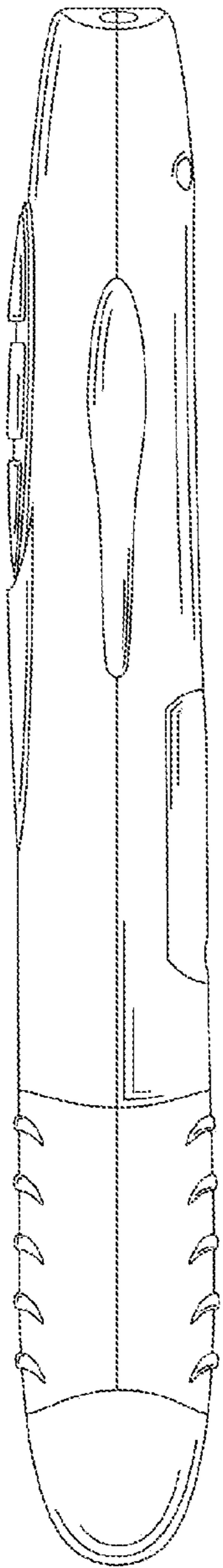

FIG. 5

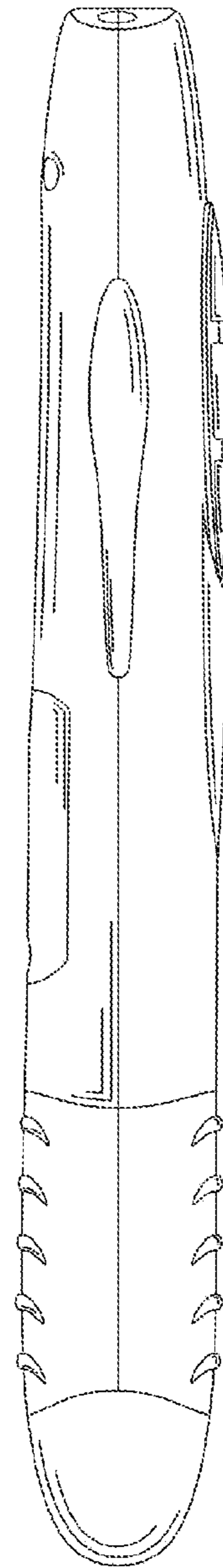

FIG. 6

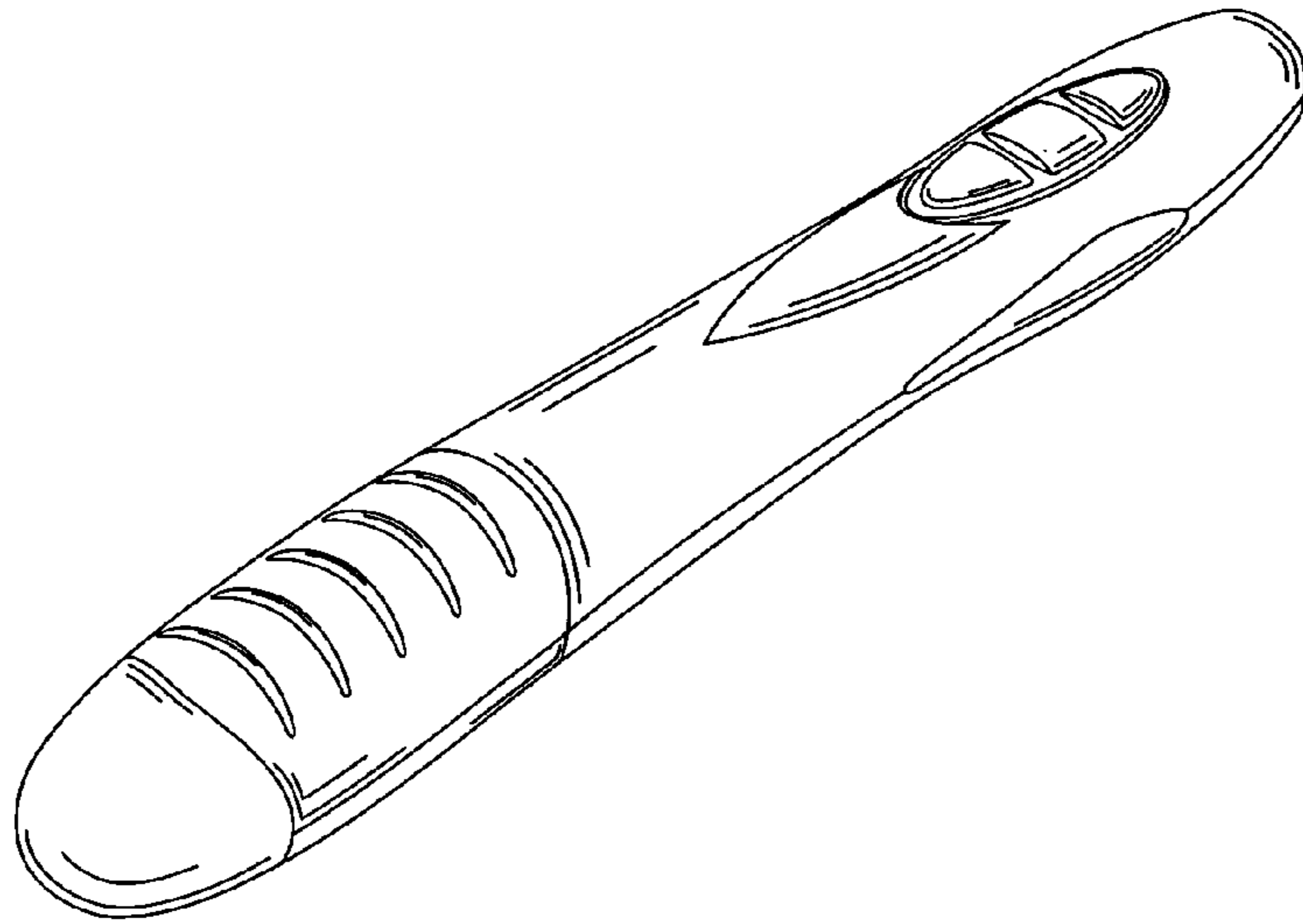

FIG. 7

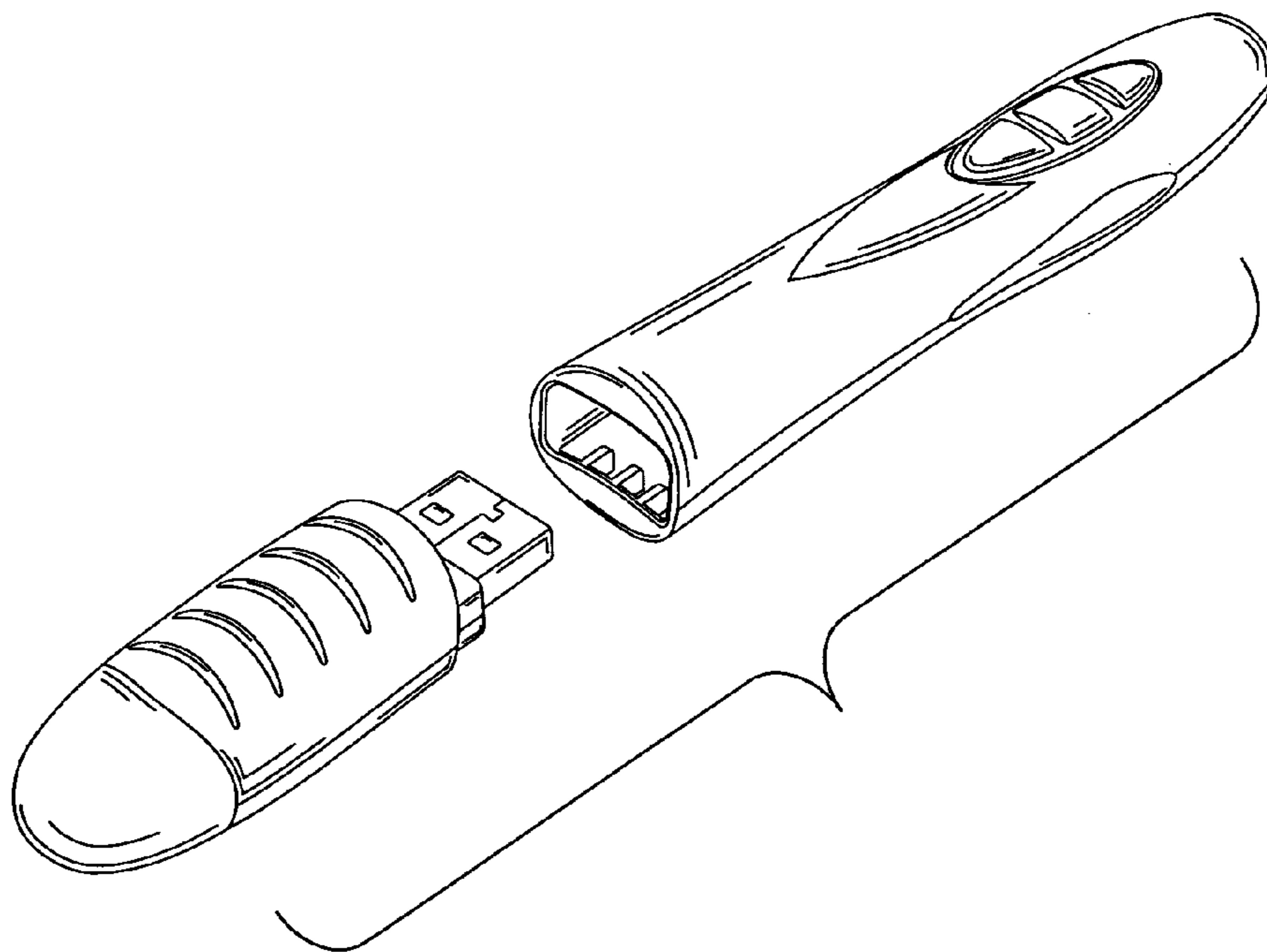

FIG. 8