



US00D568293S

(12) **United States Design Patent**  
**Sawhney et al.**

(10) **Patent No.:** **US D568,293 S**  
(45) **Date of Patent:** **\*\* May 6, 2008**

(54) **LOUDSPEAKER HOUSING**

(57) **CLAIM**

The ornamental design for a loudspeaker housing, as shown and described.

(75) Inventors: **Ravi Sawhney**, Calabasas, CA (US);  
**Lance Hussey**, Simi Valley, CA (US);  
**Kurt Botsai**, Thousand Oaks, CA (US);  
**Chris Glupker**, Studio City, CA (US)

**DESCRIPTION**

(73) Assignee: **Harman International Industries, Incorporated**, Northridge, CA (US)

FIG. 1 is a perspective view of a loudspeaker housing showing our new design;

(\*\*) Term: **14 Years**

FIG. 2 is a front elevational view thereof;

(21) Appl. No.: **29/275,527**

FIG. 3 is a rear elevational view thereof;

(22) Filed: **Dec. 28, 2006**

FIG. 4 is a top plan view thereof;

(51) **LOC (8) Cl.** ..... **14-01**

FIG. 5 is a bottom plan view thereof;

(52) **U.S. Cl.** ..... **D14/214**

FIG. 6 is a side elevational view, the opposite side elevational view being a mirror image thereof;

(58) **Field of Classification Search** ..... D14/204,  
D14/209–216; 181/143–144, 147–148, 150,  
181/157, 198–199, 151, 153; 381/300–302,  
381/306, 333, 345, 361–364, 386–388, 332,  
381/336

FIG. 7 is a perspective view of a second embodiment of FIG. 1;

See application file for complete search history.

FIG. 8 is a front elevational view thereof;

(56) **References Cited**

**U.S. PATENT DOCUMENTS**

4,805,730	A *	2/1989	O'Neill et al.	.....	181/148
D405,450	S *	2/1999	Niitsu	.....	D14/214
D439,237	S *	3/2001	Felix et al.	.....	D14/214
D501,197	S *	1/2005	Tanoni	.....	D14/214
D521,981	S *	5/2006	Sogabe	.....	D14/214

FIG. 9 is a rear elevational view thereof;

FIG. 10 is a side elevational view, the opposite side elevational view being a mirror image thereof;

FIG. 11 is a top plan view thereof;

FIG. 12 is a bottom plan view thereof;

FIG. 13 is a perspective view of a third embodiment of FIG. 1;

FIG. 14 is a front elevational view thereof;

FIG. 15 is a rear elevational view thereof;

FIG. 16 is a side elevational view, the opposite side elevational view being a mirror image thereof;

FIG. 17 is a top plan view thereof; and,

FIG. 18 is a bottom plan view thereof.

The broken line showings of the rectangles on the front faces, the handle grips, the rectangles on the rear faces, the parallel lines on the top surface and the circular feet on the bottom surface are for illustrative purposes only and form no part of the claimed design.

\* cited by examiner

*Primary Examiner*—Nanda Bondade

(74) *Attorney, Agent, or Firm*—Plumsea Law Group, LLC

**1 Claim, 6 Drawing Sheets**

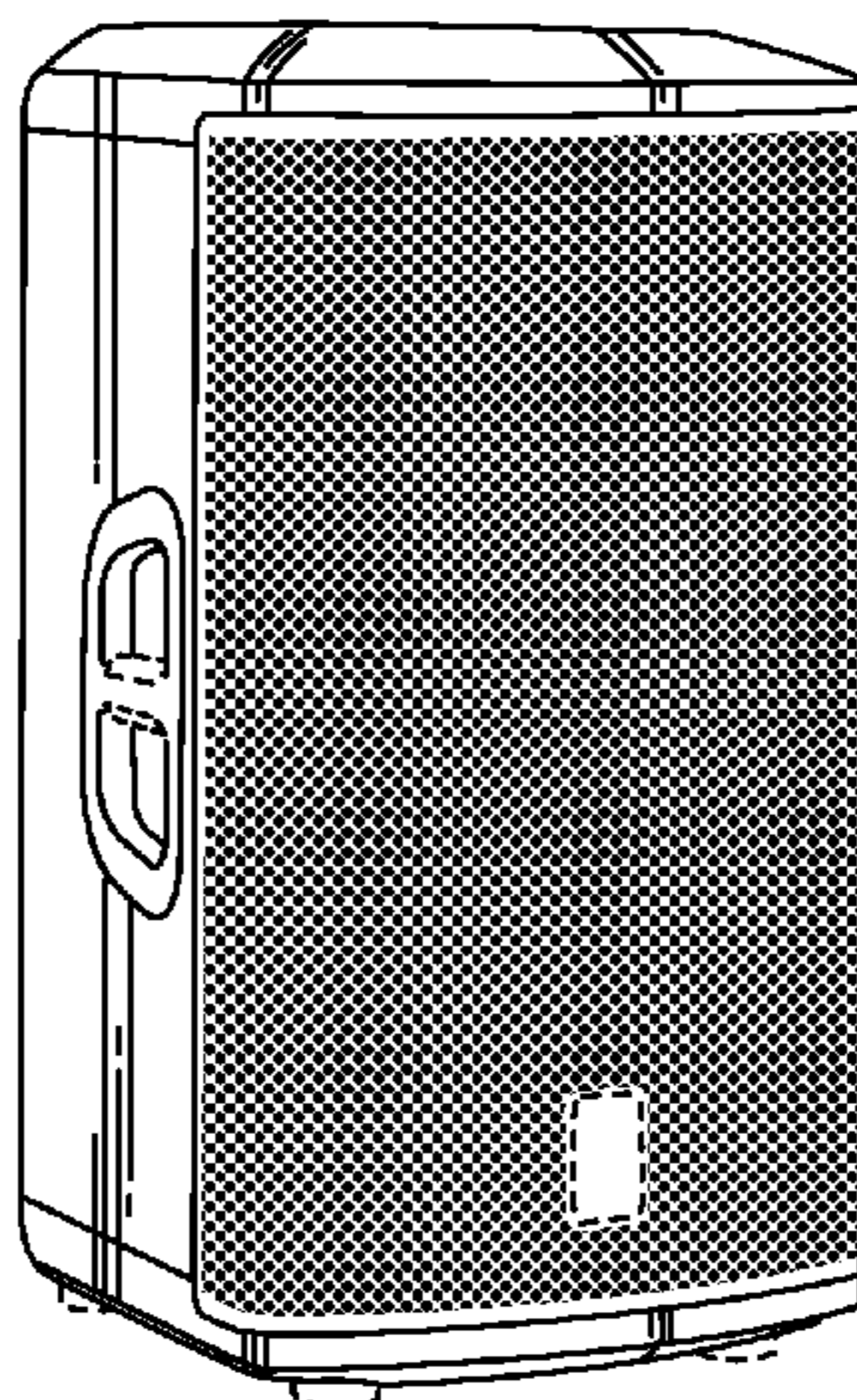

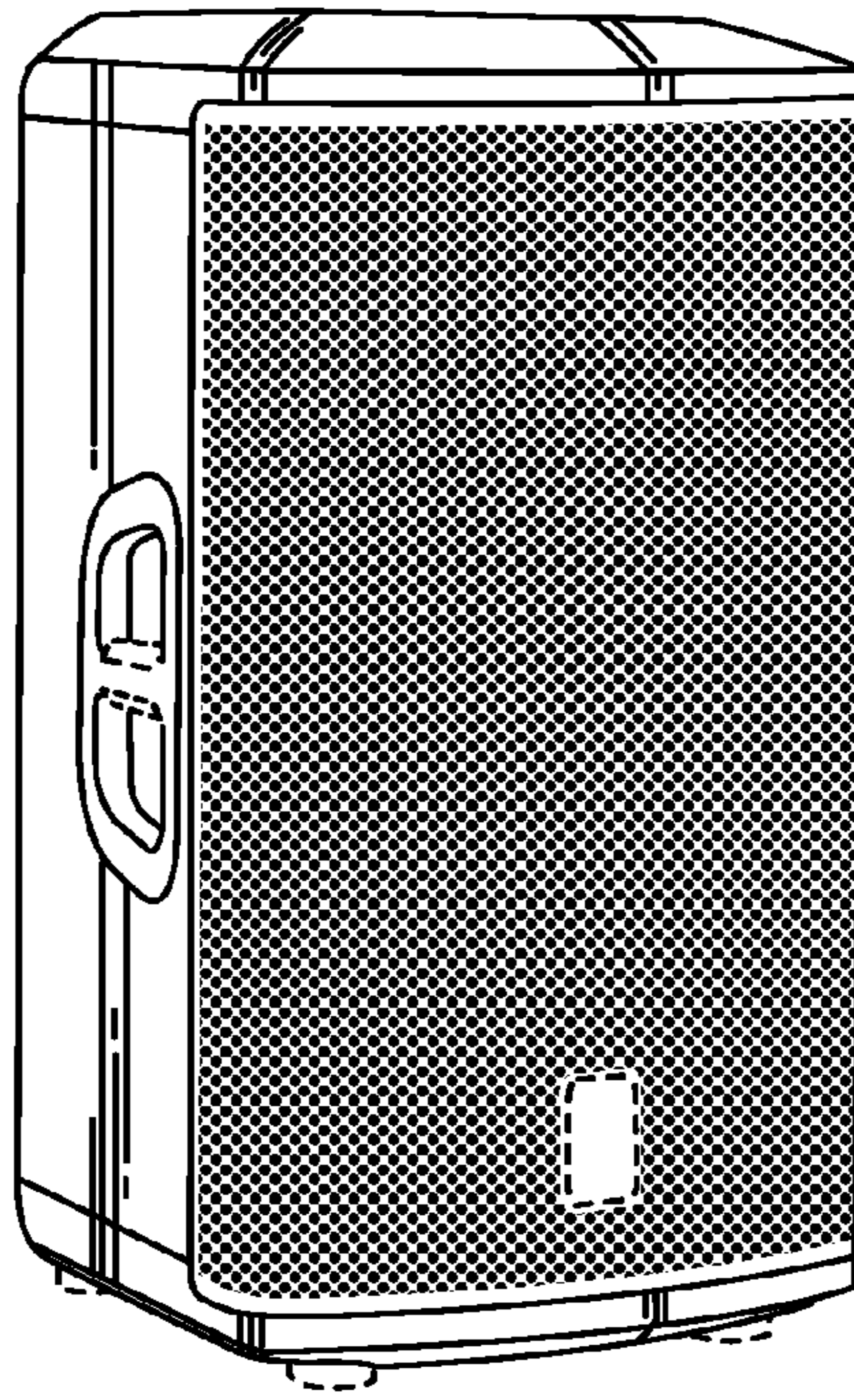

FIG. 1

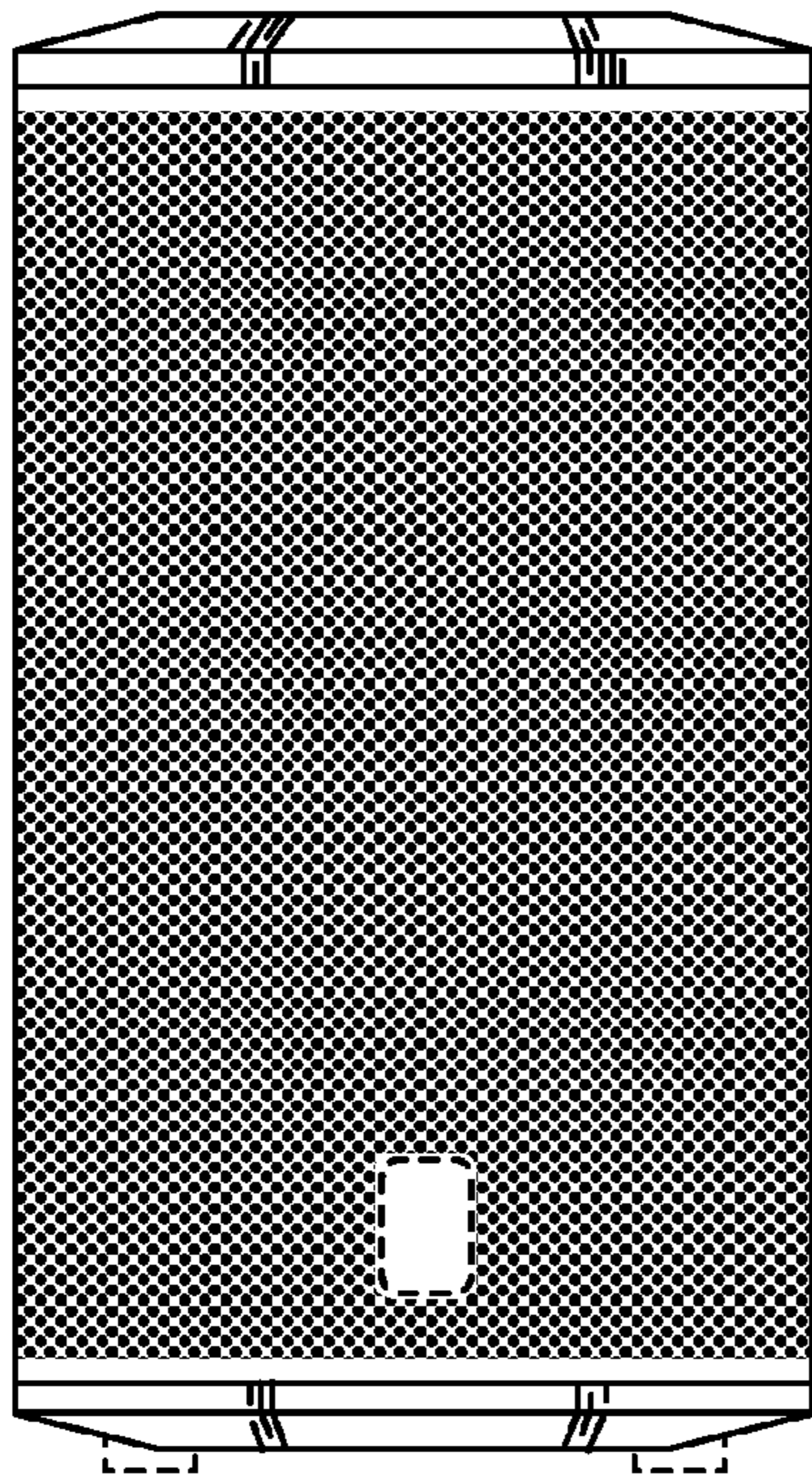

FIG. 2

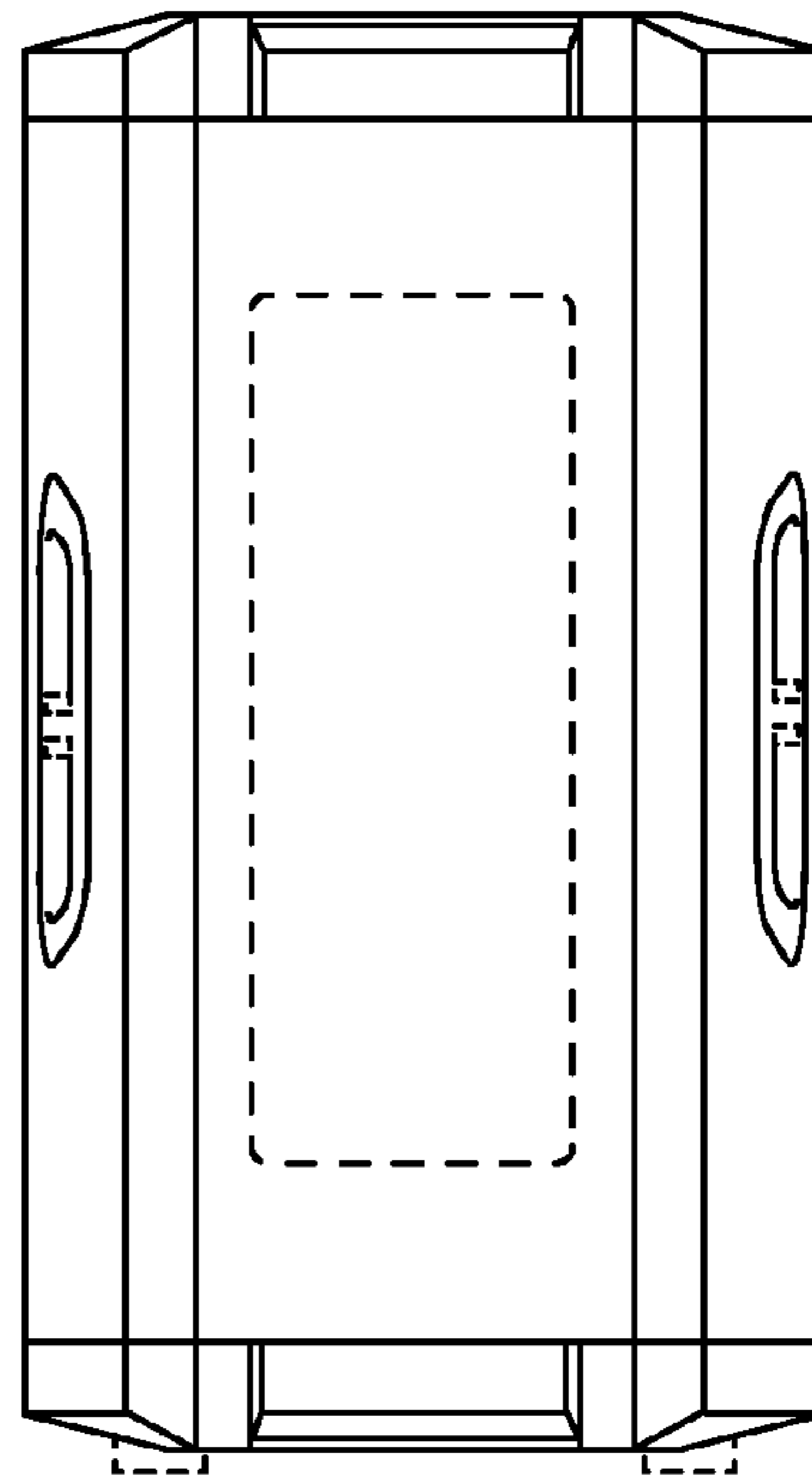

FIG. 3

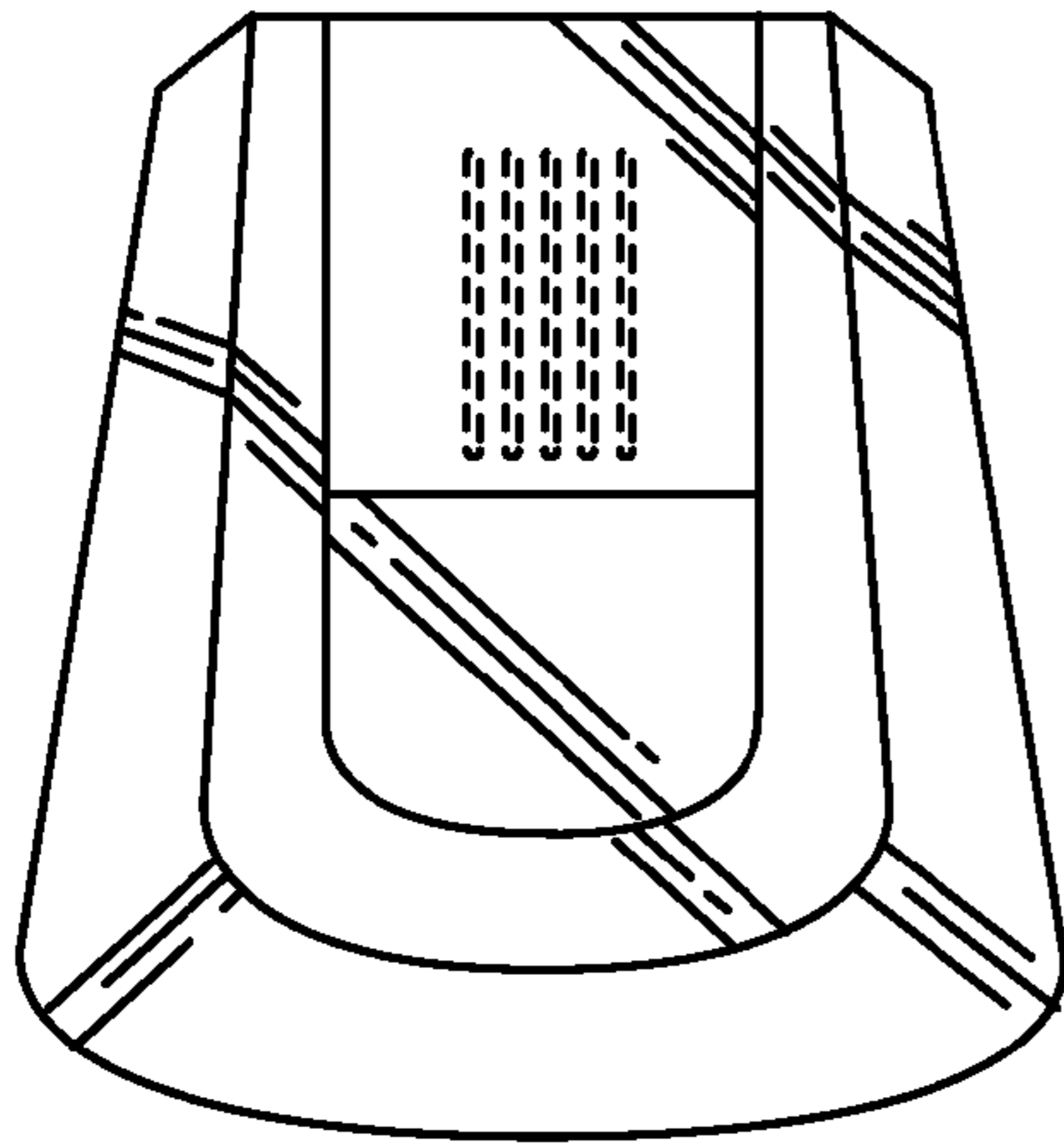

FIG. 4

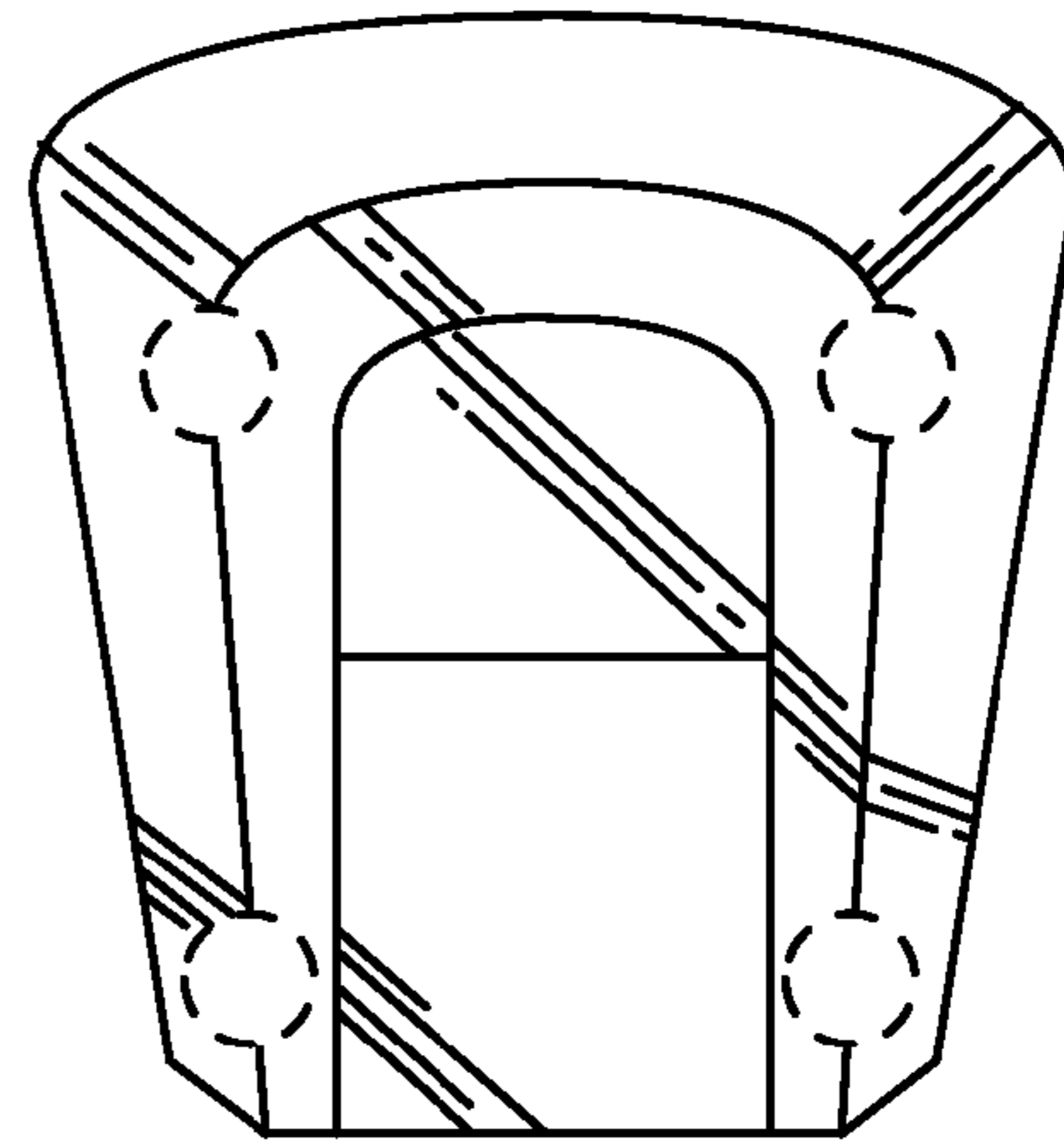

FIG. 5

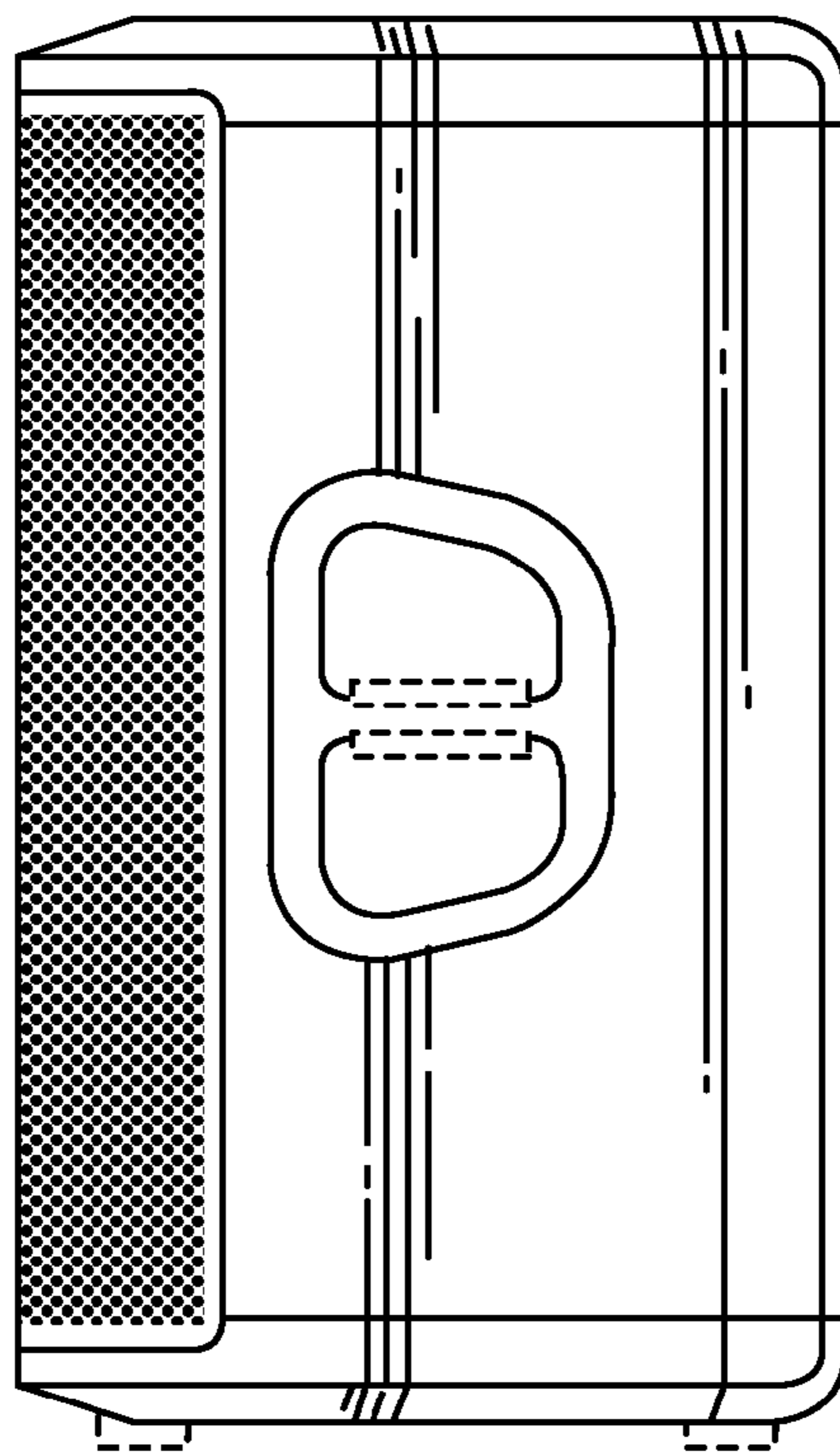

FIG. 6

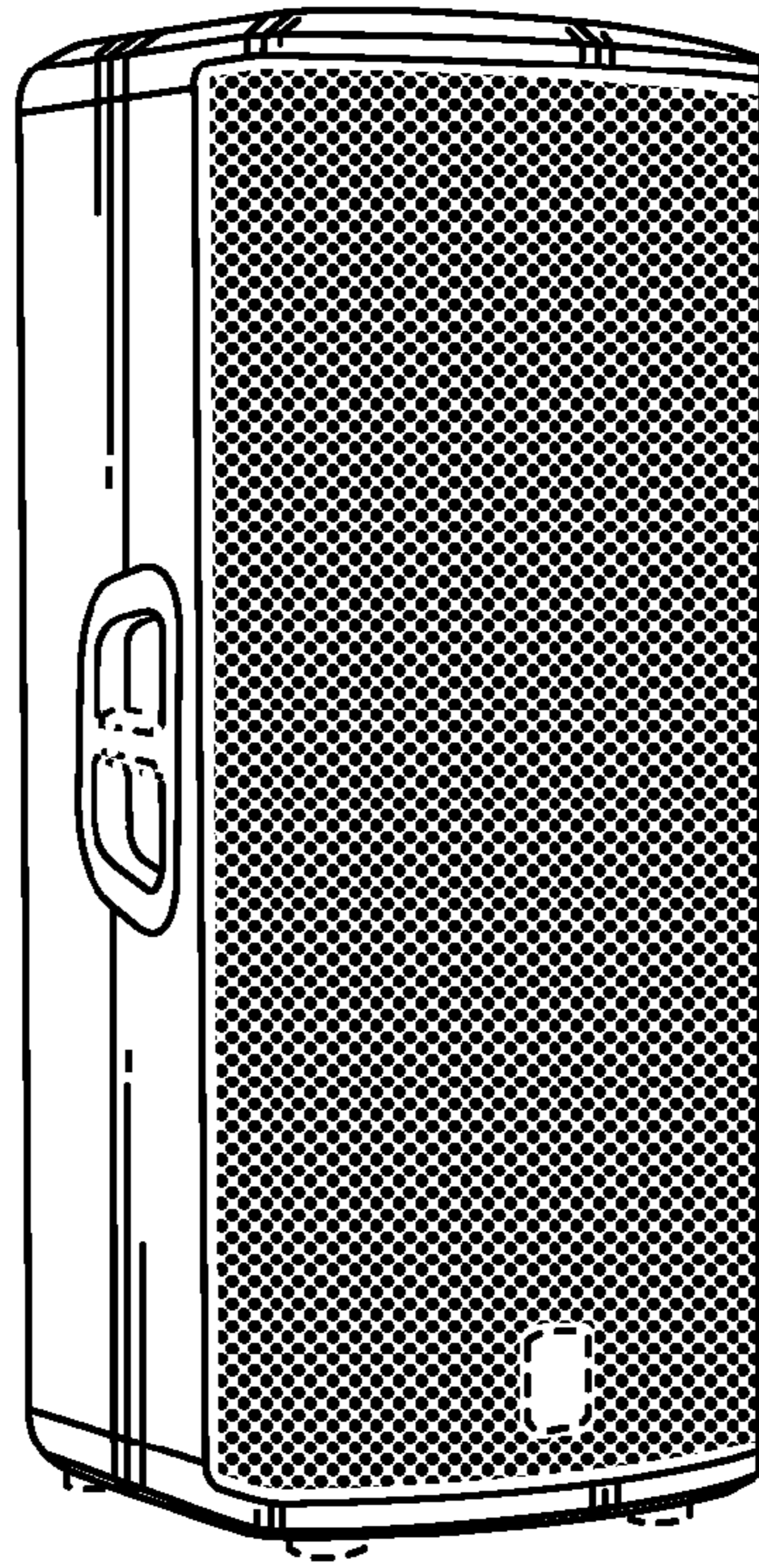

FIG. 7

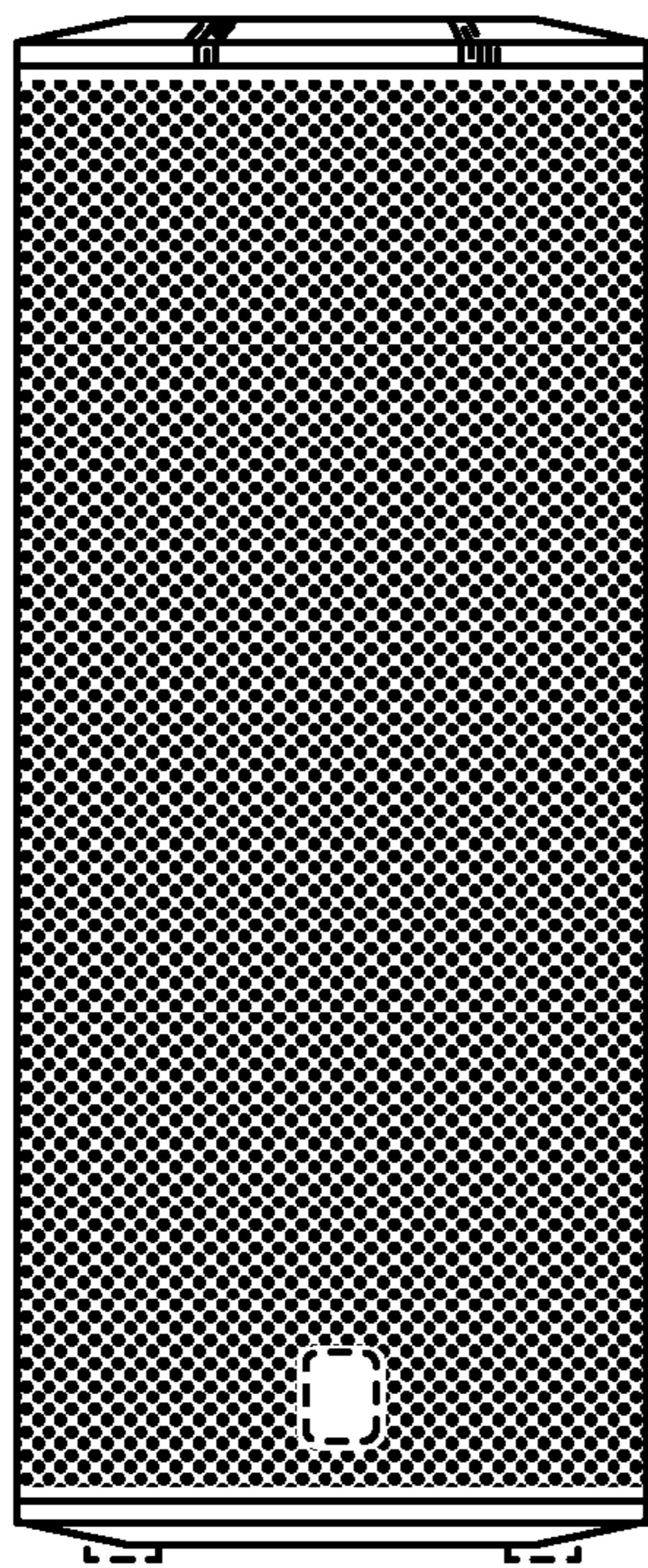

FIG. 8

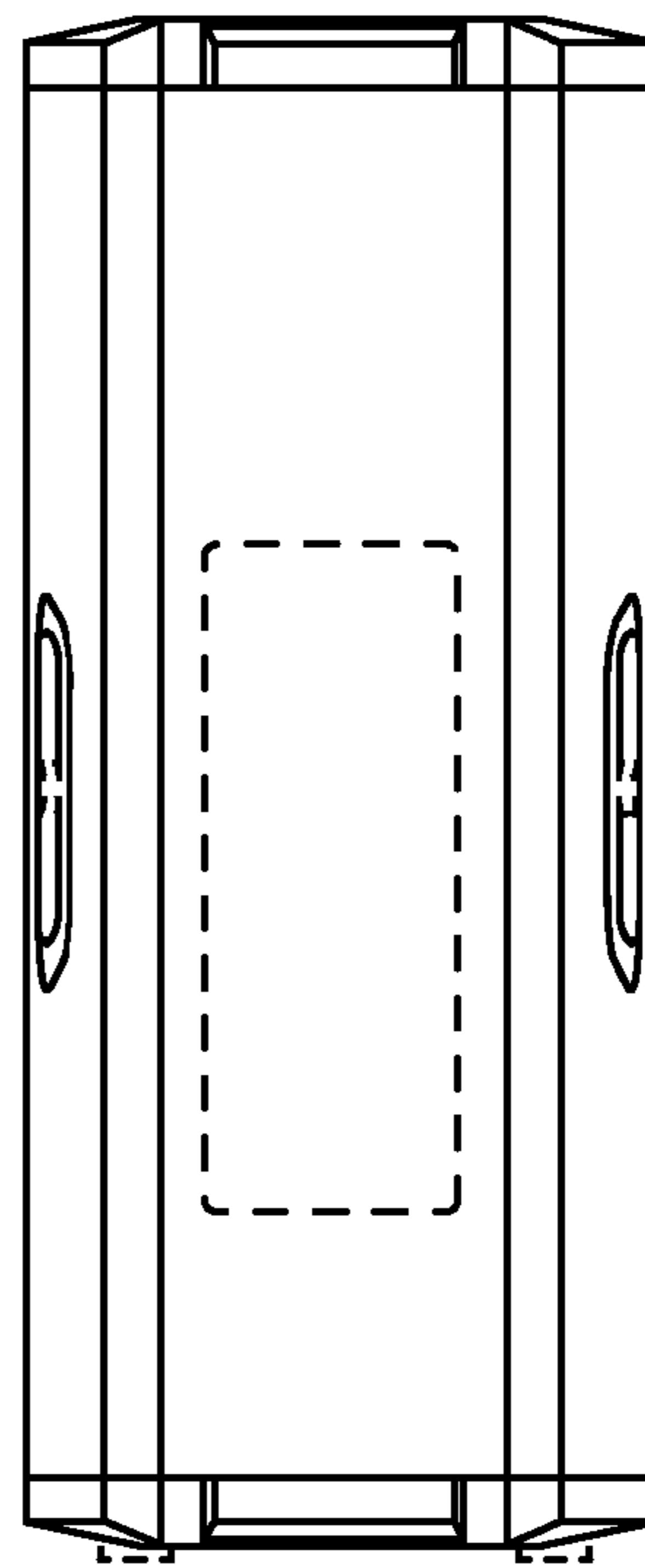

FIG. 9

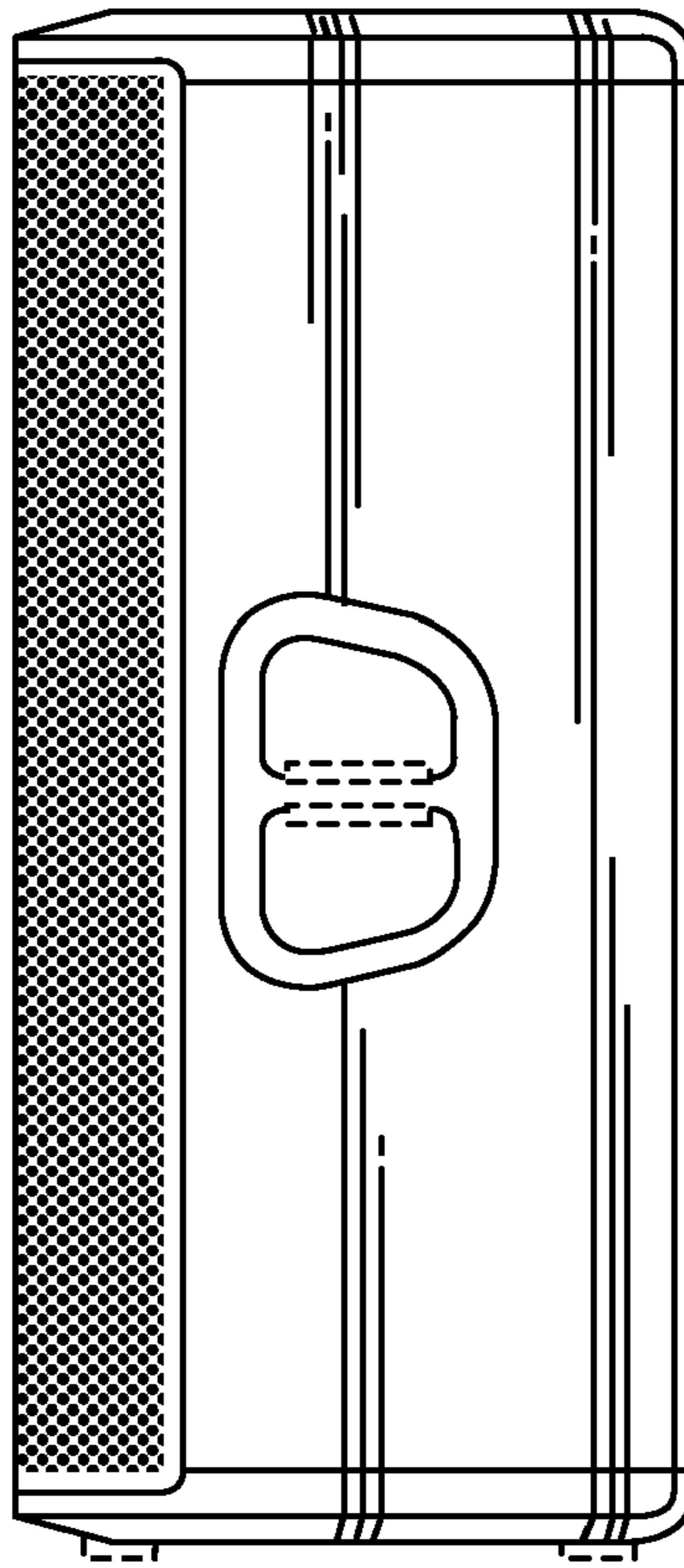

FIG. 10

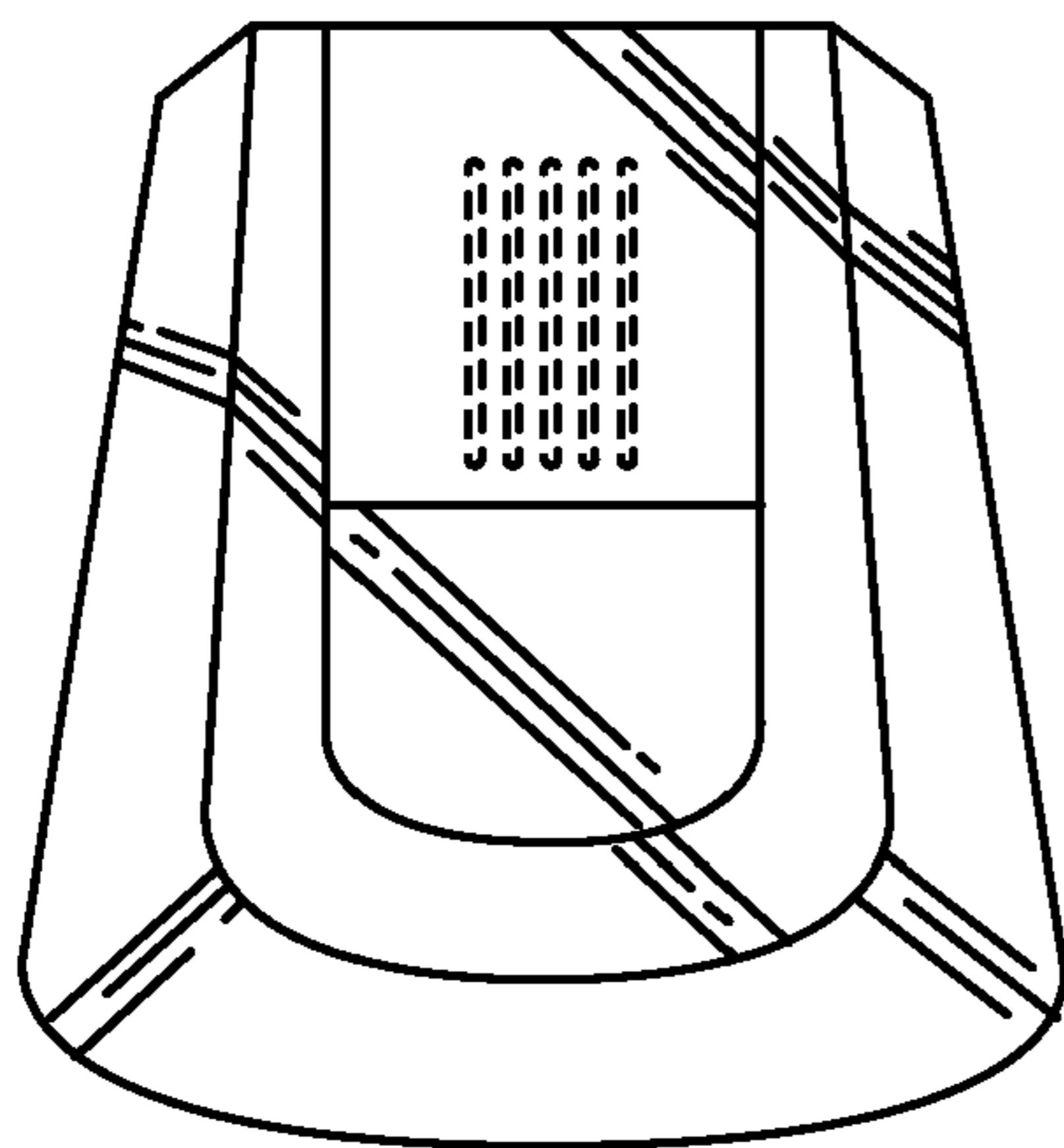

FIG. 11

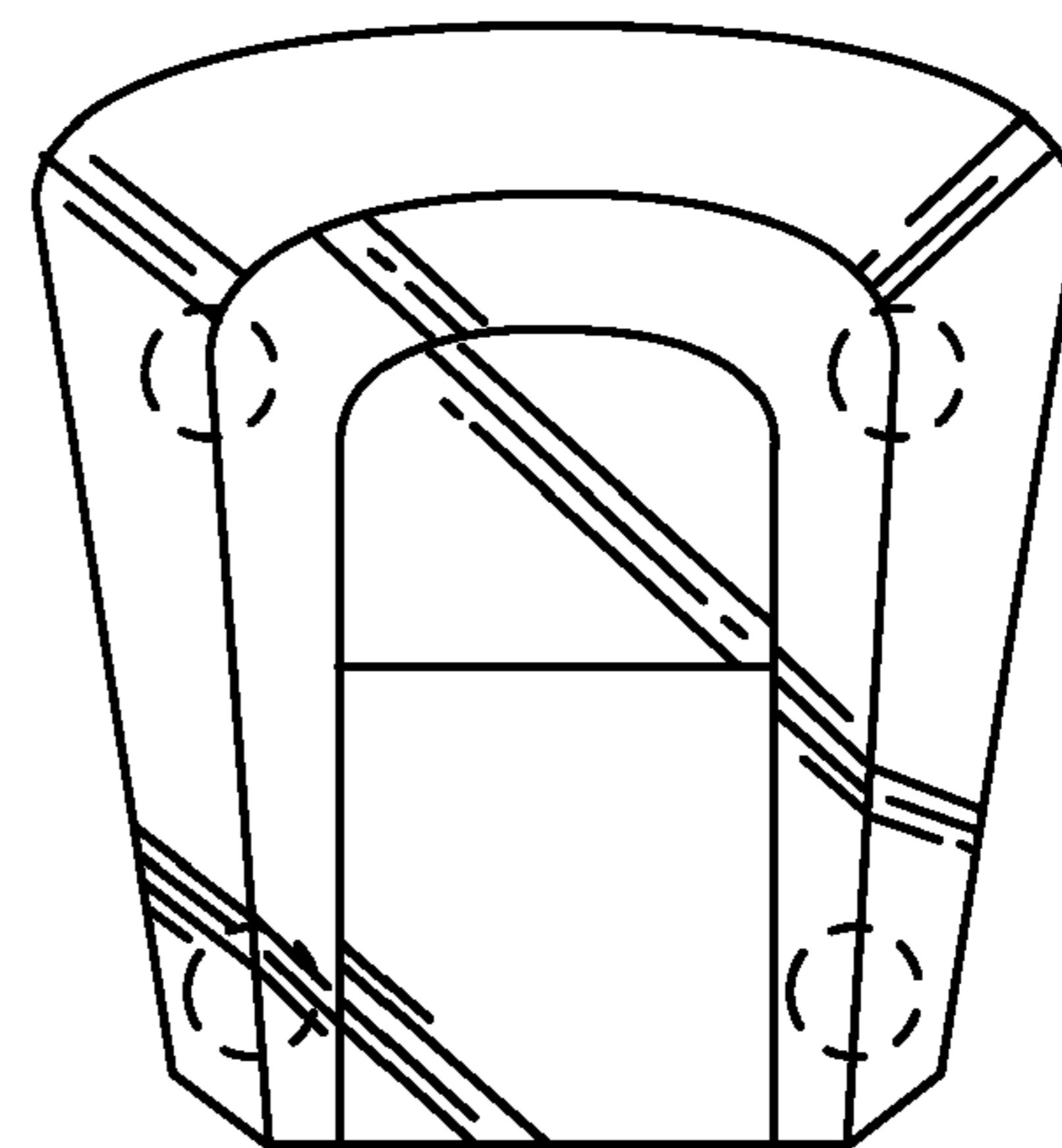

FIG. 12

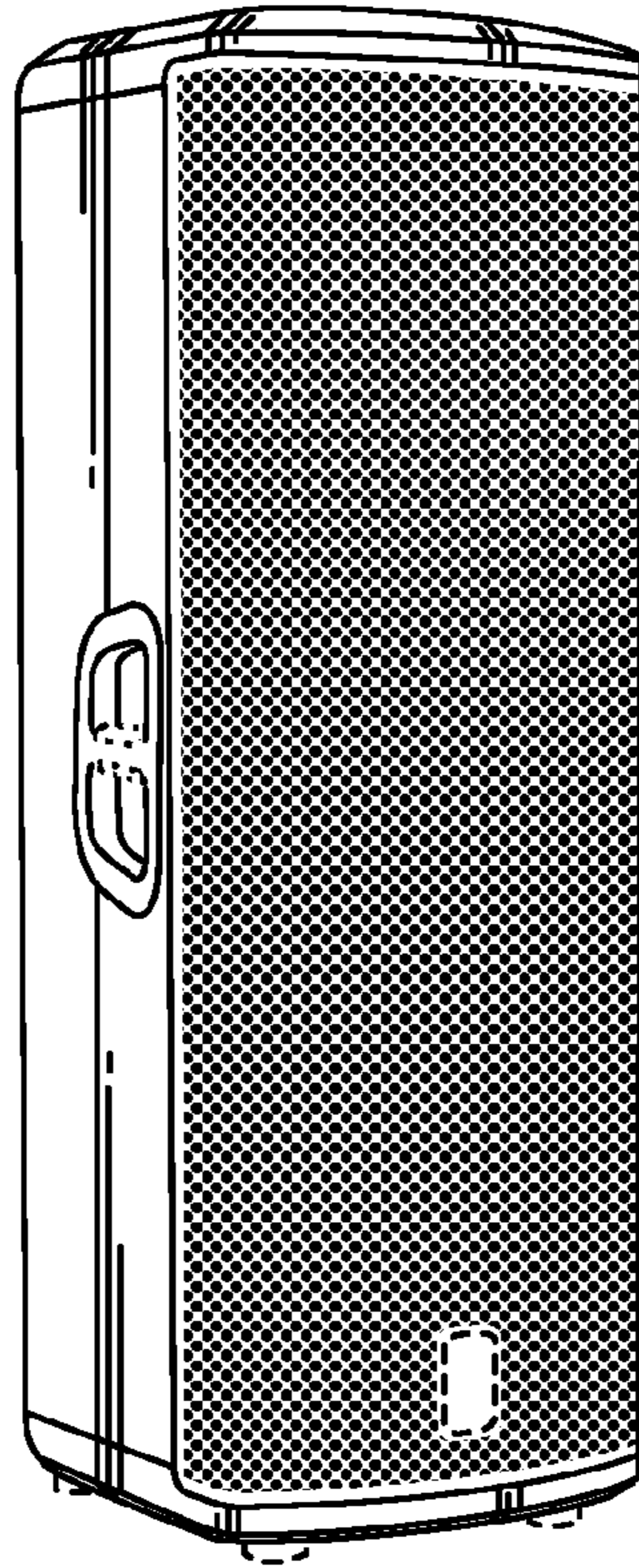

FIG. 13

FIG. 14

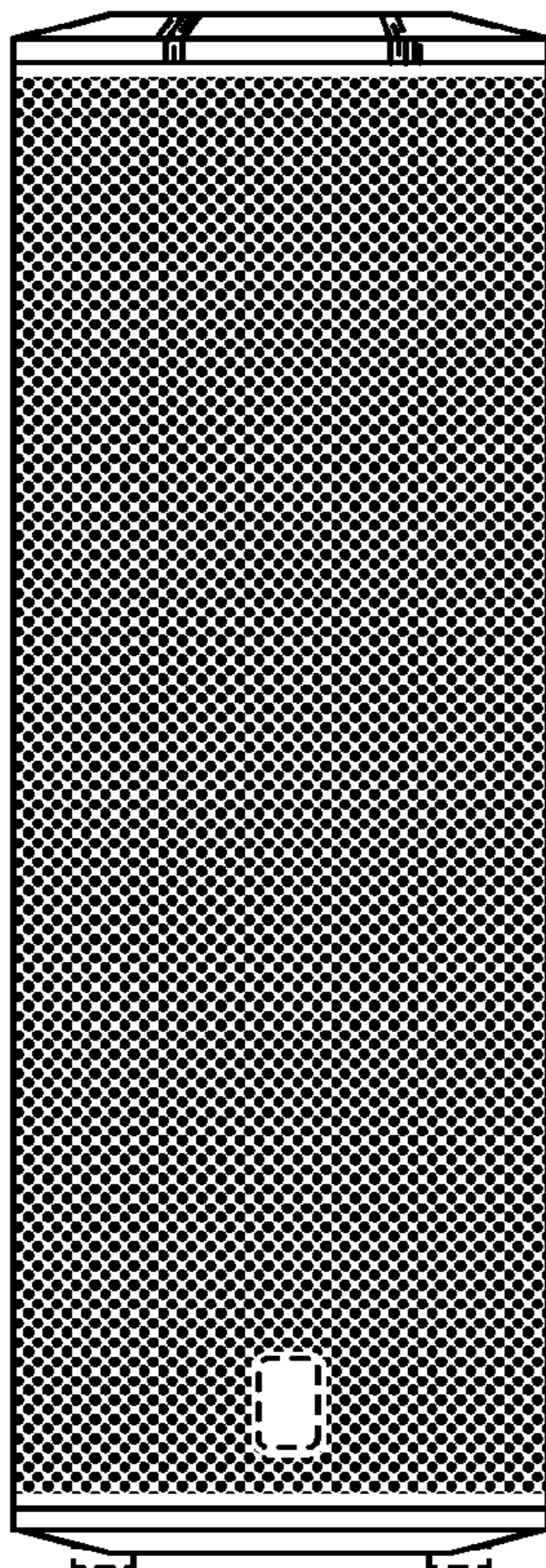
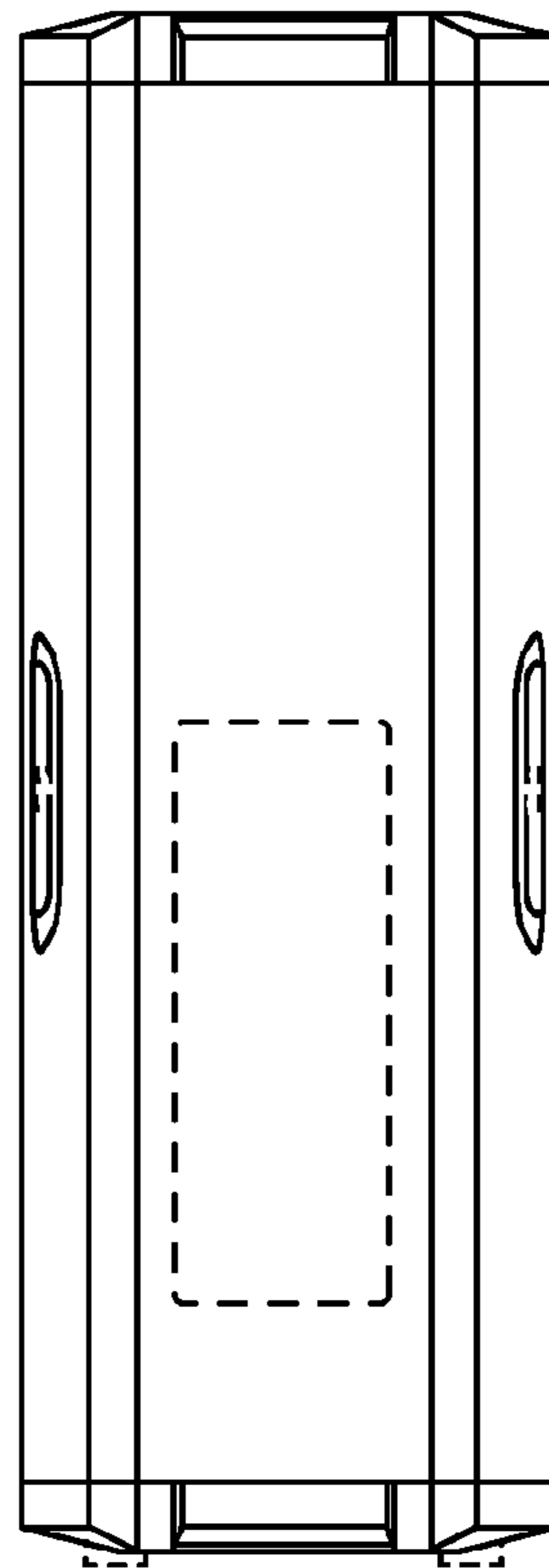

FIG. 15



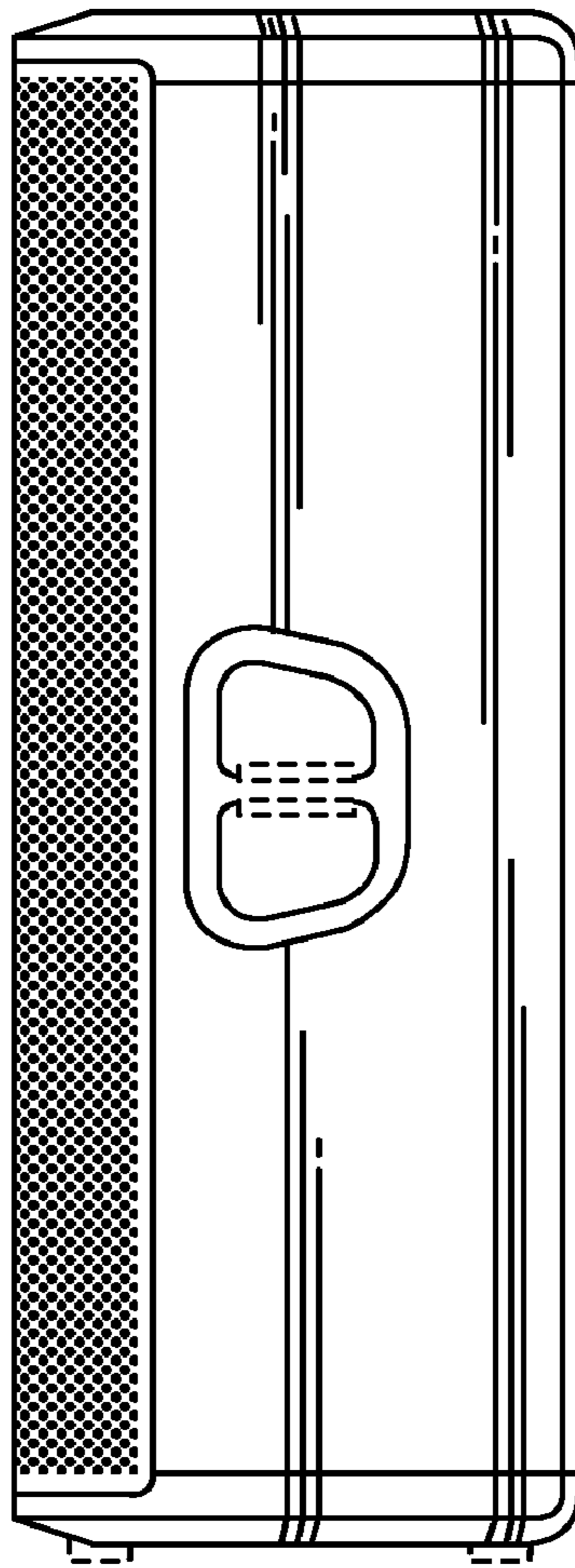

FIG. 16

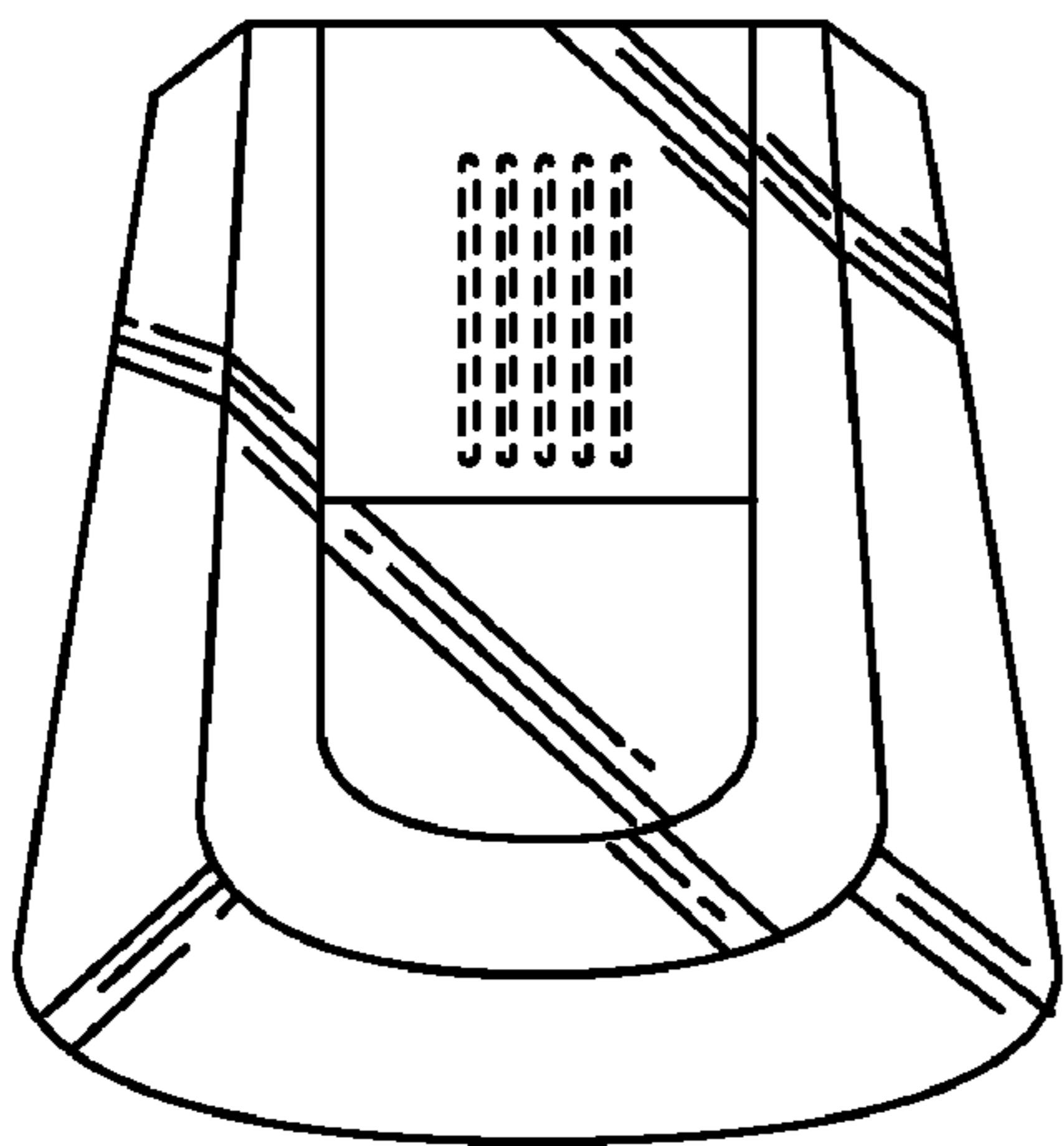

FIG. 17

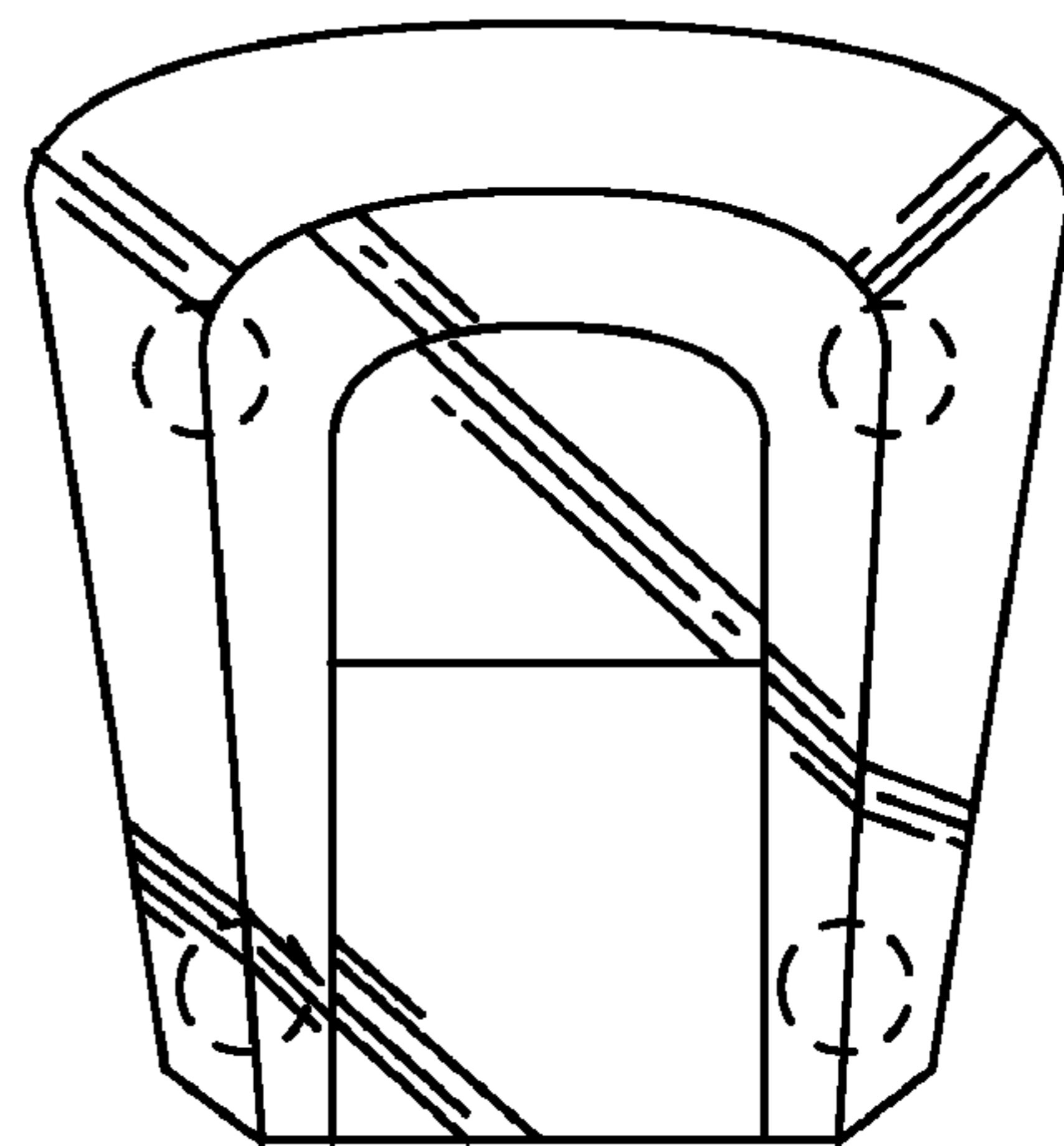

FIG. 18