

US00D568284S

(12) **United States Design Patent**
Lee et al.

(10) **Patent No.:** **US D568,284 S**
(45) **Date of Patent:** **** May 6, 2008**

(54) **MOBILE PHONE**

(75) Inventors: **Ki-Eon Lee**, Seoul (KR); **Yoon-Young Cho**, Seoul (KR); **Chang-Soo Lee**, Incheon (KR)

(73) Assignee: **Samsung Electronics Co., Ltd.**, Suwon-Si (KR)

(**) Term: **14 Years**

(21) Appl. No.: **29/274,173**

(22) Filed: **Apr. 2, 2007**

(30) **Foreign Application Priority Data**

Jan. 15, 2007 (KR) 30-2007-0001926

(51) **LOC (8) Cl.** **14-03**

(52) **U.S. Cl.** **D14/138**

(58) **Field of Classification Search** D14/137, D14/138, 147, 218, 341-347; D5/1, 6, 16, D5/24, 32, 34, 37-40, 45, 47, 54, 56, 58, D5/66; 455/90.3, 556.1, 556.2, 575.1, 575.3, 455/575.4; 379/433.01-433.13; 361/814; 348/14.02

See application file for complete search history.

(56) **References Cited**

U.S. PATENT DOCUMENTS

D363,069 S *	10/1995	Bro	D14/191
D429,707 S *	8/2000	Park	D14/138
D447,128 S *	8/2001	Lee et al.	D14/138
D459,329 S *	6/2002	Suzuki et al.	D14/138
D476,302 S *	6/2003	Hwang et al.	D14/138
D486,811 S *	2/2004	Lheem	D14/138
D488,791 S *	4/2004	Honda et al.	D14/138
D501,457 S *	2/2005	Lee et al.	D14/138
D509,815 S *	9/2005	Jang	D14/138
D518,465 S *	4/2006	Van Den Nieuwenhuizen et al.	D14/138
D519,478 S *	4/2006	Lee et al.	D14/138
D527,363 S *	8/2006	Kim et al.	D14/138
D535,960 S *	1/2007	Kim et al.	D14/138

D539,773 S *	4/2007	Kim et al.	D14/138
D542,771 S *	5/2007	Cho et al.	D14/138
D543,174 S *	5/2007	Kim	D14/138
D546,308 S *	7/2007	Lee	D14/138
D552,059 S *	10/2007	Cho et al.	D14/138
D553,126 S *	10/2007	Katayama	D14/248
D555,124 S *	11/2007	Lee	D14/138
D556,722 S *	12/2007	Kim et al.	D14/138
D557,669 S *	12/2007	Kim et al.	D14/138
D558,712 S *	1/2008	Kim et al.	D14/138
2003/0083022 A1 *	5/2003	Oomori et al.	455/90
2003/0203747 A1 *	10/2003	Nagamine	455/575.3
2006/0046792 A1 *	3/2006	Hassemer et al.	455/575.1

OTHER PUBLICATIONS

Samsung E570, announced Oct. 2006, [online], [retrieved on Nov. 3, 2007]. Retrieved from Internet ,<URL: http://www.gsmarena.com>.*

(Continued)

Primary Examiner—Jeffrey Asch
Assistant Examiner—Bridget L Eland
(74) *Attorney, Agent, or Firm*—Staas & Halsey LLP

(57) **CLAIM**

The ornamental design for a mobile phone, as shown and described.

DESCRIPTION

FIG. 1 is a perspective view of a mobile phone;
FIG. 2 is a front view of the mobile phone of FIG. 1;
FIG. 3 is a rear view of the mobile phone of FIG. 1;
FIG. 4 is a left-side view of the mobile phone of FIG. 1;
FIG. 5 is a right-side view of the mobile phone of FIG. 1;
FIG. 6 is a top plan view of the mobile phone of FIG. 1;
FIG. 7 is a bottom plan view of the mobile phone of FIG. 1;
and,
FIG. 8 is an open perspective view of the mobile phone of FIG. 1.

1 Claim, 3 Drawing Sheets

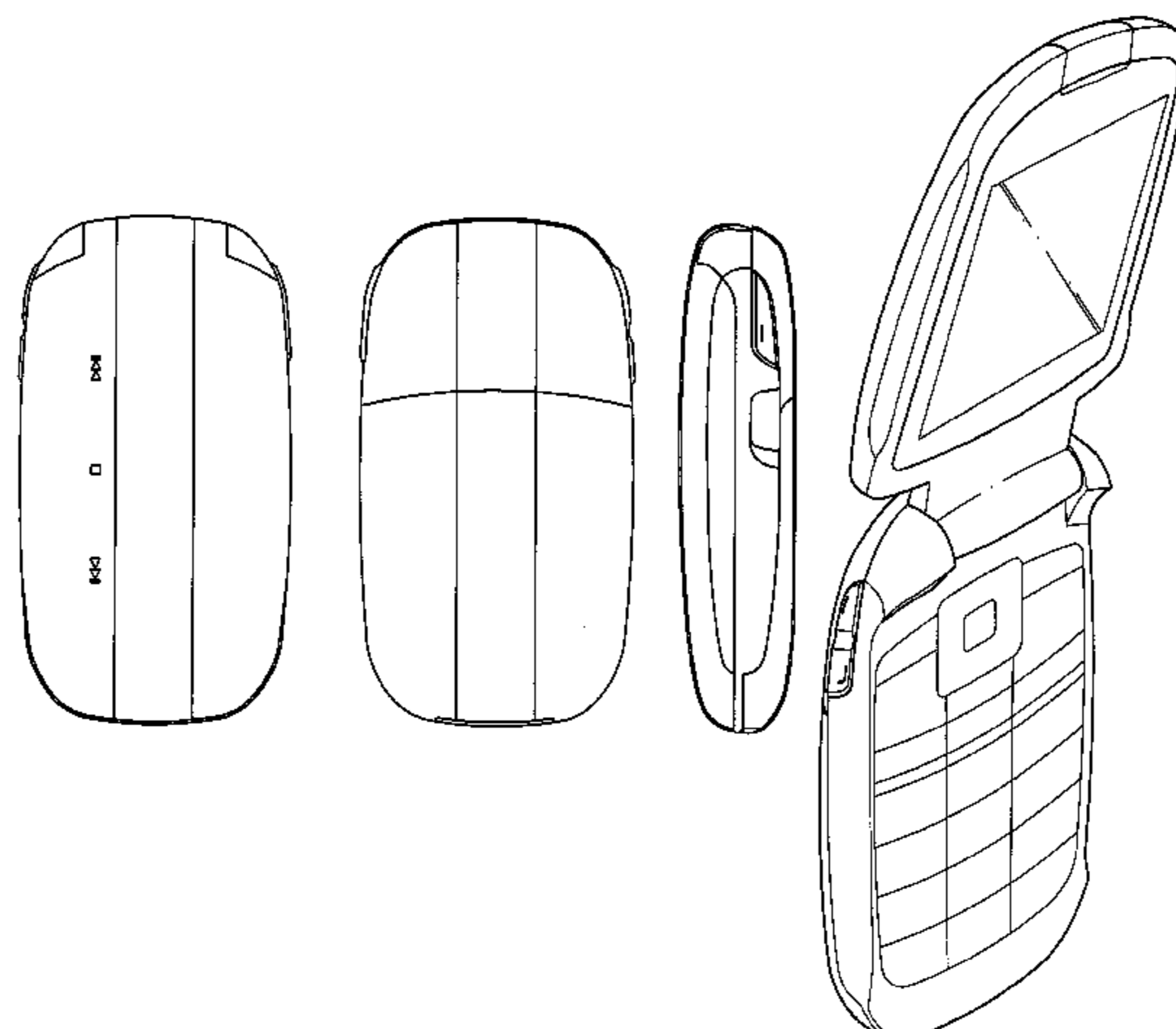

OTHER PUBLICATIONS

Haier A7, announced 2006, [online], [retrieved on Jul. 6, 2007]. Retrieved from Internet ,<URL: <http://www.gsmarena.com>>.*

Samsung E530, announced 1st quarter 2005, [online], [retrieved on Jul. 6, 2007]. Retrieved from Internet ,<URL: <http://www.gsmarena.com>>.*

Motorola PEBL U6, announced 1st quarter 2005, [online], [retrieved on Jul. 6, 2007]. Retrieved from Internet ,<URL: <http://www.gsmarena.com>>.*

Samsung C520, announced Apr. 2007, [online], [retrieved on Sep. 4, 2007]. Retrieved from Internet ,<URL: <http://www.gsmarena.com>>.*

Samsung E490, announced Nov. 2006, [online], [retrieved on Dec. 4, 2007]. Retrieved from Internet ,<URL: <http://www.gsmarena.com>>.*

LG KP200, announced Jun. 2007, [online], [retrieved on Dec. 4, 2007]. Retrieved from Internet ,<URL: <http://www.gsmarena.com>>.*

Siemens CL75, announced 1st quarter 2005, [online], [retrieved on Dec. 4, 2007]. Retrieved from Internet ,<URL: <http://www.gsmarena.com>>.*

* cited by examiner

FIG. 1

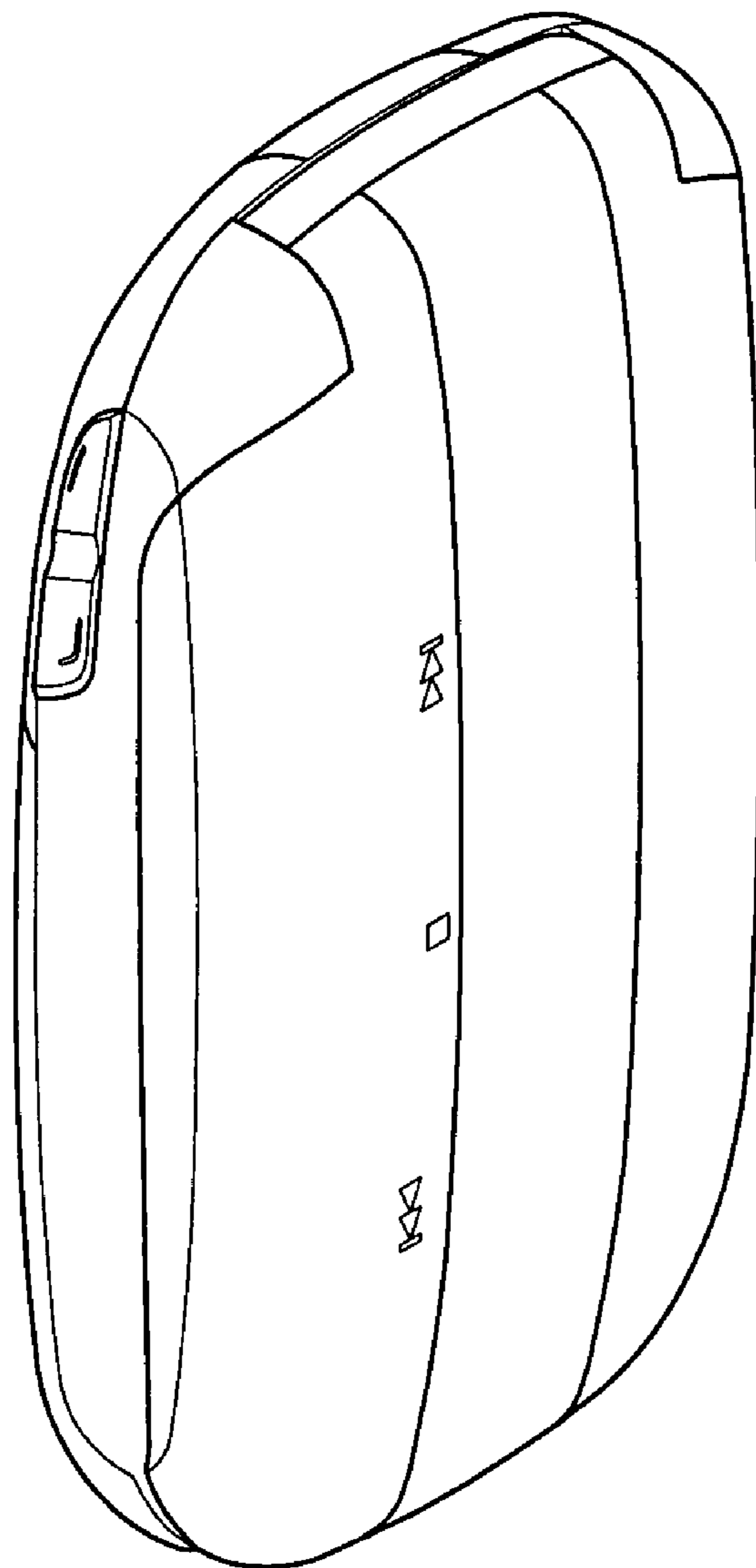

FIG.2

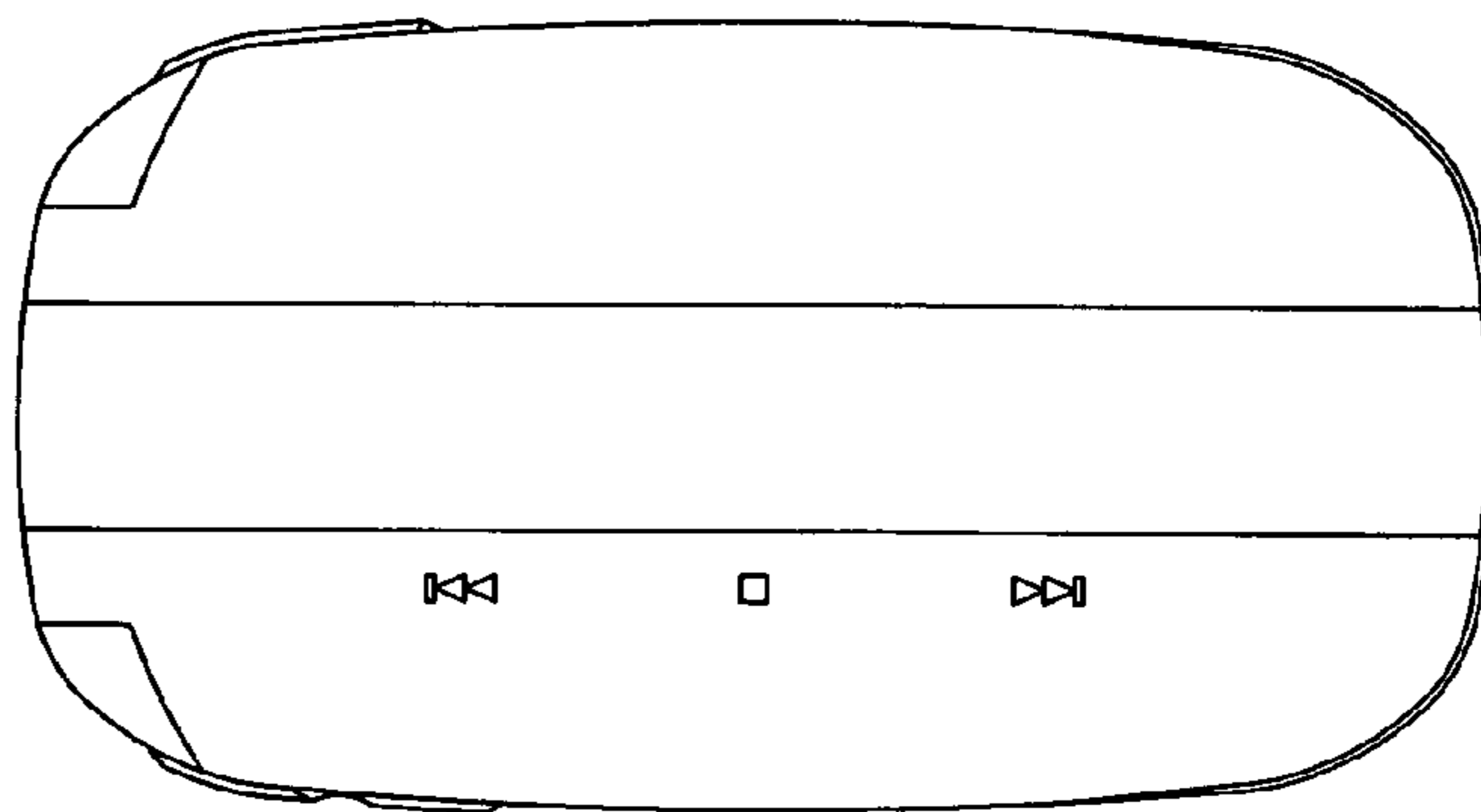

FIG.3

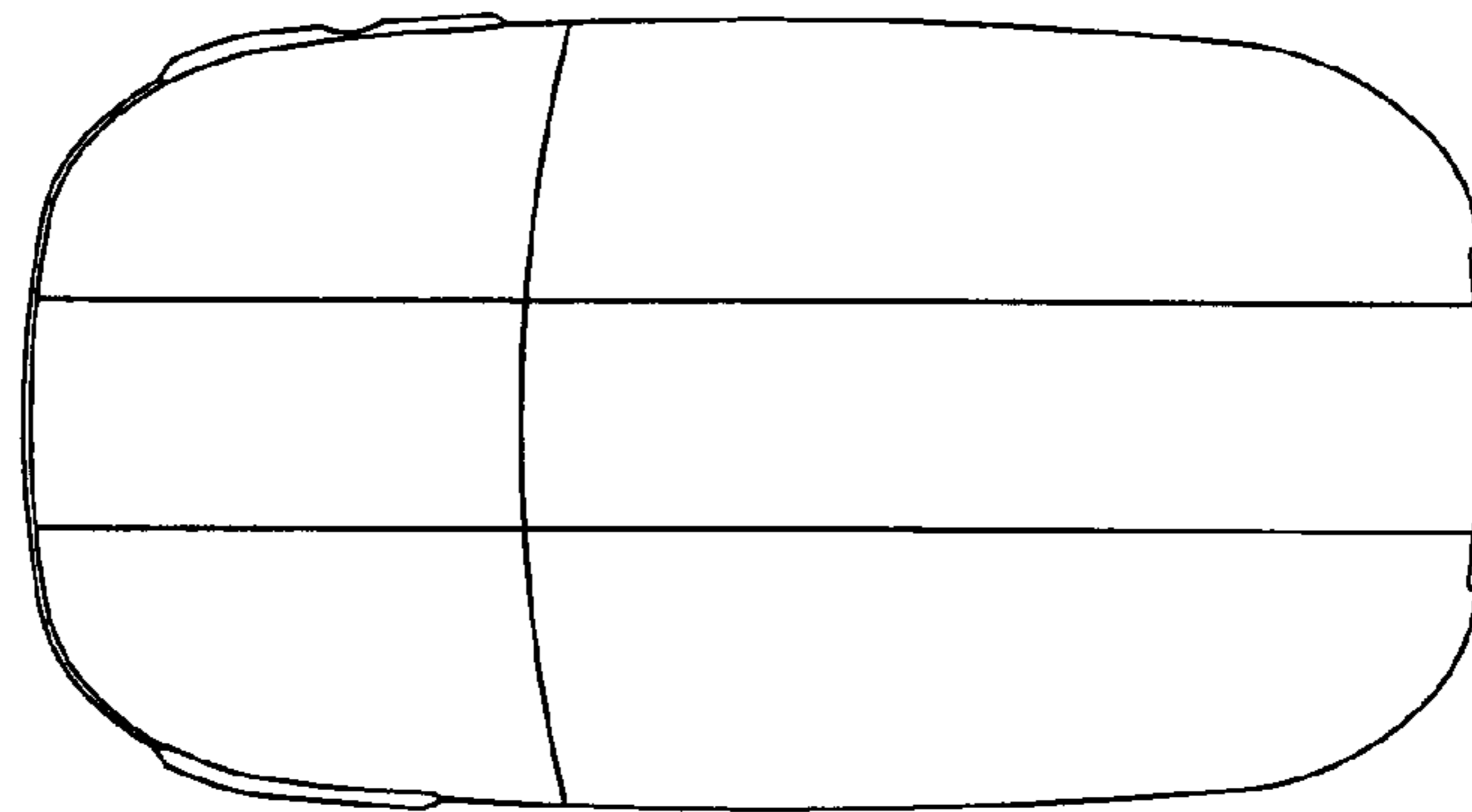

FIG.4

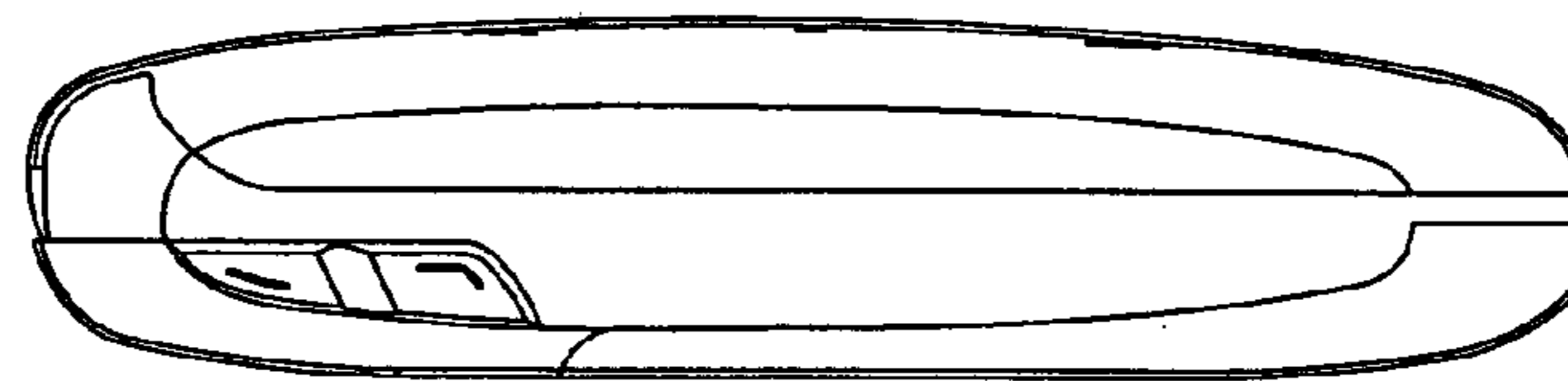

FIG.5

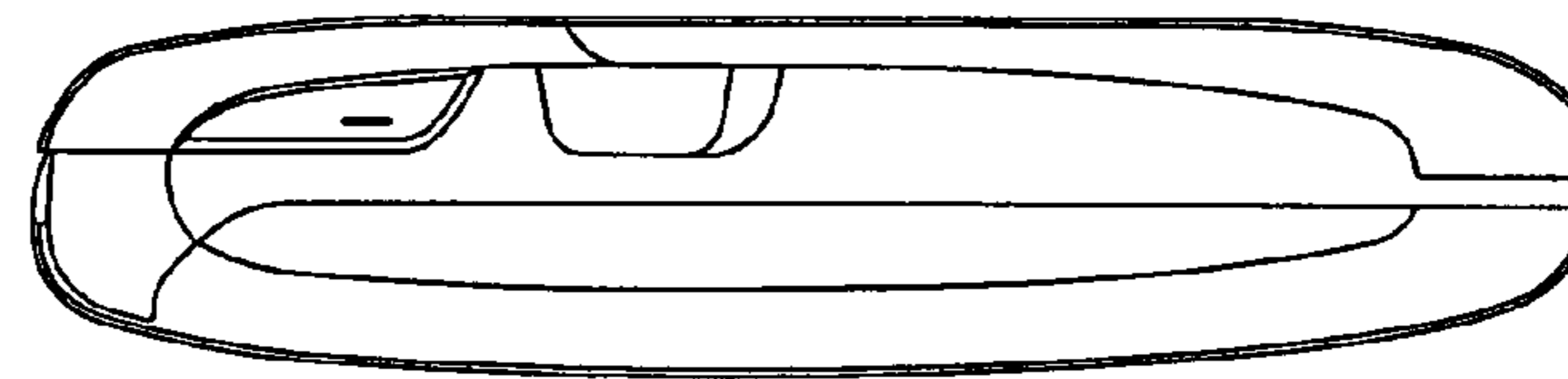

FIG.6

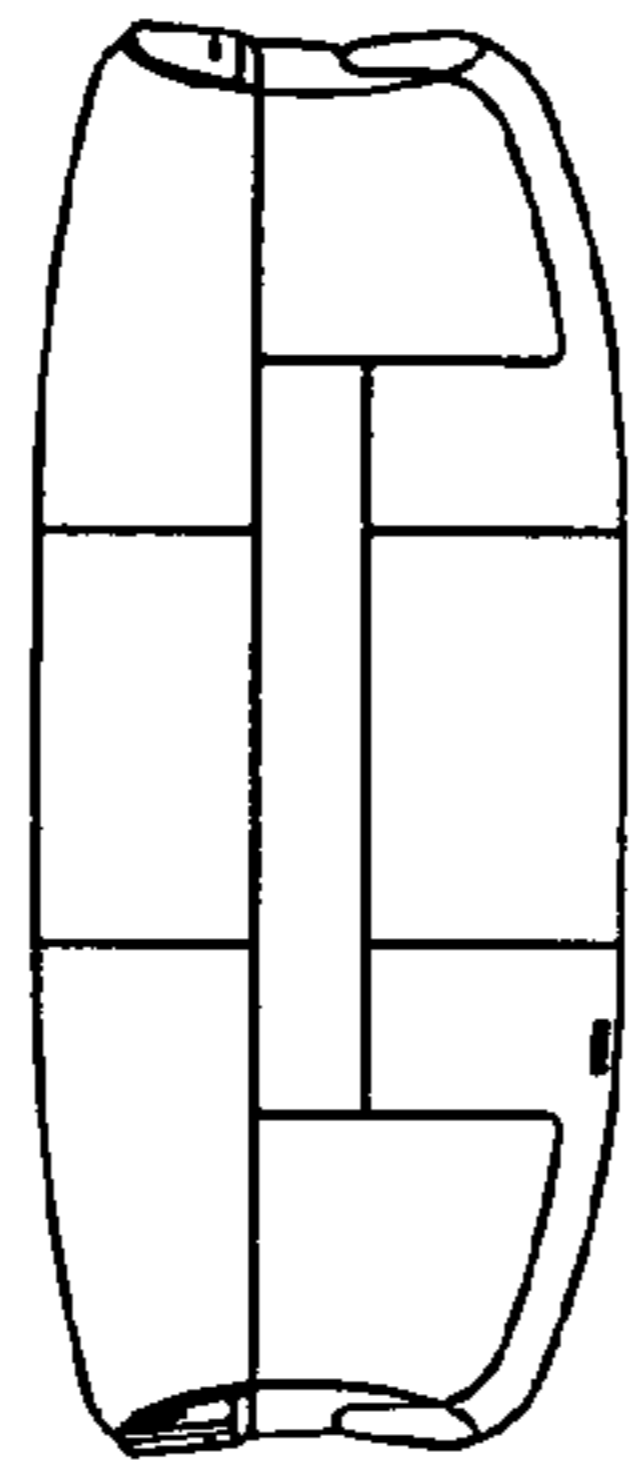

FIG.7

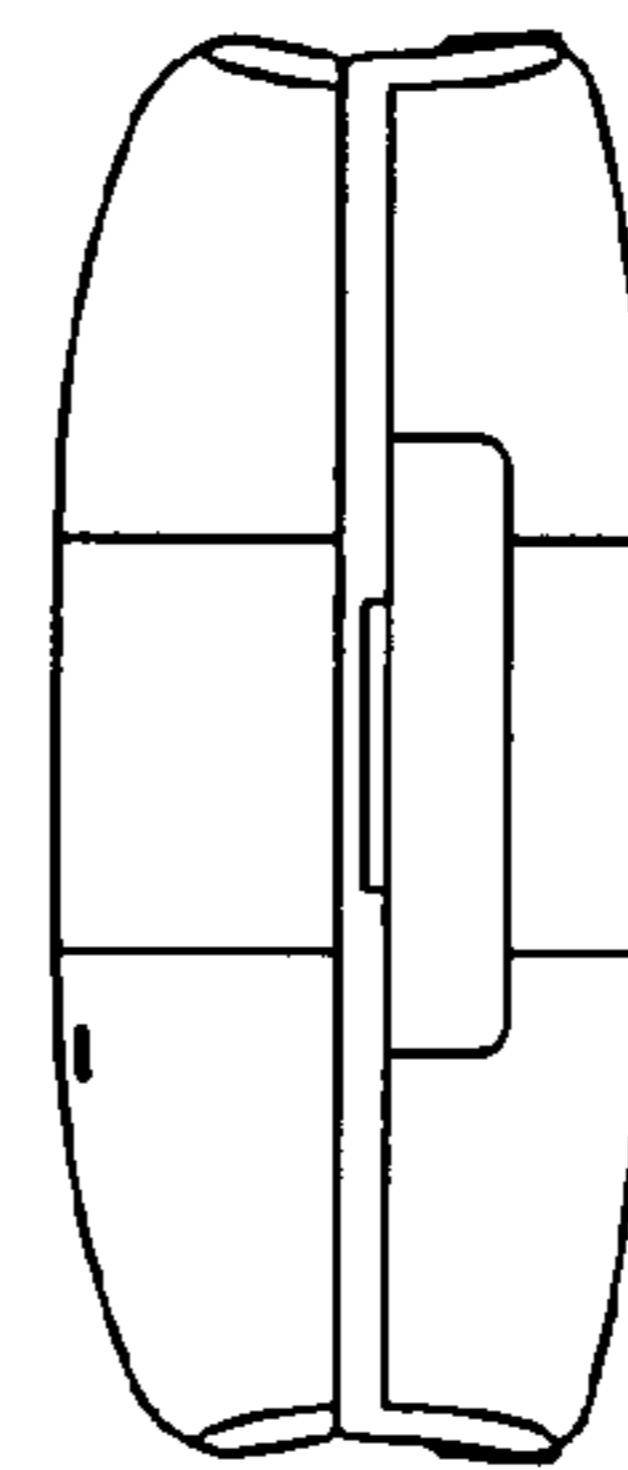

FIG. 8

