

US00D568281S

(12) **United States Design Patent** (10) **Patent No.:** **US D568,281 S**
Lee (45) **Date of Patent:** **** May 6, 2008**

- (54) **CELLULAR PHONE**
- (75) Inventor: **Young-Keun Lee**, Seoul (KR)
- (73) Assignee: **Samsung Electronics Co., Ltd.**, Suwon-Si (KR)
- (**) Term: **14 Years**
- (21) Appl. No.: **29/264,910**
- (22) Filed: **Aug. 22, 2006**
- (51) **LOC (8) Cl.** **14-03**
- (52) **U.S. Cl.** **D14/138**
- (58) **Field of Classification Search** D14/496, D14/138, 341-347; 455/575.3, 575.1; D21/517, D21/329, 333

See application file for complete search history.

(56) **References Cited**

U.S. PATENT DOCUMENTS

D321,865 S *	11/1991	Derocher	D14/345
5,260,998 A *	11/1993	Takagi	379/433.13
D352,503 S *	11/1994	Nagele	D14/138
5,436,954 A *	7/1995	Nishiyama et al.	455/566
D379,983 S *	6/1997	Shindou	D14/138
D383,731 S *	9/1997	Mieki et al.	D14/345
D430,566 S *	9/2000	Chu et al.	D14/345
D449,605 S *	10/2001	Schebesch et al.	D14/345
D462,959 S *	9/2002	O'Bradovich et al.	D14/345
D476,303 S *	6/2003	Lee et al.	D14/138
D482,030 S *	11/2003	Kataoka	D14/345
D488,154 S *	4/2004	Lovelady et al.	D14/345
D489,368 S *	5/2004	Yoneda et al.	D14/345
D502,701 S *	3/2005	Takuma	D14/345
D536,320 S *	2/2007	Michaels	D14/138
D542,764 S *	5/2007	Lee et al.	D14/138
D543,172 S *	5/2007	Lee et al.	D14/138
D546,307 S *	7/2007	Lee	D14/138
D546,804 S *	7/2007	Lee et al.	D14/138
D551,200 S *	9/2007	Escorcia et al.	D14/138
D551,643 S *	9/2007	Kim et al.	D14/138
D552,583 S *	10/2007	Choi et al.	D14/138
2005/0227747 A1 *	10/2005	Song	455/575.3
2005/0233708 A1 *	10/2005	Im et al.	455/90.3
2006/0135225 A1 *	6/2006	Lin et al.	455/575.3

2007/0191077 A1* 8/2007 Shin 455/575.3

OTHER PUBLICATIONS

Samsung U300 telephone, announced Feb. 2007, [online], [site visited Dec. 16, 2007]. Available from Internet ,<URL: http://www.gsmarena.com>.*

Nokia N92 telephone, announced 4th quarter 2005, [online], [site visited Dec. 16, 2007]. Available from Internet ,<URL: http://www.gsmarena.com>.*

Samsung D700, announced 3rd quarter 2003, [online], [site visited Dec. 16, 2007]. Available from Internet ,<URL: http://www.gsmarena.com>.*

NEC e949/L1, announced 2nd quarter 2005, [online], [site visited Dec. 16, 2007]. Available from Internet ,<URL: http://www.gsmarena.com>.*

* cited by examiner

Primary Examiner—Jeffrey Asch

(74) *Attorney, Agent, or Firm*—Staas & Halsey LLP

(57) **CLAIM**

The ornamental design for a cellular phone, as shown and described.

DESCRIPTION

FIG. 1 is a perspective view of a cellular phone according to my new design with its front closed;

FIG. 2 is a front elevational view thereof;

FIG. 3 is a rear elevational view thereof;

FIG. 4 is a left side elevational view thereof;

FIG. 5 is a right side elevational view thereof;

FIG. 6 is a top plan view thereof;

FIG. 7 is a bottom plan view thereof;

FIG. 8 is a perspective view of the cellular phone according to my new design with its front opened; and,

FIG. 9 is a perspective view of the cellular phone according to my new design with its front opened and rotated.

The surface(s) or portion(s) of the article not shown in the drawing or described in the specification form(s) no part of the claimed design.

1 Claim, 9 Drawing Sheets

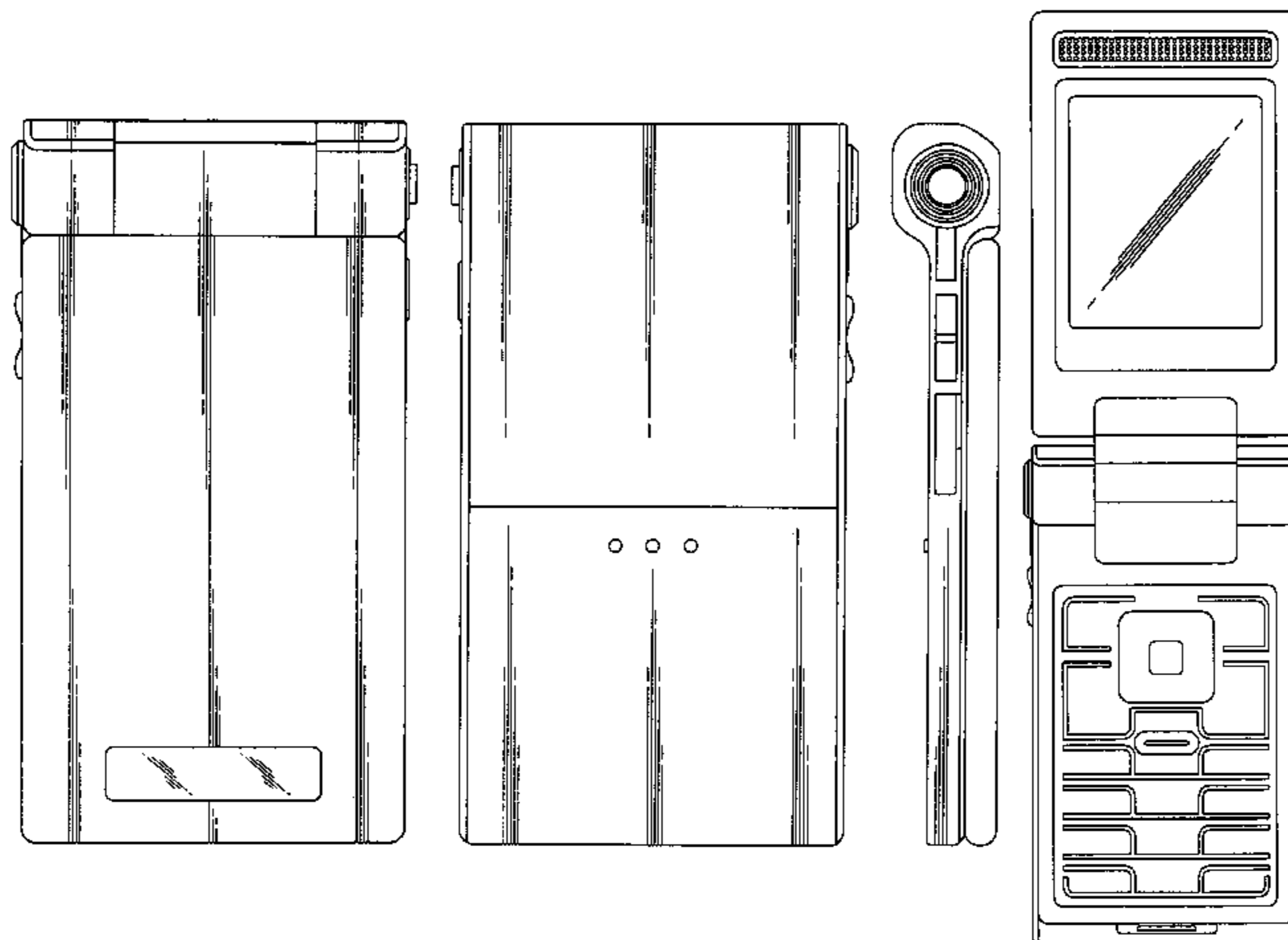

FIG. 1

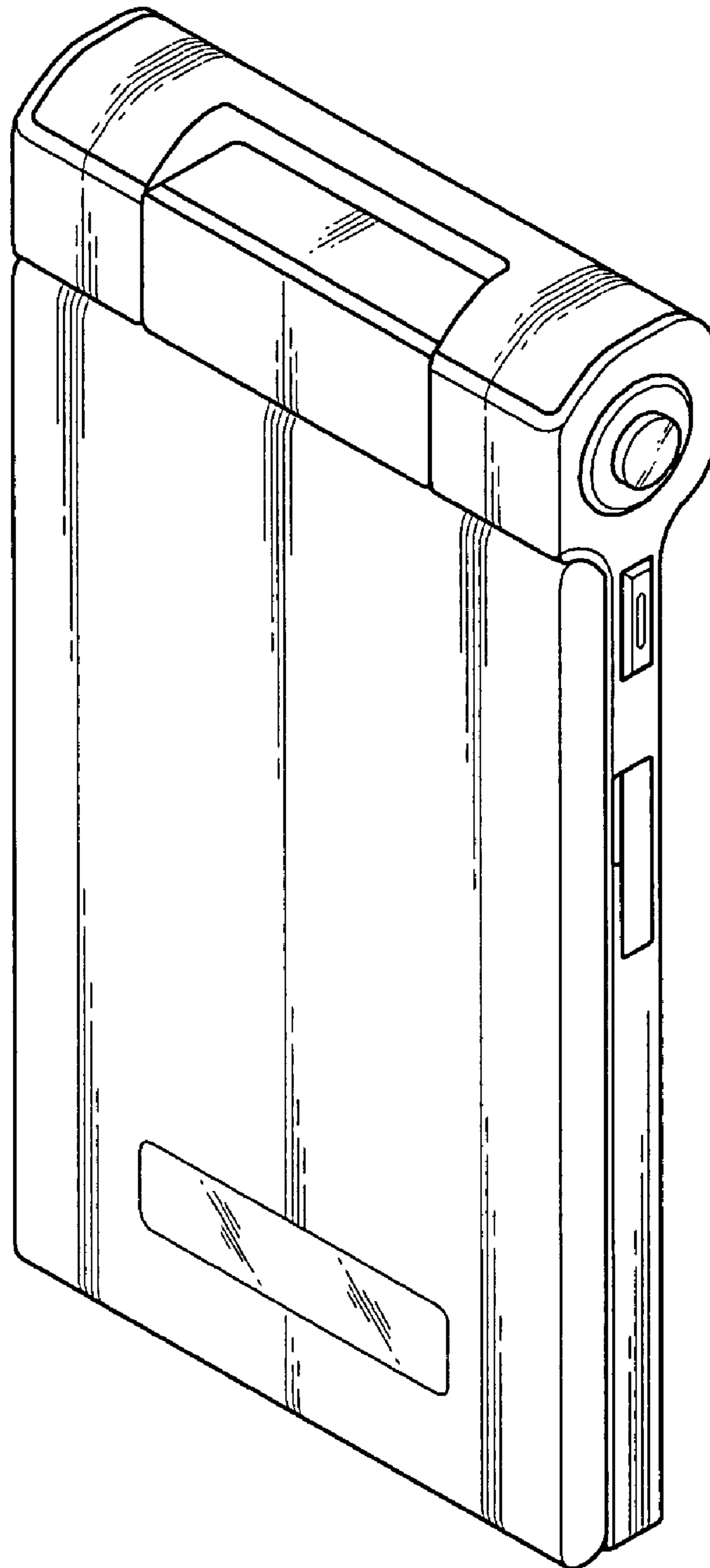

FIG.2

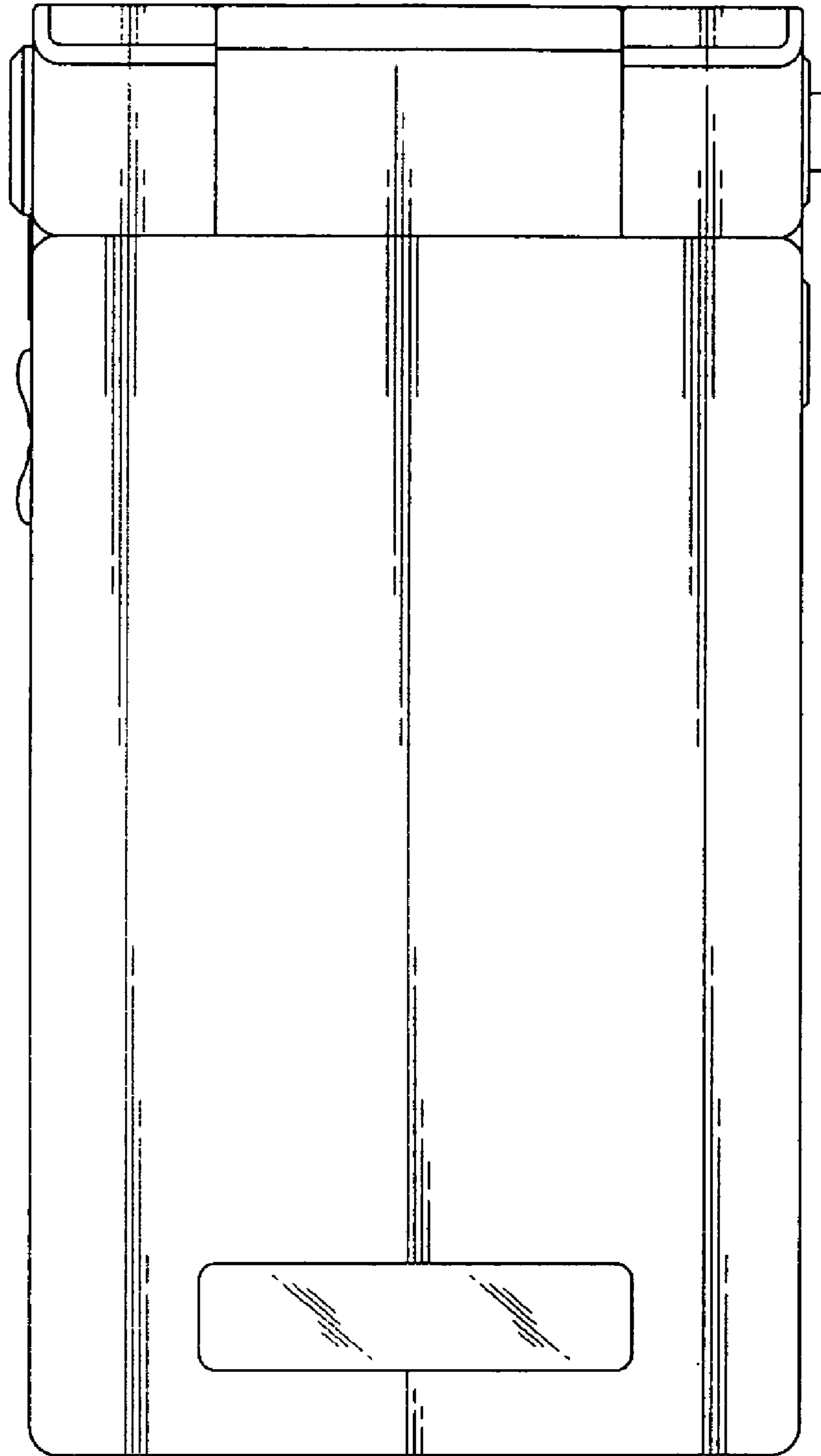

FIG.3

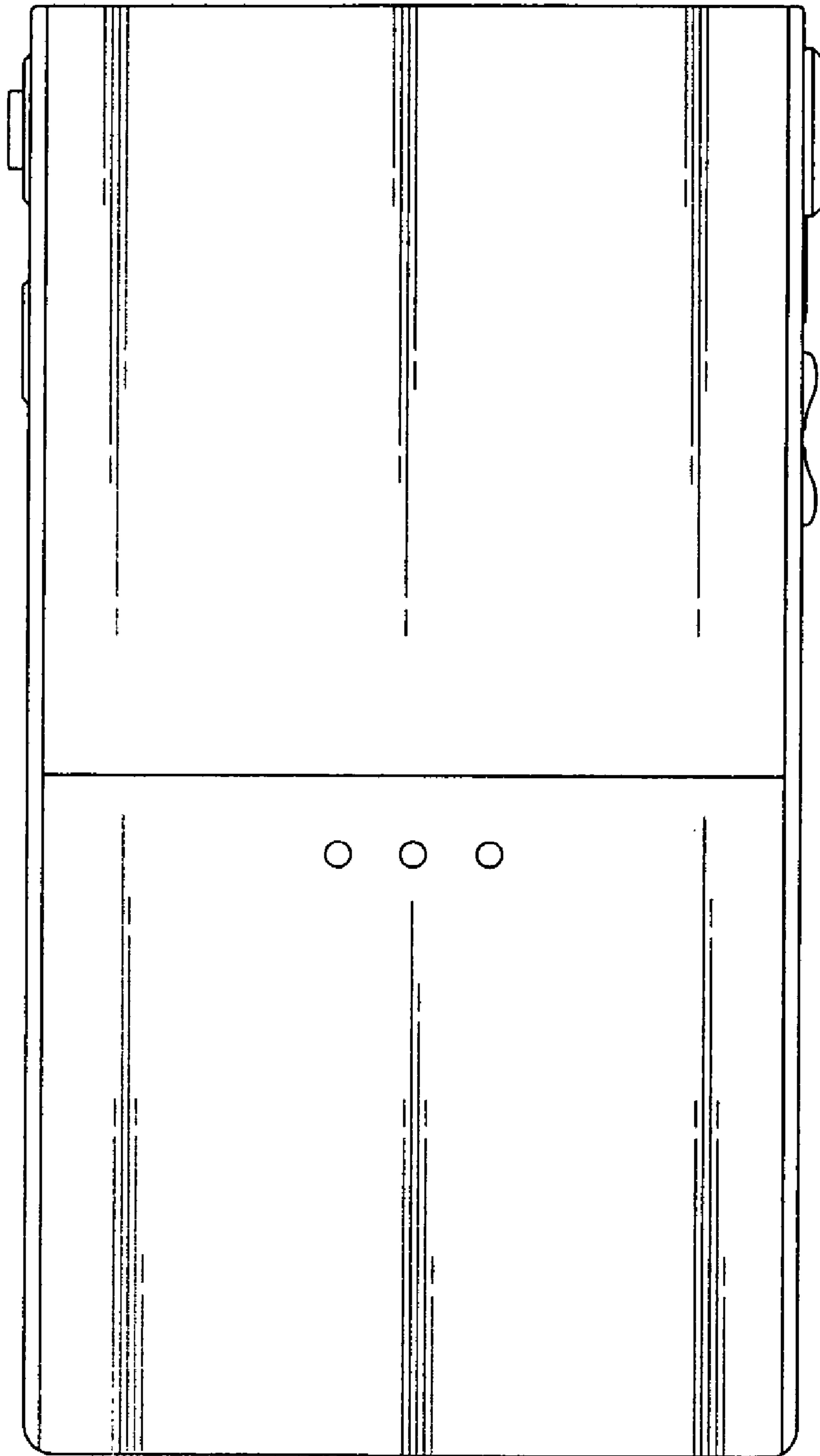

FIG.4

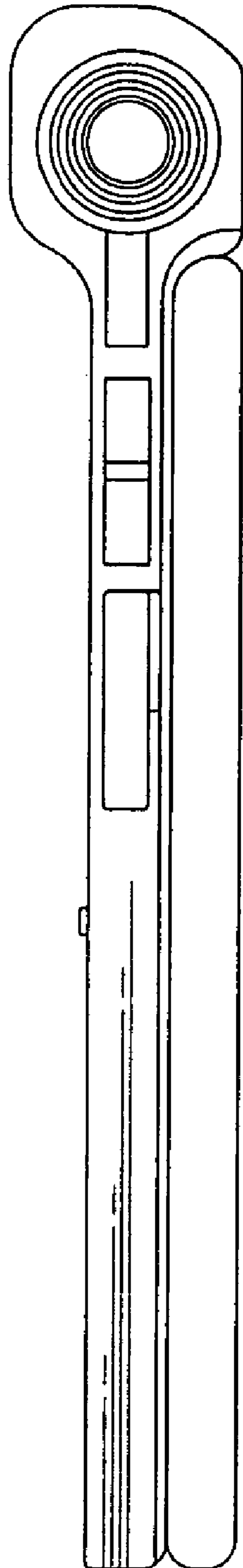

FIG. 5

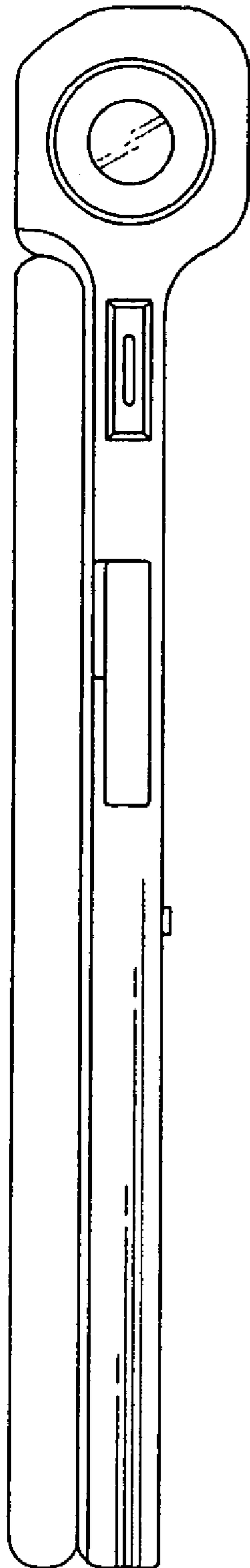

FIG.6



FIG. 7

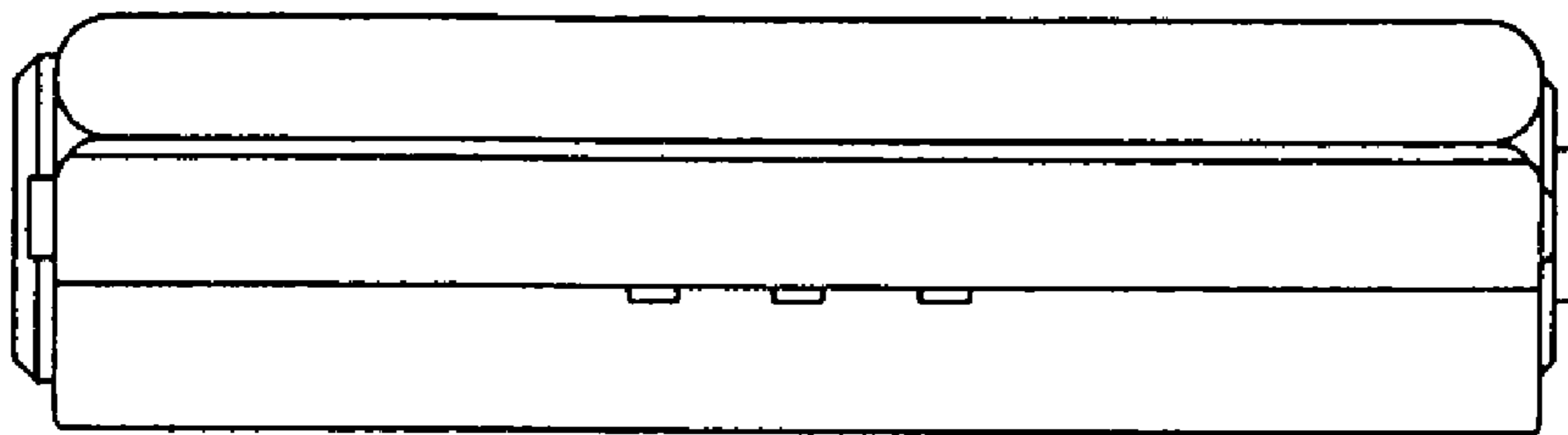

FIG.8

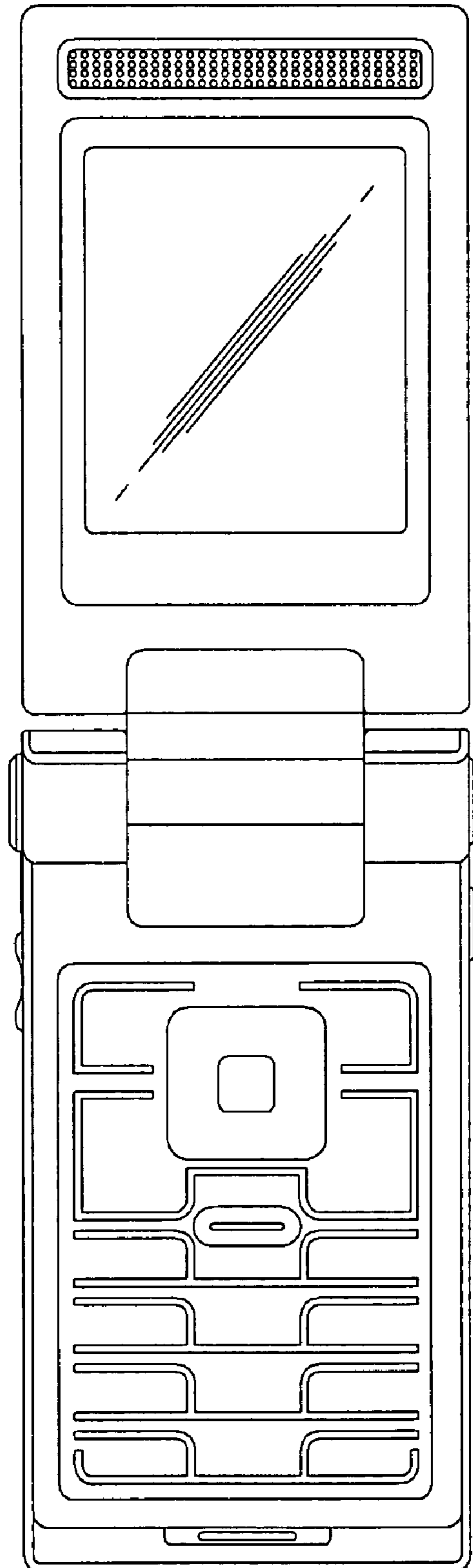

FIG.9

