

US00D568273S

(12) **United States Design Patent**
Lee

(10) **Patent No.:** **US D568,273 S**

(45) **Date of Patent:** **** May 6, 2008**

(54) **DVD PLAYER**

(75) Inventor: **Chull Lee**, Seoul (KR)

(73) Assignee: **LG Electronics Inc.**, Seoul (KR)

(**) Term: **14 Years**

(21) Appl. No.: **29/263,557**

(22) Filed: **Jul. 26, 2006**

(30) **Foreign Application Priority Data**

Jan. 26, 2006 (KR) 30-2006-0003282

(51) **LOC (8) Cl.** **14-03**

(52) **U.S. Cl.** **D14/132**

(58) **Field of Classification Search** D14/125-134,
D14/239, 371, 136, 374-377; 312/7.2; 348/836,
348/838, 180, 184, 325, 739; 341/12; 248/917-924,
248/465; 345/104, 133, 156, 168, 87, 173;
720/605, 669, 600, 655; 369/99, 197; 455/344-347
See application file for complete search history.

(56) **References Cited**

U.S. PATENT DOCUMENTS

- D447,738 S * 9/2001 Usami et al. D14/136
- D484,472 S * 12/2003 Isshiki D14/132
- D501,833 S * 2/2005 Peng D14/129
- D501,835 S * 2/2005 Peng D14/129
- D531,970 S * 11/2006 Tsai et al. D14/129

- D534,513 S * 1/2007 Peng D14/132
- D535,955 S * 1/2007 Peng D14/129
- D552,052 S * 10/2007 Liang et al. D14/132
- 2004/0212957 A1 * 10/2004 Schedivy 361/683
- 2004/0218517 A1 * 11/2004 Yano et al. 369/292
- 2005/0025466 A1 * 2/2005 Yen et al. 386/125

* cited by examiner

Primary Examiner—Raphael Barkai

(74) *Attorney, Agent, or Firm*—Birch, Stewart, Kolasch, Birch, LLP

(57) **CLAIM**

The ornamental design for a DVD player, as shown and described.

DESCRIPTION

FIG. 1 is a front, right perspective view of the DVD player showing my new design;

FIG. 2 is a front view thereof;

FIG. 3 is a rear view thereof;

FIG. 4 is a left side view thereof;

FIG. 5 is a right side view thereof;

FIG. 6 is a top plan view thereof;

FIG. 7 is a bottom plan view thereof; and,

FIG. 8 is a reference view thereof.

1 Claim, 4 Drawing Sheets

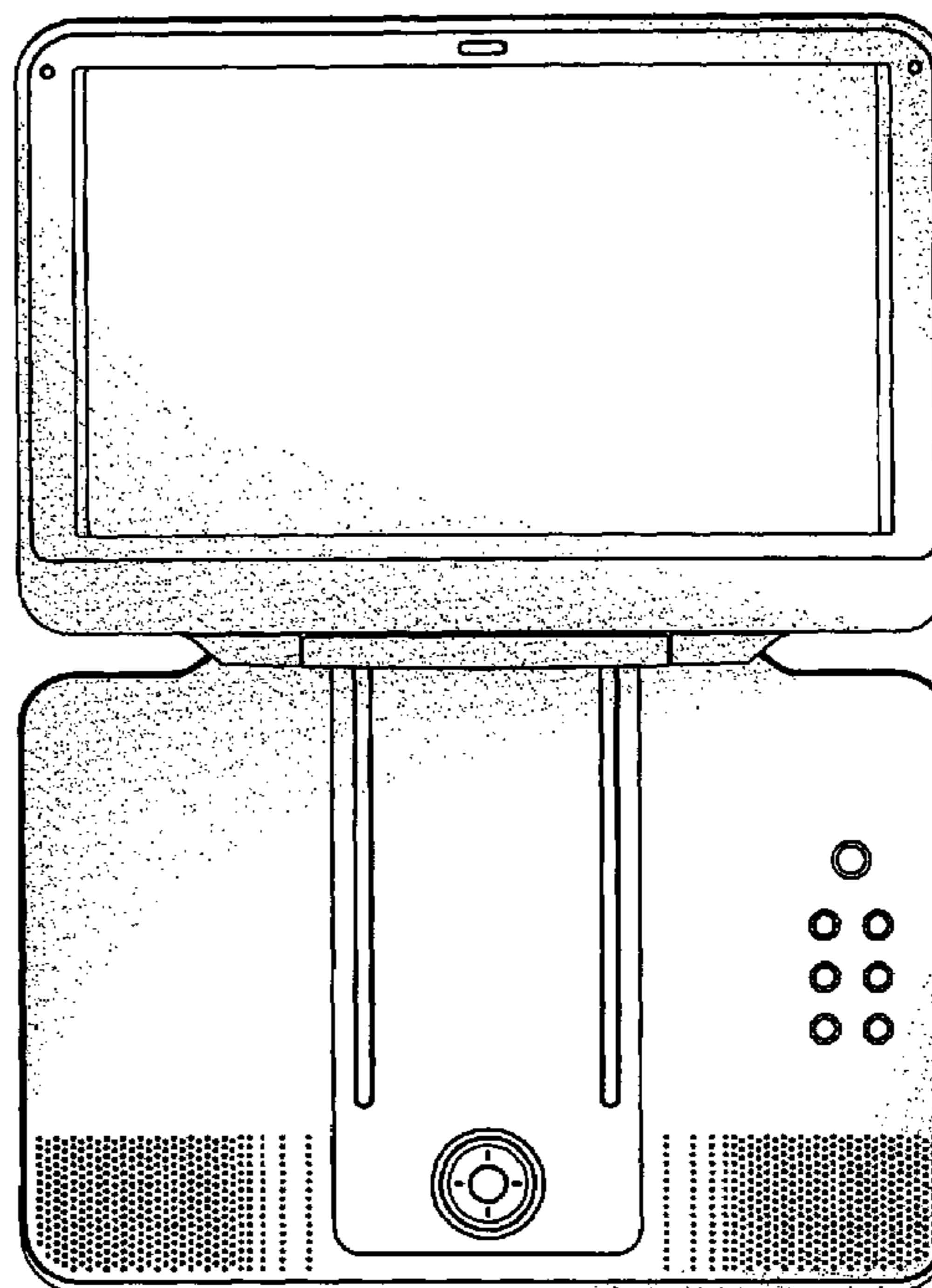
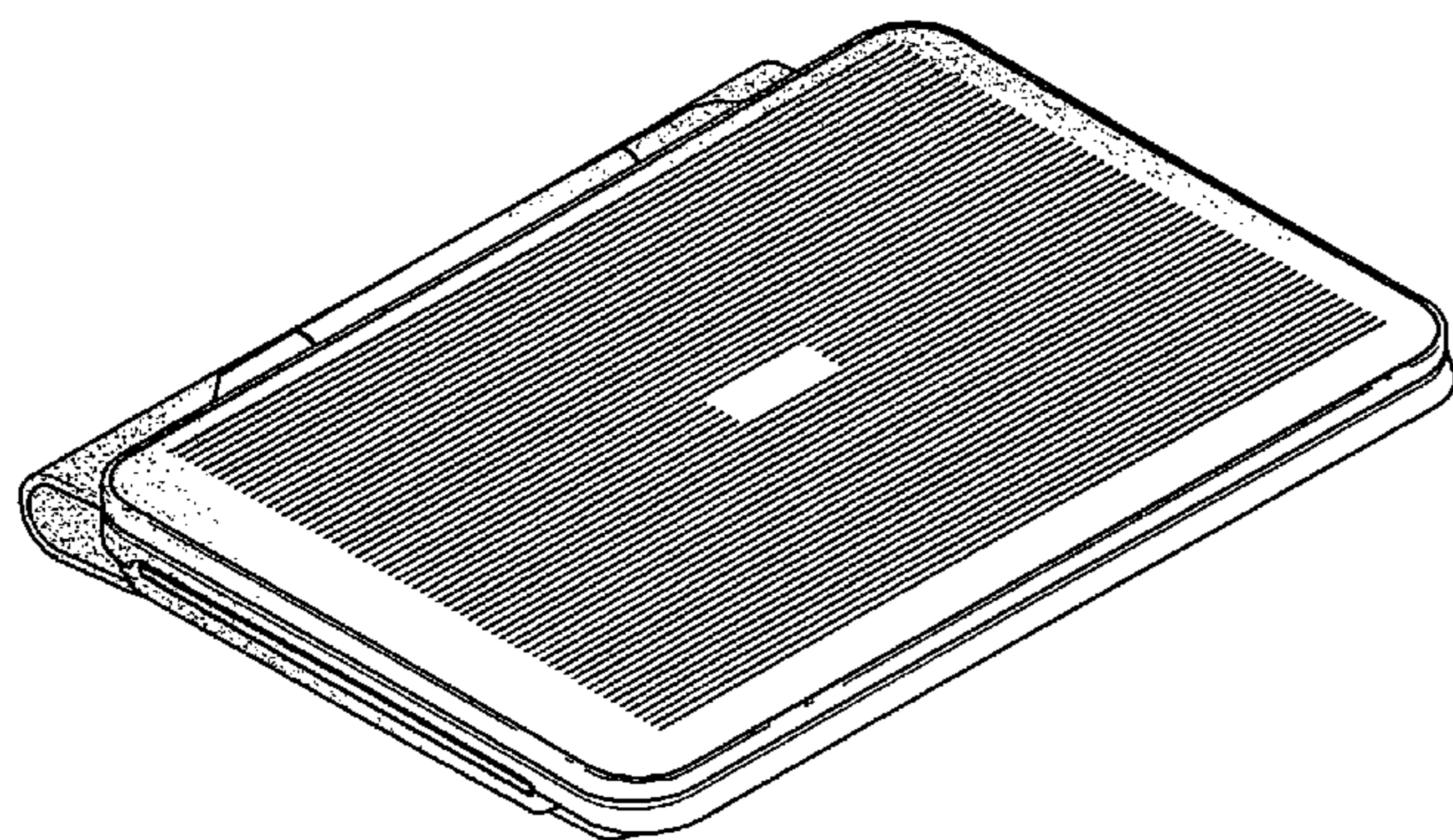

Fig. 1

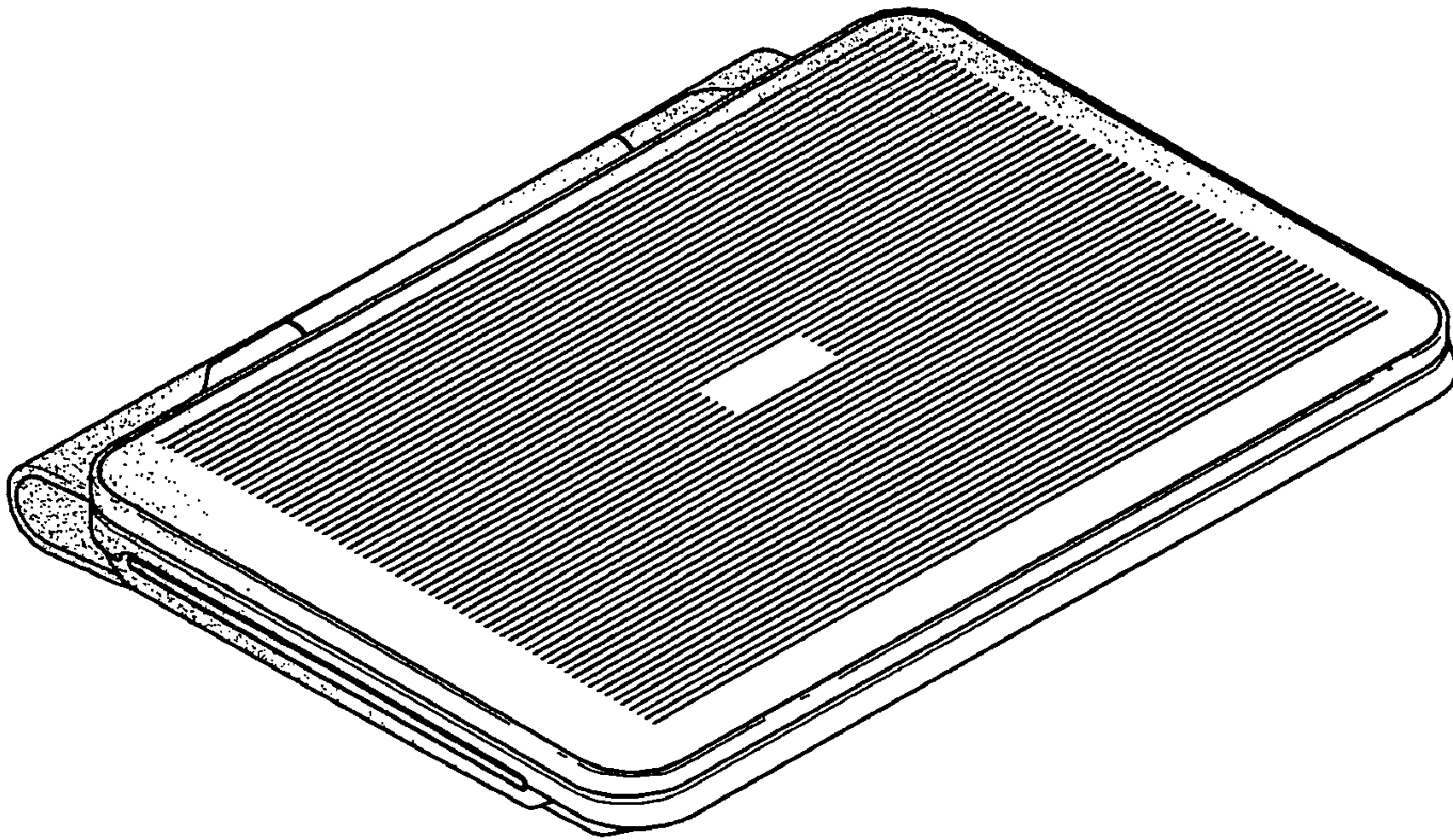

Fig. 2

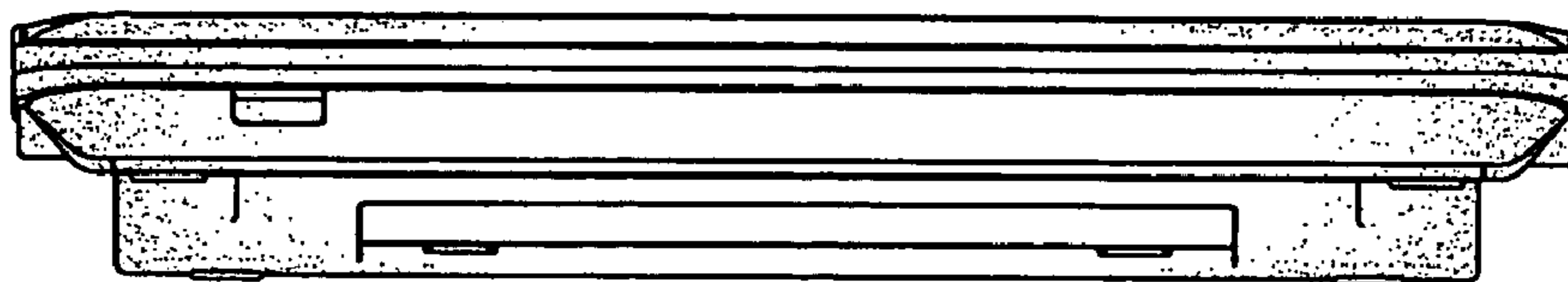

Fig. 3

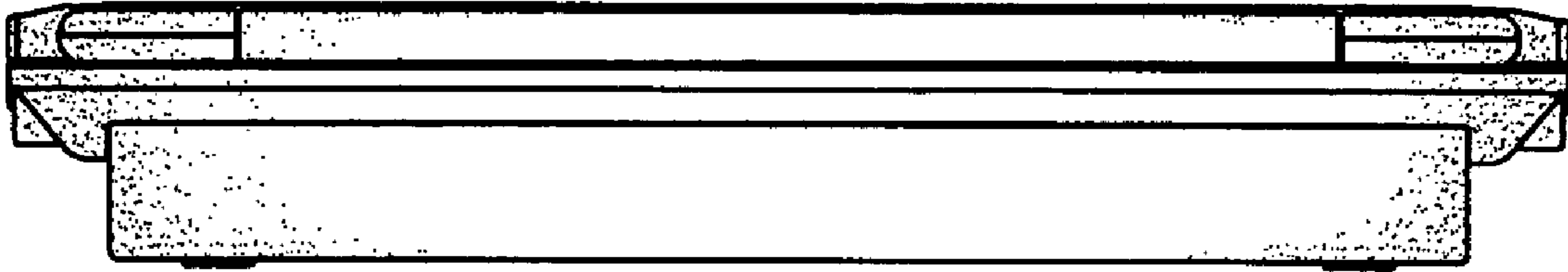

Fig. 4

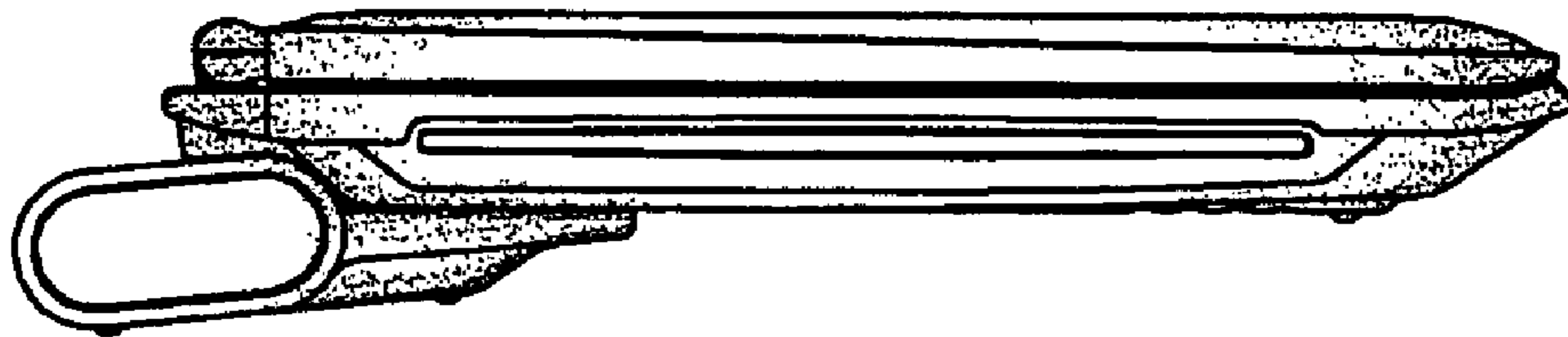

Fig. 5

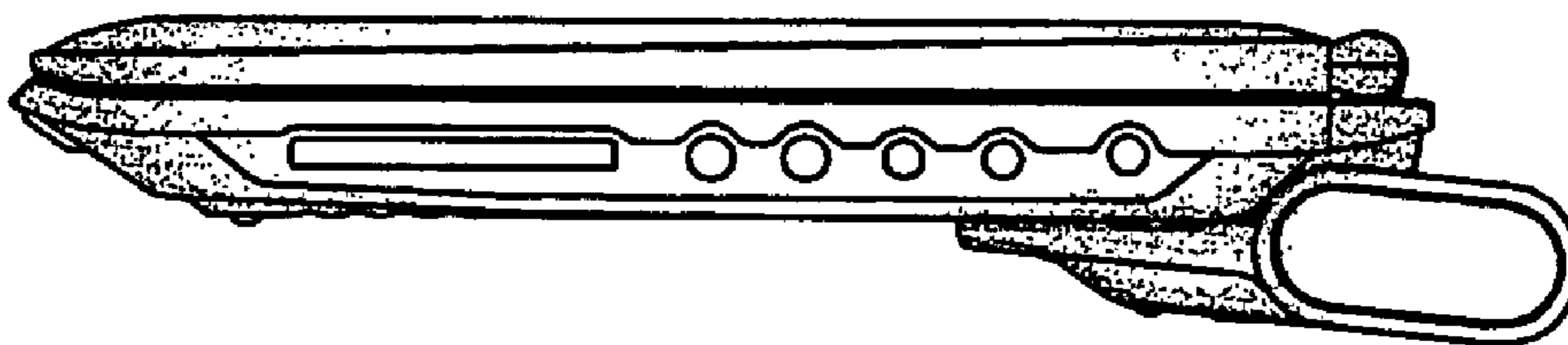

Fig. 6

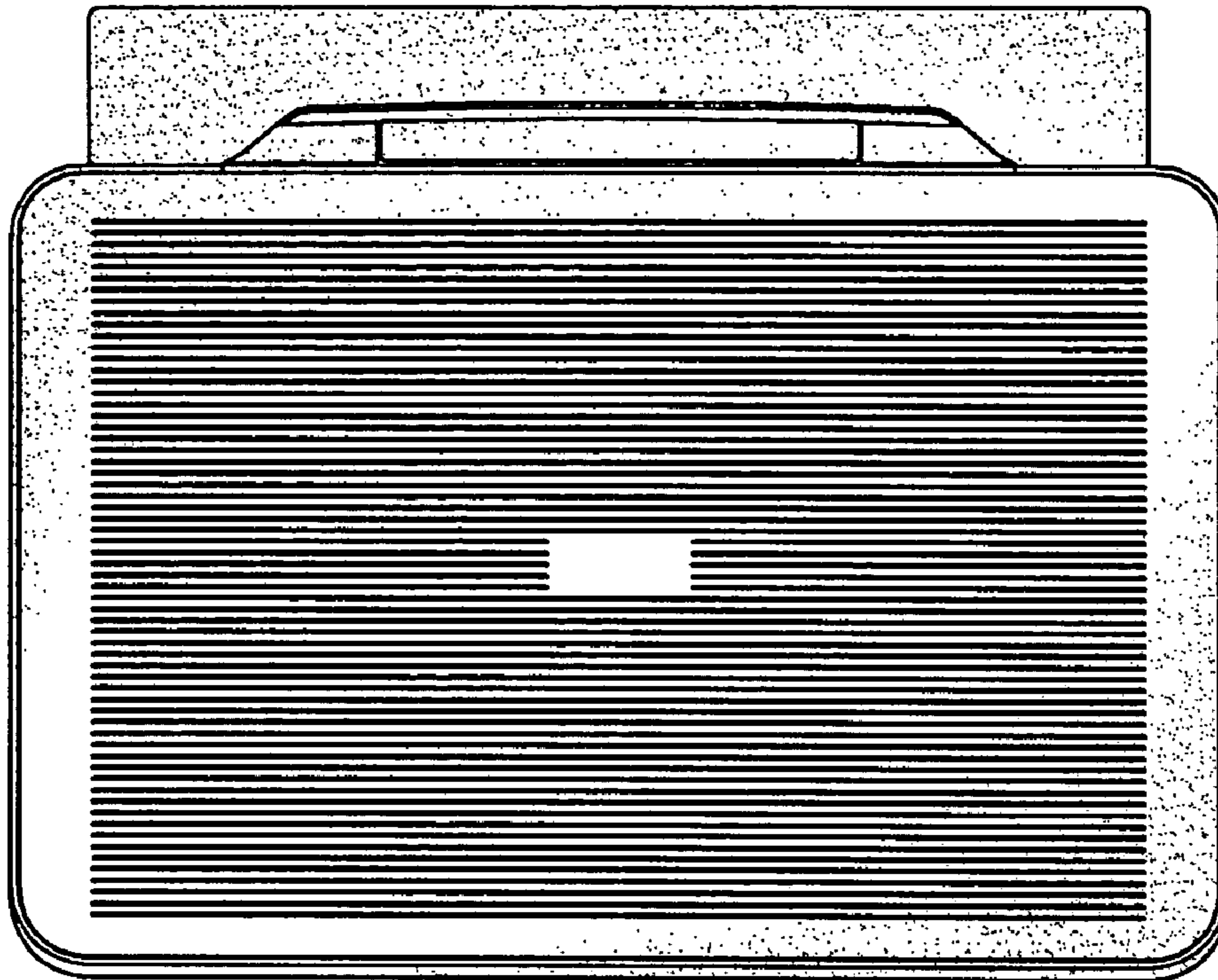

Fig. 7

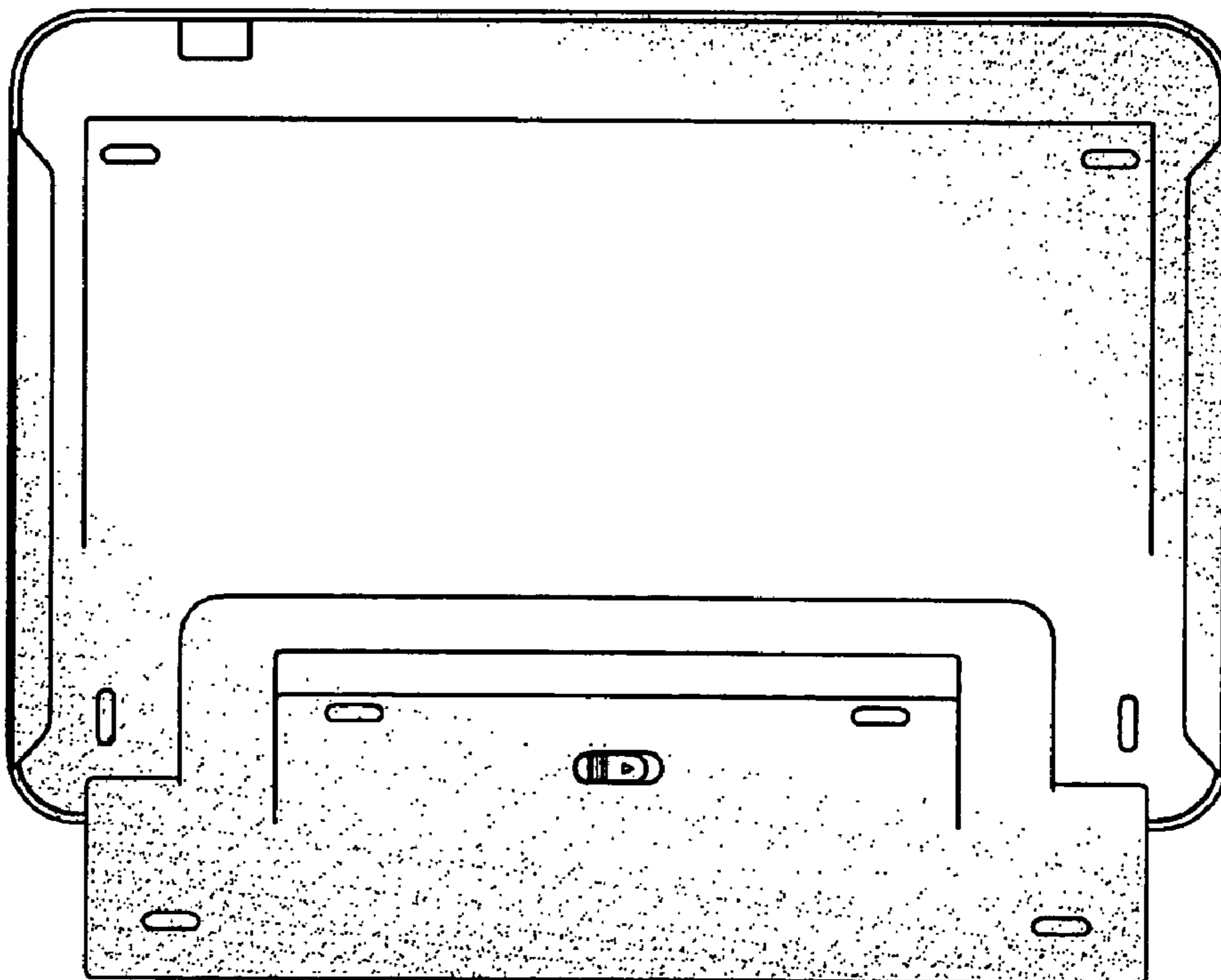

Fig. 8

