

US00D568271S

(12) **United States Design Patent**  
**Lee**

(10) **Patent No.:** **US D568,271 S**  
(45) **Date of Patent:** **\*\* May 6, 2008**

(54) **PORTABLE DVD PLAYER**

(57) **CLAIM**

(75) Inventor: **Johann Lee**, Maspeth, NY (US)

I claim the ornamental design of a portable DVD player, as shown and described.

(73) Assignee: **Coby Electronics Corp.**, Maspeth, NY (US)

**DESCRIPTION**

(\*\*) Term: **14 Years**

FIG. 1 is a perspective view of a portable DVD player according to an embodiment of my new design (in open position);

(21) Appl. No.: **29/244,732**

FIG. 2 is a perspective view thereof (in closed position);

(22) Filed: **Dec. 14, 2005**

FIG. 3 is a top plan view thereof;

(51) **LOC (8) Cl.** ..... **14-03**

FIG. 4 is a bottom plan view thereof;

(52) **U.S. Cl.** ..... **D14/132**

FIG. 5 is a left side elevation view thereof;

(58) **Field of Classification Search** ..... D14/125-134, D14/239, 371, 136, 374-377; 312/7.2; 348/836, 348/838, 180, 184, 325, 739; 341/12; 248/917-924, 248/465; 345/104, 133, 156, 168, 87, 173; 720/605, 669, 600, 655; 369/99, 197; 455/344-347  
See application file for complete search history.

FIG. 6 is a right side elevation view thereof;

FIG. 7 is a front elevation view thereof;

FIG. 8 is a back elevation view thereof;

FIG. 9 is a perspective view of a portable DVD player according to another embodiment of my new design (in open position);

(56) **References Cited**

**U.S. PATENT DOCUMENTS**

5,870,367	A	2/1999	Yamamori	
D410,463	S	6/1999	Hattori	
D447,738	S *	9/2001	Usami et al.	D14/136
D491,904	S	6/2004	Johansson et al.	
D499,388	S	12/2004	Murakami	
D501,833	S *	2/2005	Peng	D14/129
D501,834	S *	2/2005	Peng	D14/129
D502,453	S *	3/2005	Peng	D14/129
D512,977	S	12/2005	Chan	
D534,513	S *	1/2007	Peng	D14/132
D537,053	S *	2/2007	Peng	D14/129
D552,052	S *	10/2007	Liang et al.	D14/132
2004/0212957	A1 *	10/2004	Schedivy	361/683

FIG. 10 is a perspective view thereof (in closed position);

FIG. 11 is a top plan view thereof;

FIG. 12 is a bottom plan view thereof;

FIG. 13 is a left side elevation view thereof;

FIG. 14 is a right side elevation view thereof;

FIG. 15 is a front elevation view thereof; and,

FIG. 16 is a back elevation view thereof.

A portion of this patent document contains material which is subject to copyright protection. The copyright owner has no objection to the facsimile reproduction by anyone of the patent document or the patent disclosure, as it appears in the Patent and Trademark Office patent files or records, but otherwise reserves all copyrights whatsoever.

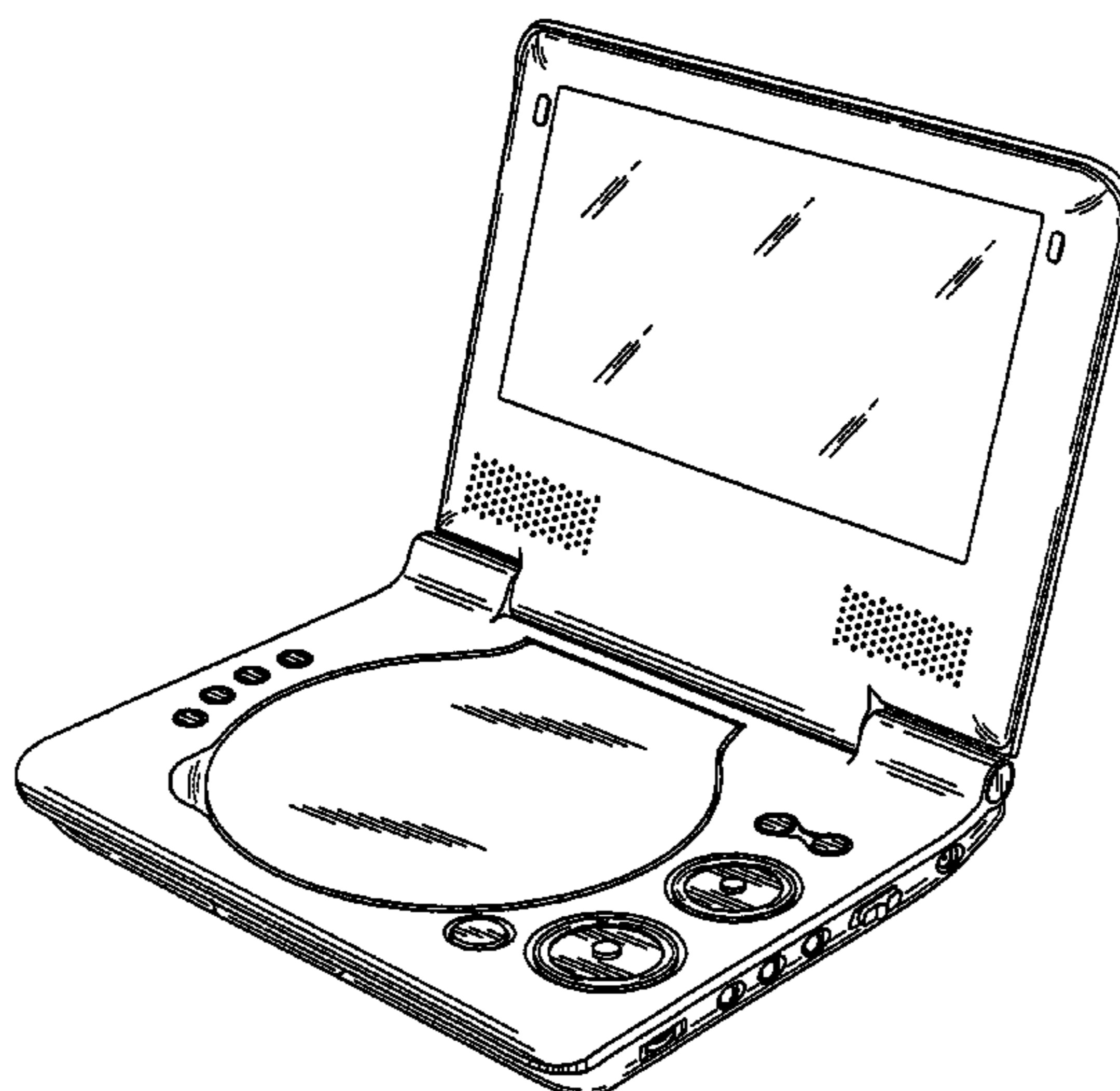
\* cited by examiner

Portions in broken lines are for illustrative purposes only and form no part of the claimed design.

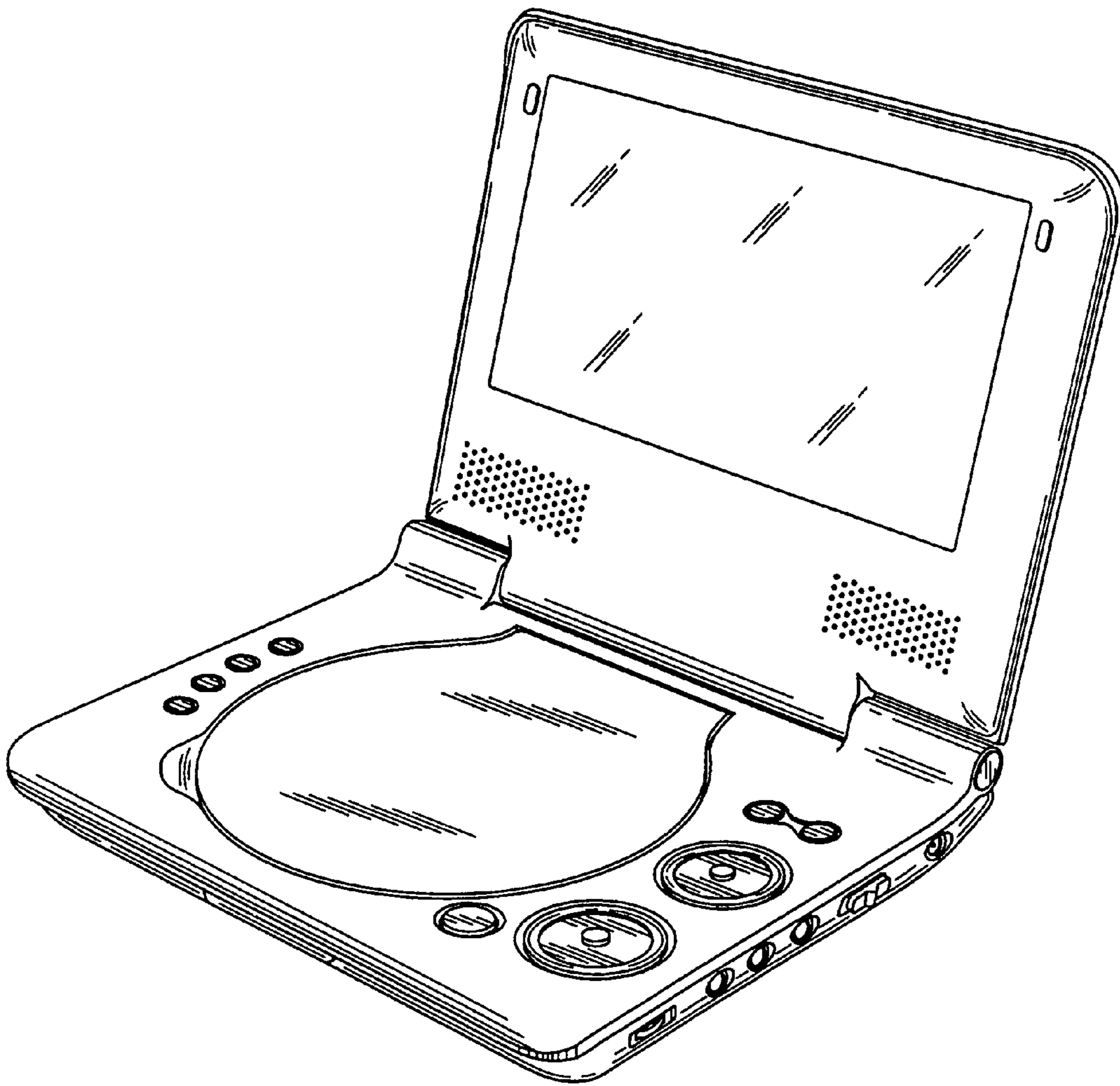
*Primary Examiner*—Raphael Barkai

(74) *Attorney, Agent, or Firm*—Mayer Brown LLP

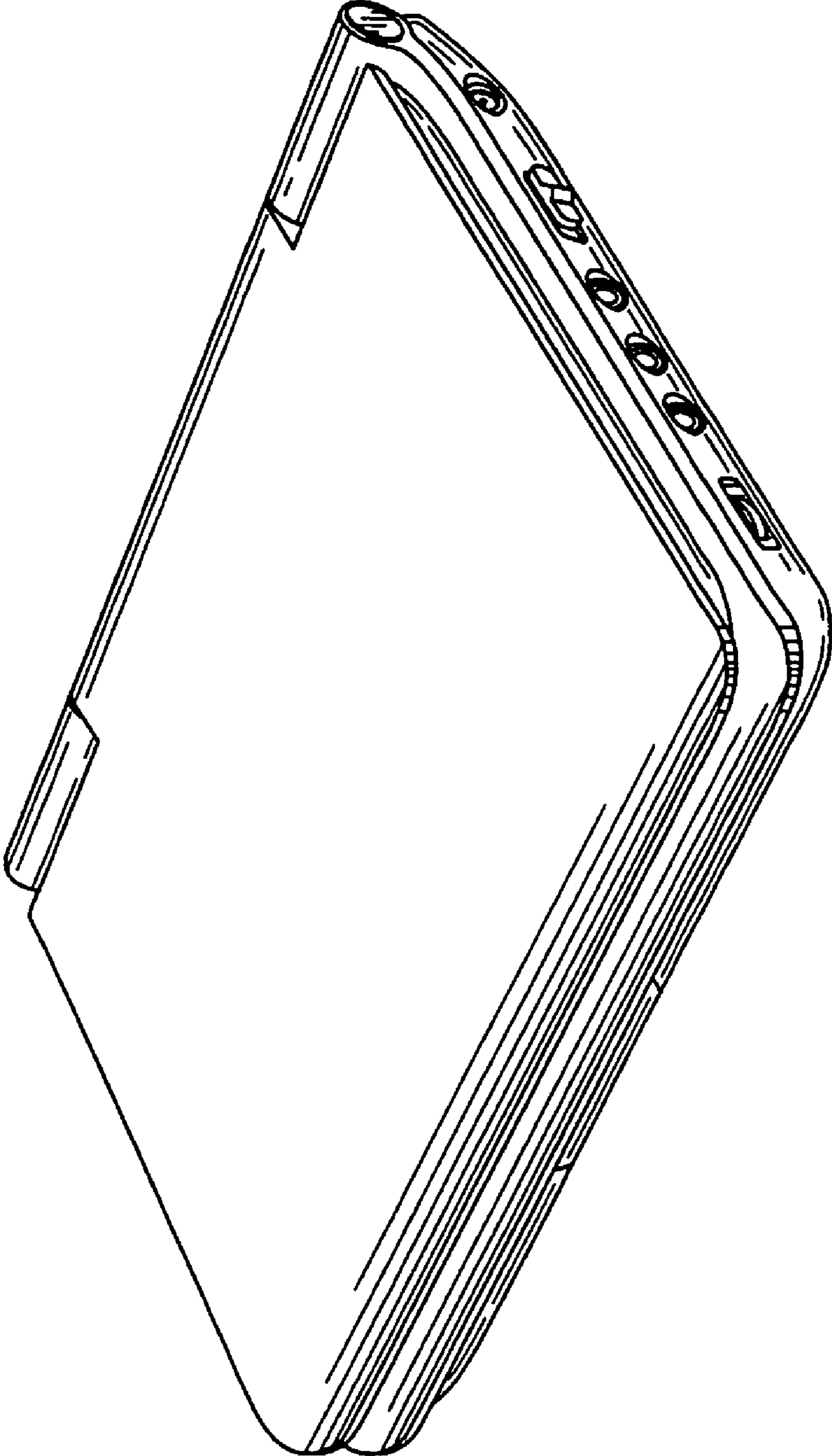
**1 Claim, 10 Drawing Sheets**



*FIG. 1*



*FIG. 2*



*FIG. 3*

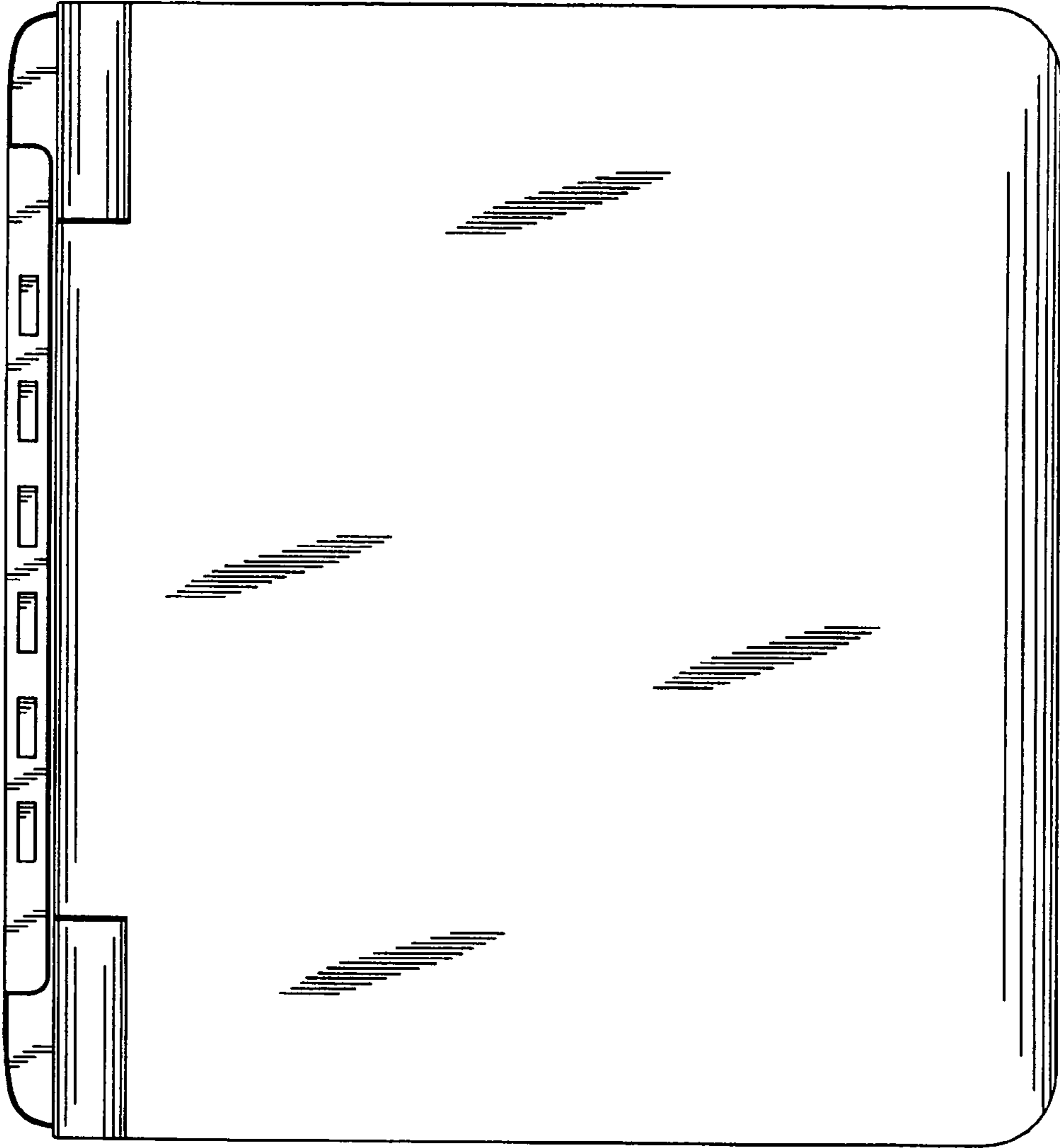
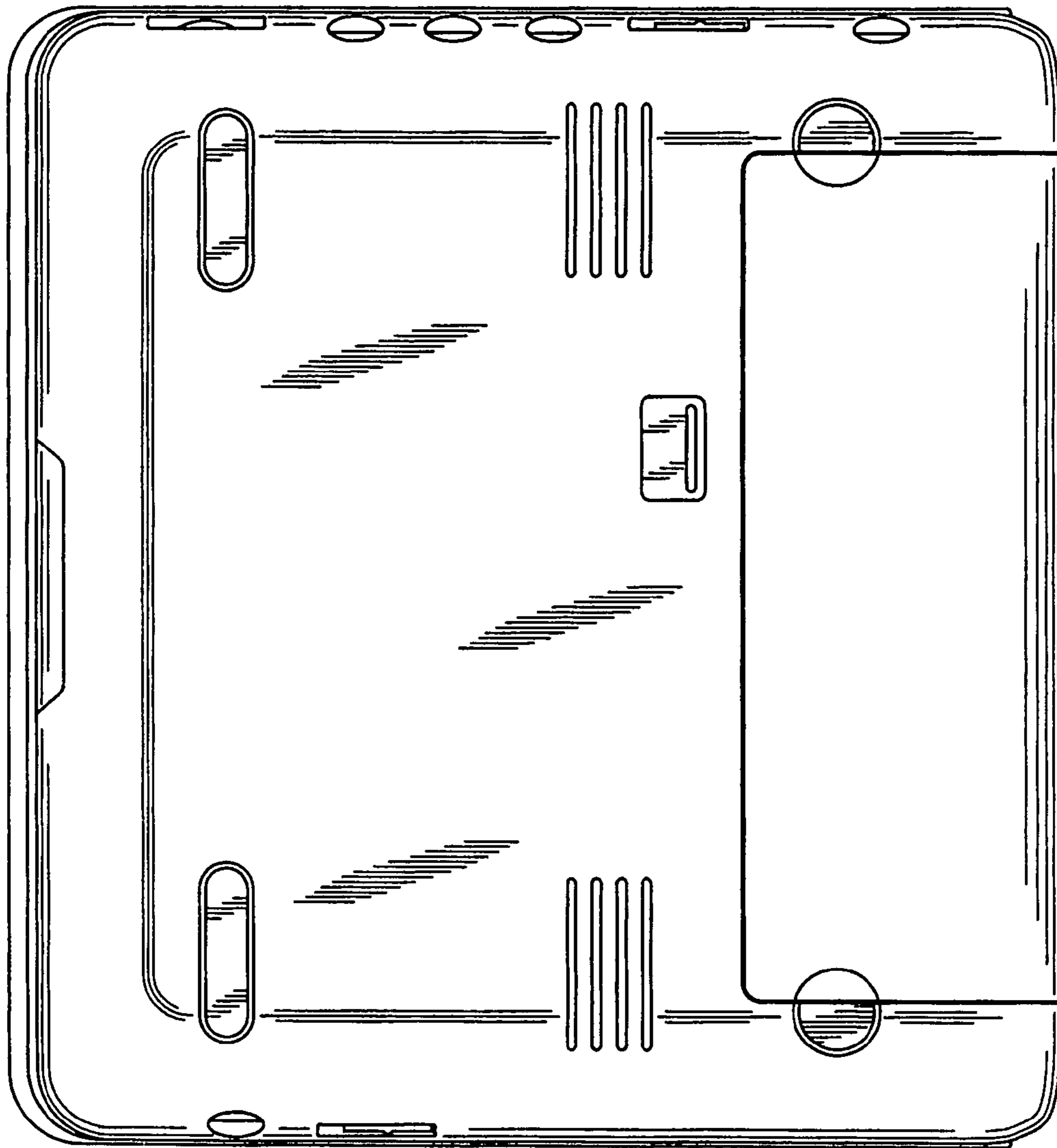
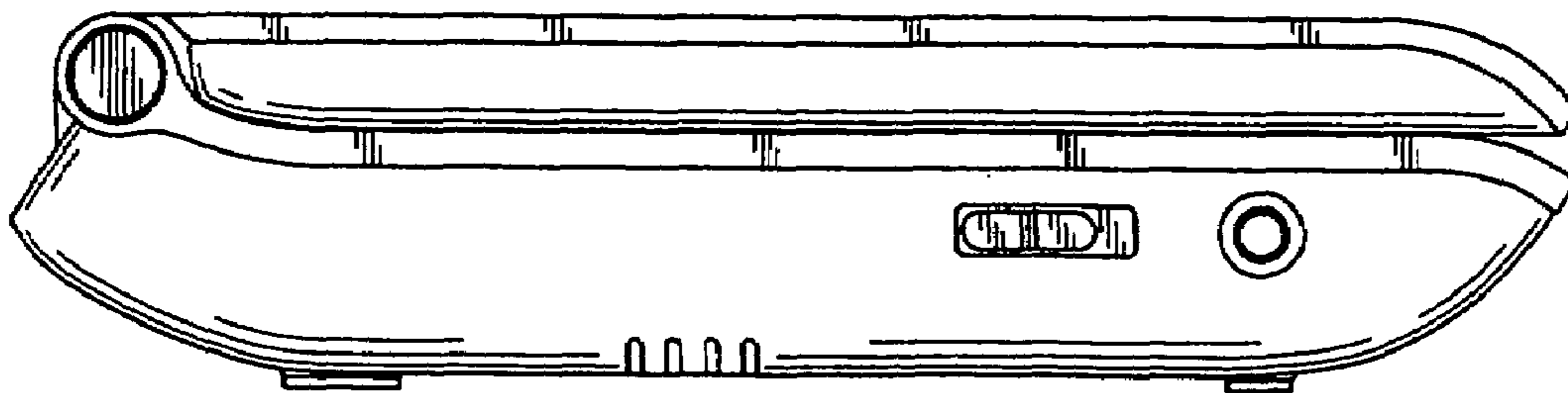


FIG. 4

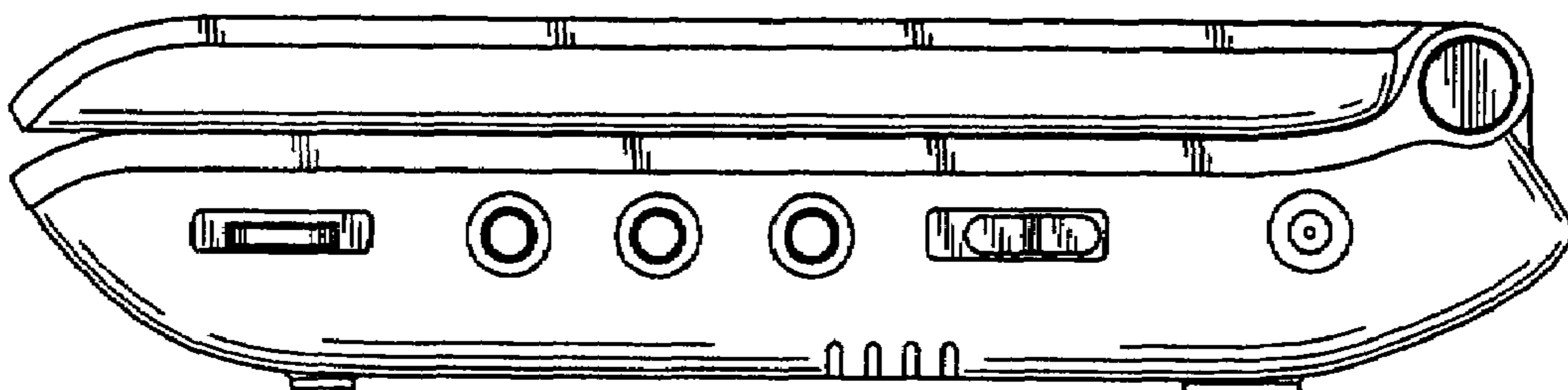




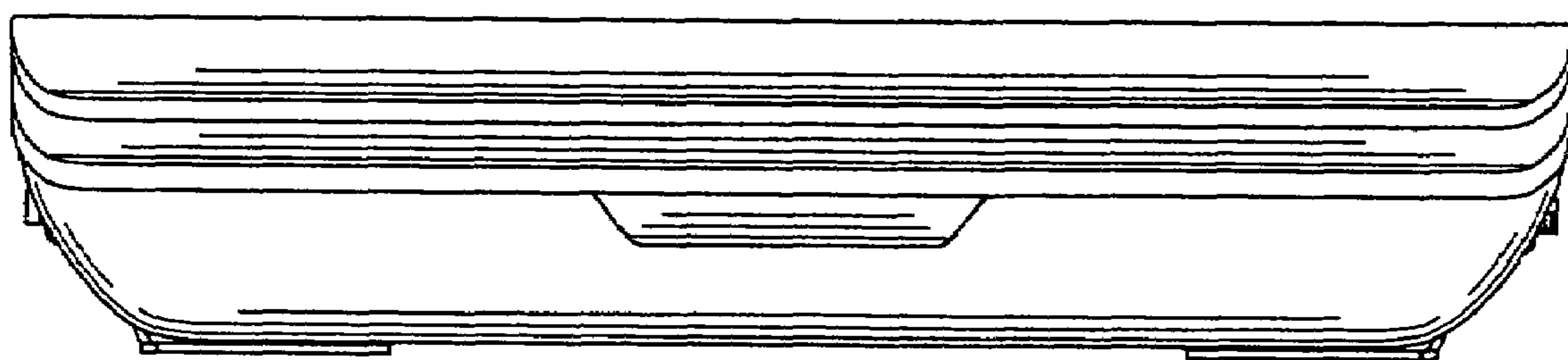
*FIG. 5*



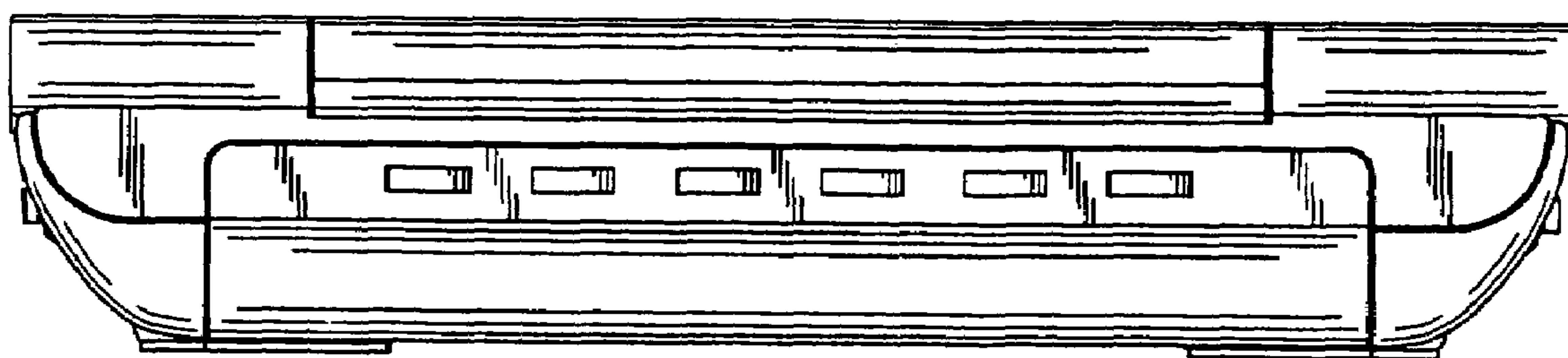
*FIG. 6*



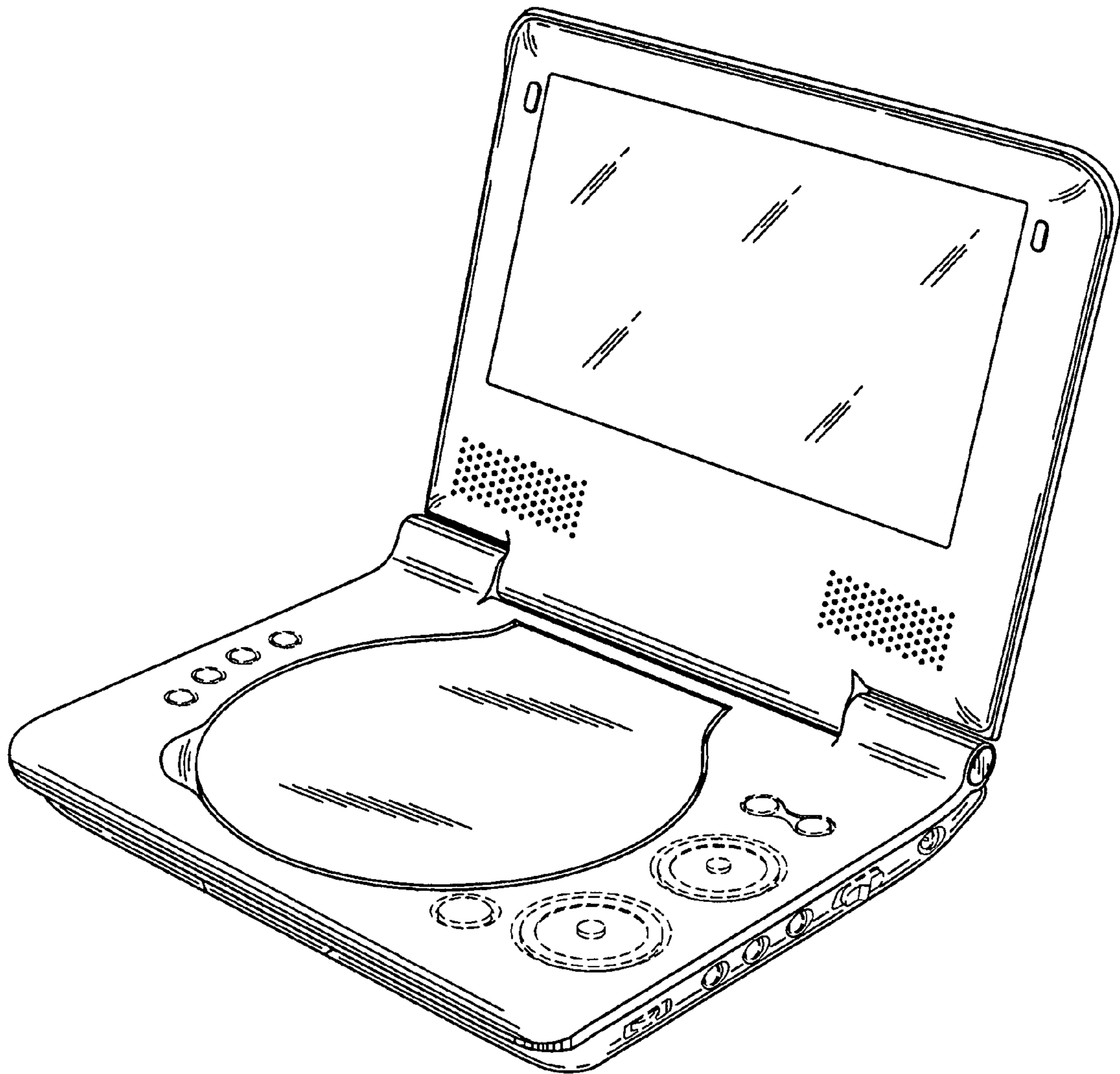
*FIG. 7*



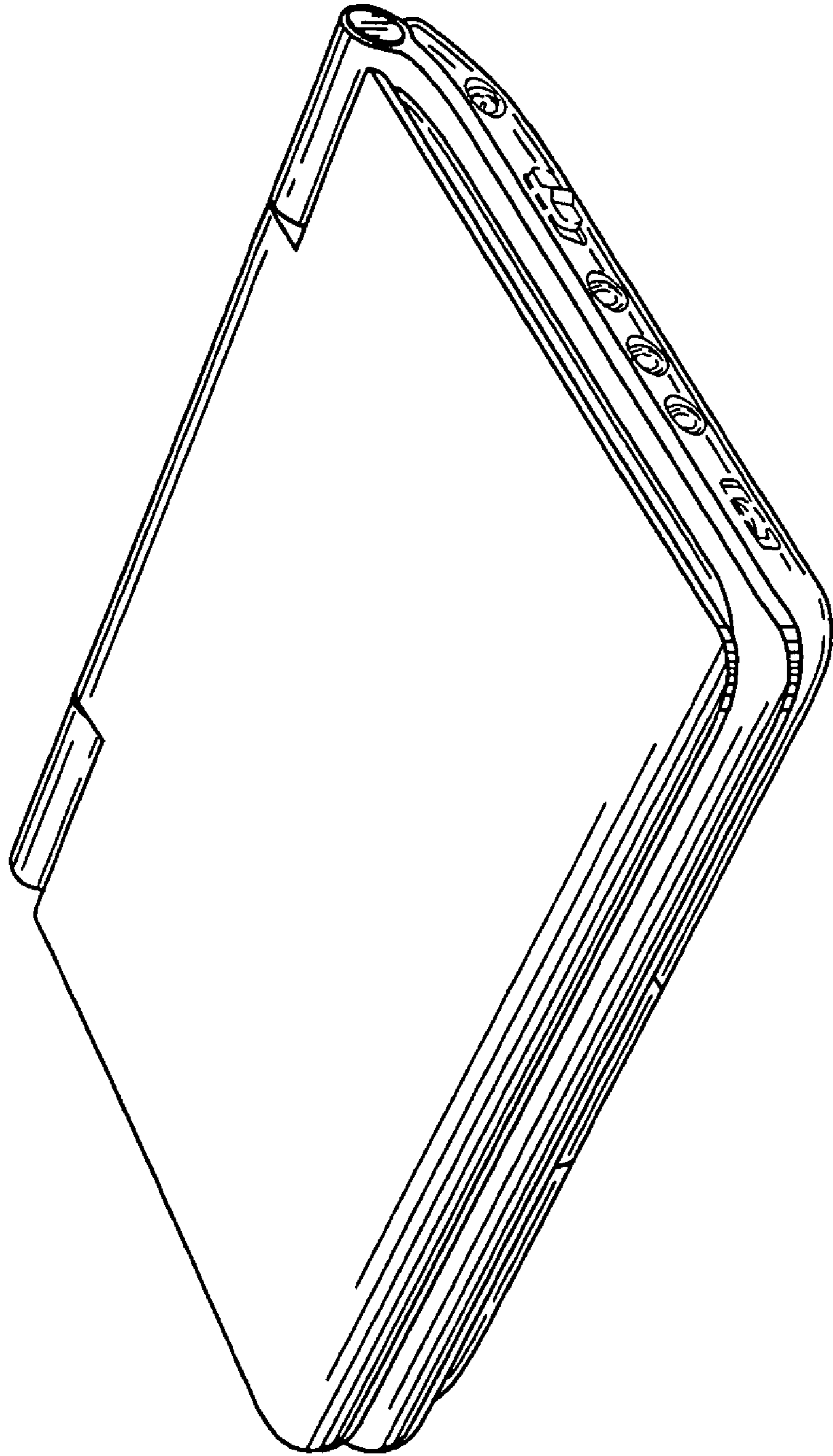
*FIG. 8*



*FIG. 9*

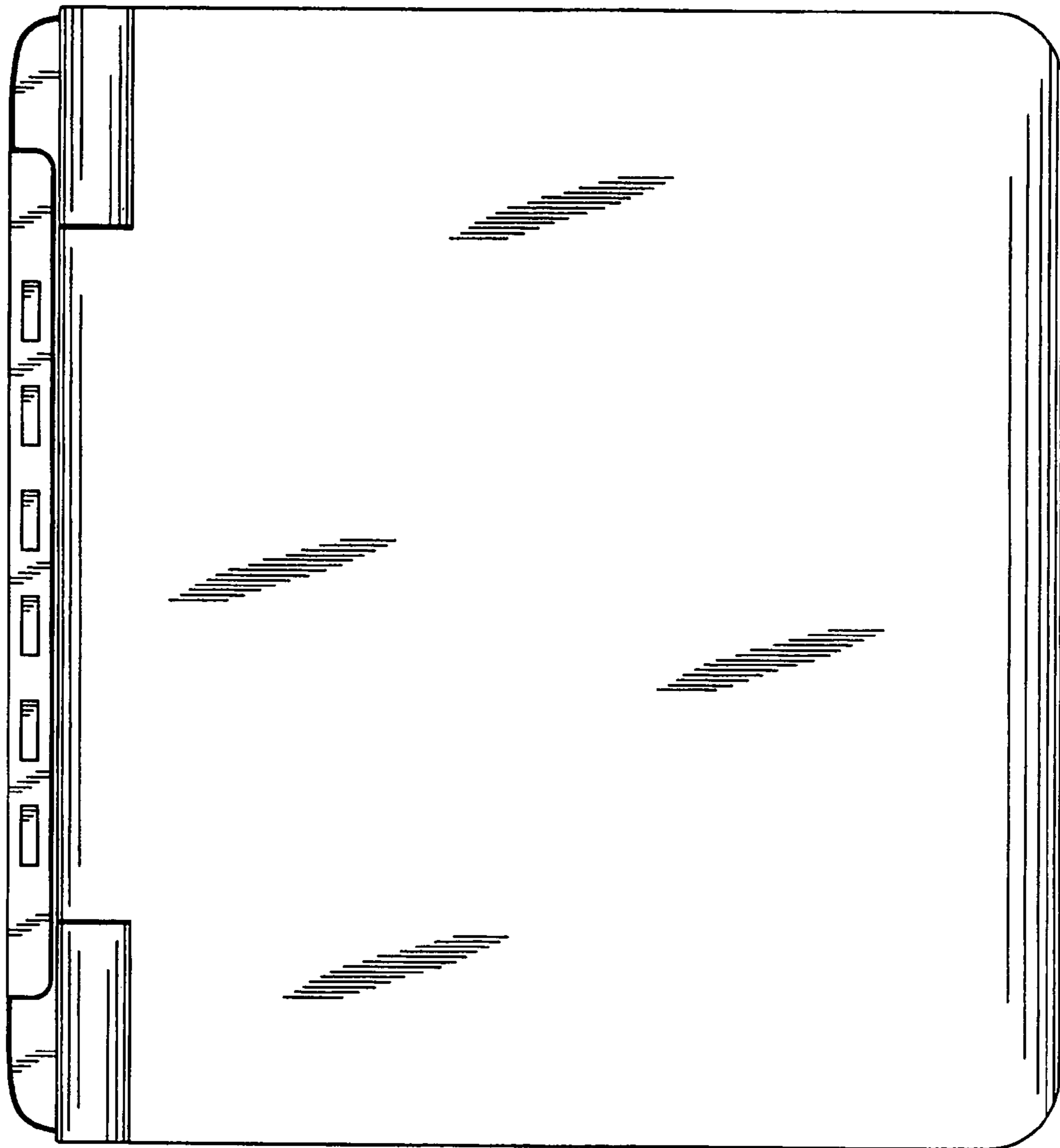


**FIG. 10**

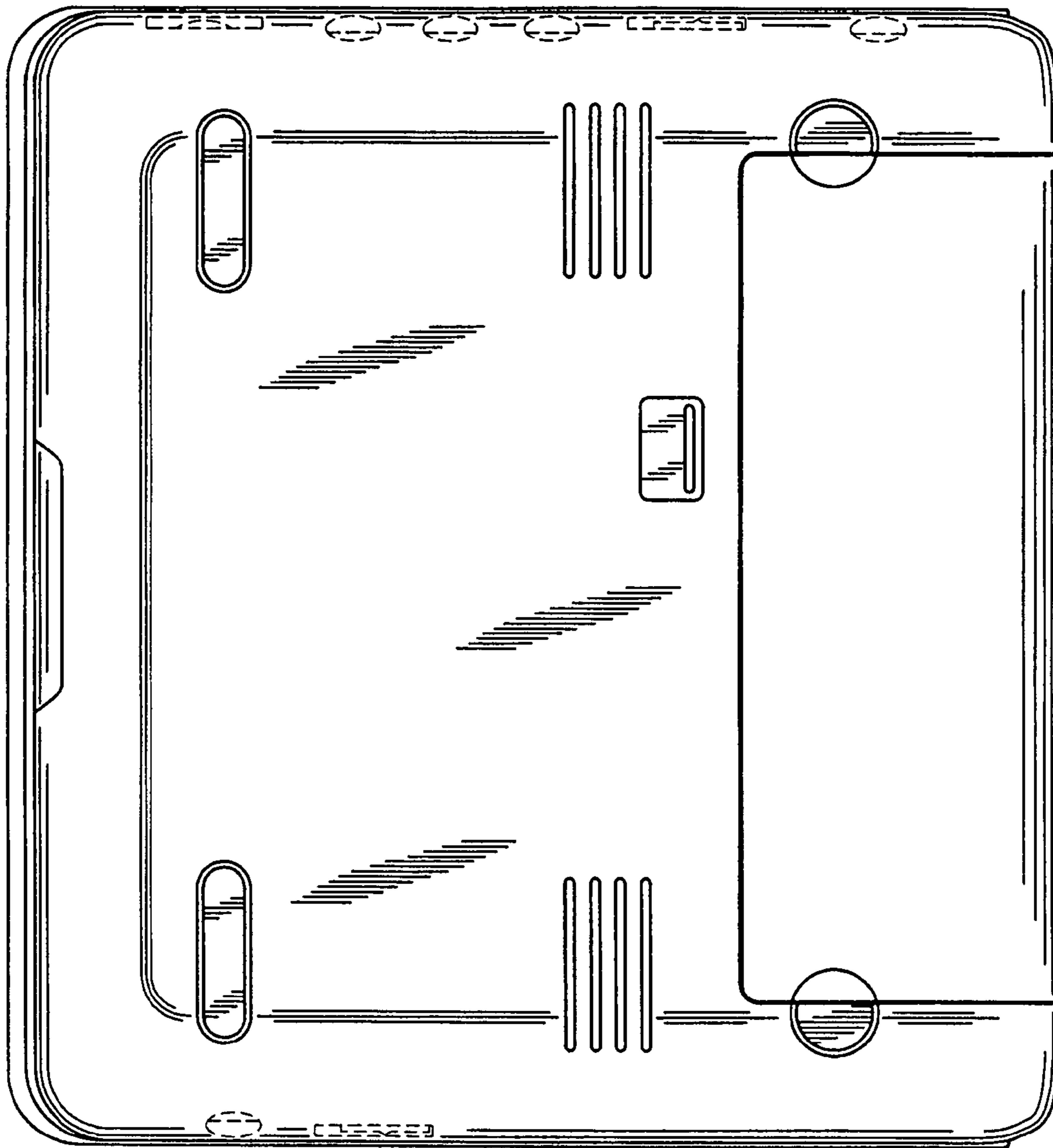




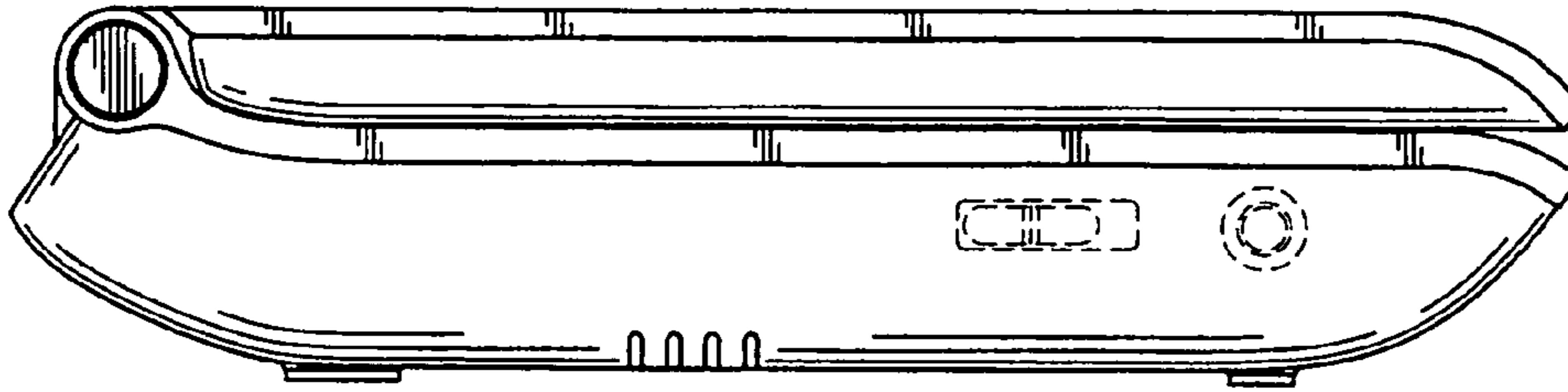
*FIG. 11*



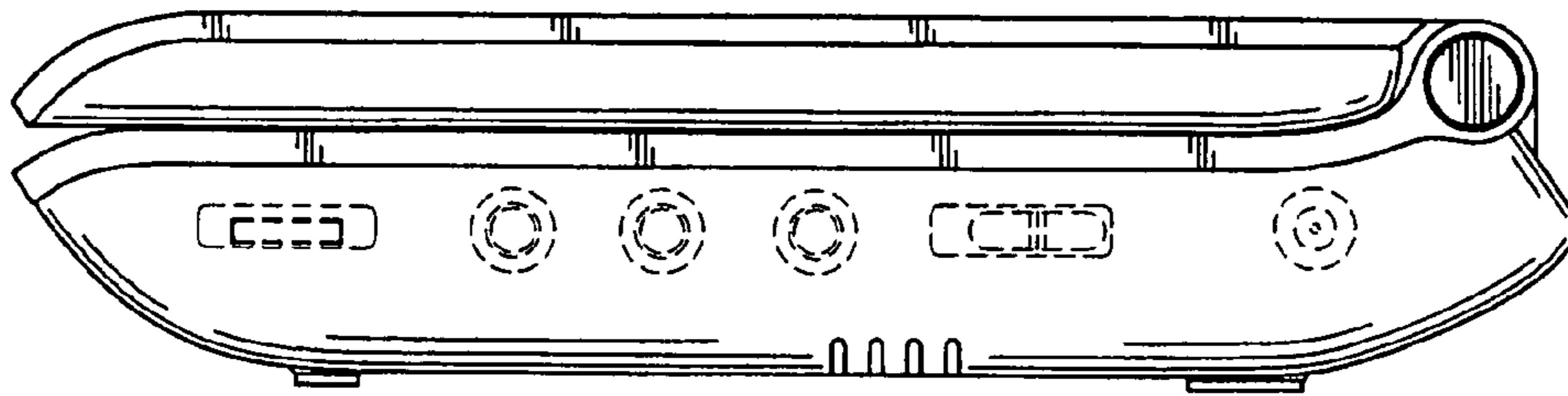
*FIG. 12*



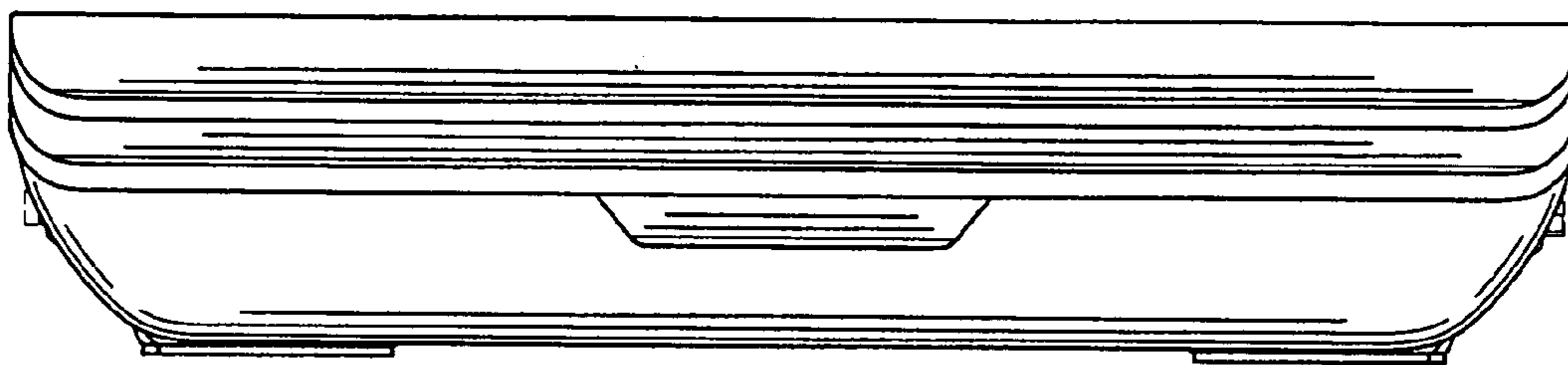
*FIG. 13*



*FIG. 14*



*FIG. 15*



*FIG. 16*

