



US00D568266S

(12) **United States Design Patent**
Shimamoto

(10) **Patent No.:** **US D568,266 S**
(45) **Date of Patent:** **** May 6, 2008**

(54) **TELEVISION SET**
(75) Inventor: **Yasutaka Shimamoto**, Utsunomiya (JP)
(73) Assignee: **Sharp Kabushiki Kaisha**, Osaka (JP)
(**) Term: **14 Years**
(21) Appl. No.: **29/272,940**
(22) Filed: **Feb. 22, 2007**
(30) **Foreign Application Priority Data**
Aug. 23, 2006 (JP) 2006-022232

D453,747 S 2/2002 Kita
D453,748 S 2/2002 Kita
D456,370 S 4/2002 Kita
D458,910 S 6/2002 Kita
D487,731 S * 3/2004 Takami et al. D14/126
D488,784 S * 4/2004 Takami et al. D14/126
D492,269 S 6/2004 Kita
D494,941 S * 8/2004 Kim D14/126
D496,915 S 10/2004 Kita
D497,351 S 10/2004 Kita
D497,599 S 10/2004 Kita
D499,076 S 11/2004 Kita
D501,186 S 1/2005 Kita

(51) **LOC (8) Cl.** **14-03**
(52) **U.S. Cl.** **D14/126**
(58) **Field of Classification Search** D14/125-134,
D14/239, 371, 136, 374-377; 312/7.2; 348/836,
348/838, 180, 184, 325, 739; 341/12; 248/917-924,
248/465, 123.11; 345/104, 133, 156, 168,
345/87, 173, 169; 349/1, 2, 11, 62; 720/605,
720/669, 600, 655, 99, 197; 455/344-347;
369/99, 197
See application file for complete search history.

(Continued)

OTHER PUBLICATIONS

Totsuka, entitled, "Television Set," U.S. Appl. No. 29/245,754, filed Dec. 29, 2005, pending.

(Continued)

Primary Examiner—Raphael Barkai
Assistant Examiner—Randall H Gholson
(74) *Attorney, Agent, or Firm*—Nixon & Vanderhye, PC

(56) **References Cited**
U.S. PATENT DOCUMENTS

D337,113 S 7/1993 Saito
D342,497 S 12/1993 Saito et al.
D342,501 S 12/1993 Saeki et al.
D351,155 S 10/1994 Usami et al.
D351,156 S 10/1994 Usami et al.
D357,244 S 4/1995 Usami et al.
D357,245 S 4/1995 Usami et al.
D357,472 S 4/1995 Usami et al.
D369,596 S 5/1996 Akiyama et al.
D372,026 S 7/1996 Akiyama et al.
D373,583 S 9/1996 Akiyama et al.
D427,169 S 6/2000 Saeki et al.
D429,227 S 8/2000 Shimizu
D431,537 S 10/2000 Saeki et al.
D438,848 S 3/2001 Kita
D439,224 S 3/2001 Kita
D439,225 S 3/2001 Kita

(57) **CLAIM**

The ornamental design for an television set, as shown and described.

DESCRIPTION

FIG. 1 is a perspective view of a television set in accordance with my new design;
FIG. 2 is a front elevation view thereof;
FIG. 3 is a rear elevation view thereof;
FIG. 4 is a top plan view thereof;
FIG. 5 is a bottom plan view thereof; and,
FIG. 6 is a right side elevational view thereof, the left side elevational view being a mirror image thereof.

1 Claim, 5 Drawing Sheets

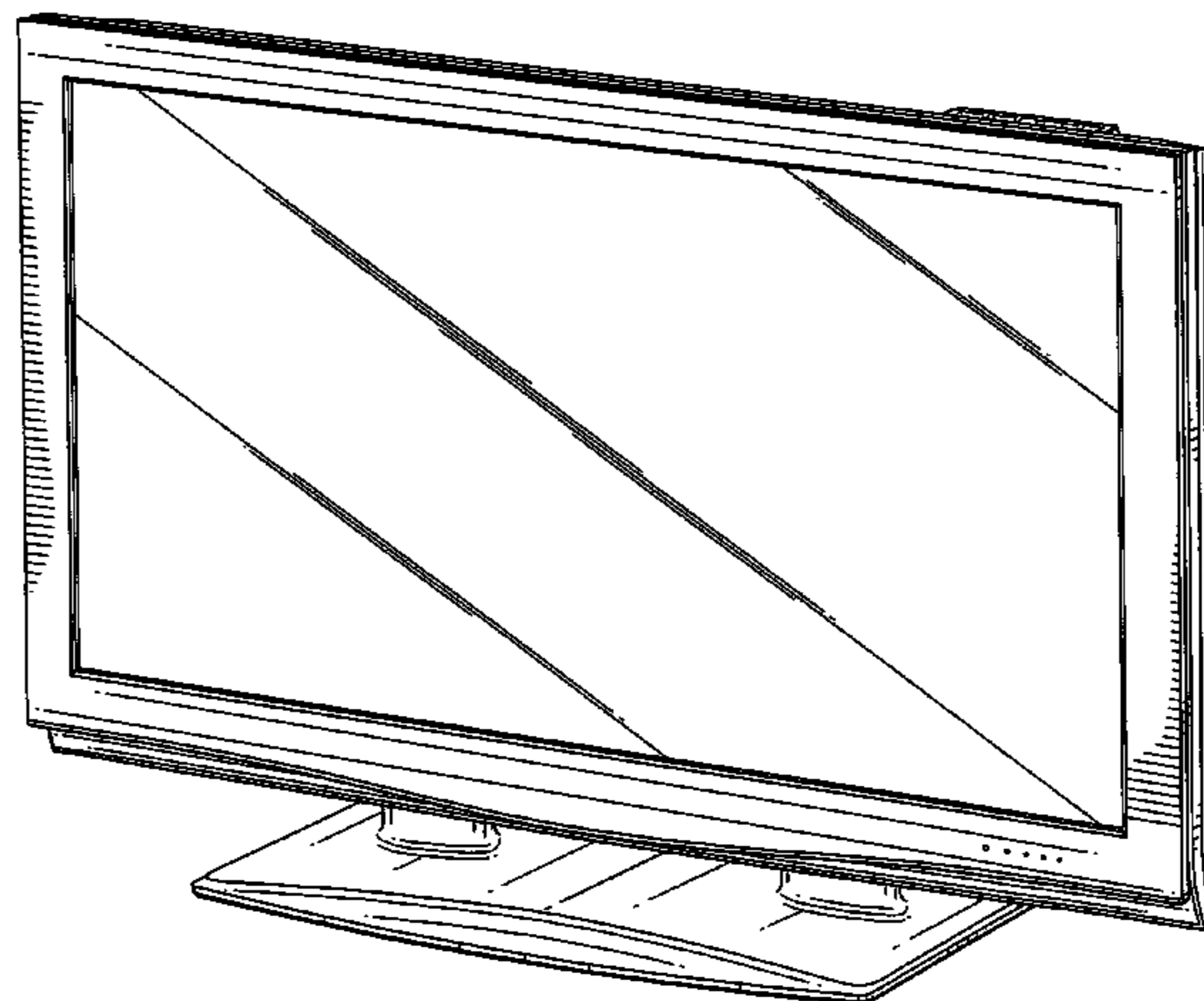

U.S. PATENT DOCUMENTS

D501,654 S	2/2005	Kita	
D502,451 S	3/2005	Kita	
D502,931 S	3/2005	Kita	
D505,123 S	5/2005	Wang	
D510,731 S	10/2005	Kita	
D512,385 S	12/2005	Kita	
D512,386 S	12/2005	Kita	
D512,387 S	12/2005	Kita	
D536,678 S	2/2007	Kita	
D538,242 S	3/2007	Kita	
D538,762 S	3/2007	Fuji et al.	
D538,763 S	3/2007	Fuji et al.	
D539,766 S	4/2007	Kita	
D540,281 S	4/2007	Kita	
D540,282 S	4/2007	Kita	
D540,284 S	4/2007	Kita	
D540,285 S	4/2007	Kita	
D541,240 S	4/2007	Kita	
D541,772 S	5/2007	Kita	
D541,774 S	5/2007	Kita	
D541,775 S	5/2007	Kita	
D543,519 S	5/2007	Kita	
D546,788 S	* 7/2007	Isshiki	D14/126
D553,587 S	* 10/2007	Kim et al.	D14/126

OTHER PUBLICATIONS

Kita, entitled, "Television Set," U.S. Appl. No. 29/243,348, filed Nov. 23, 2005, pending.
 Kita, entitled, "Television Set," U.S. Appl. No. 29/243,704, filed Nov. 30, 2005, pending.
 Kita, entitled, "Television Set," U.S. Appl. No. 29/243,707, filed Nov. 30, 2005, pending.
 Kita, entitled, "Externally Exposed Surfaces of a Speaker for a Television Set," U.S. Appl. No. 29/243,705, filed Nov. 30, 2005, pending.
 Kita, entitled, "Television Set," U.S. Appl. No. 29/261,811, filed Jun. 21, 2006, pending.
 Kita, entitled, "Television Set," U.S. Appl. No. 29/261,807, filed Jun. 21, 2006, pending.
 Kita, entitled, "Television Set," U.S. Appl. No. 29/261,813, filed Jun. 21, 2006, pending.
 Kita, entitled, "Television Set," U.S. Appl. No. 29/260,910, filed Jun. 21, 2006, pending.
 Kita, entitled, "Television Set," U.S. Appl. No. 29/261,815, filed Jun. 21, 2006, pending.

Kita, entitled, "Television Set," U.S. Appl. No. 29/261,810, filed Jun. 21, 2006, pending.
 Kita, entitled, "Television Set," U.S. Appl. No. 29/261,805, filed Jun. 21, 2006, pending.
 Kita, entitled, "Television Set," U.S. Appl. No. 29/261,804, filed Jun. 21, 2006, pending.
 Kita, entitled, "Television Set," U.S. Appl. No. 29/261,803, filed Jun. 21, 2006, pending.
 Kita, entitled, "Television Set," U.S. Appl. No. 29/261,801, filed Jun. 21, 2006, pending.
 Jinuma et al., entitled, "Television Set," U.S. Appl. No. 29/261,809, filed Jun. 21, 2006, pending.
 Inuma et al., entitled, "Television Set," U.S. Appl. No. 29/261,806, filed Jun. 21, 2006, pending.
 Fjuii et al., entitled, "Television Set," U.S. Appl. No. 29/261,811, filed Jun. 21, 2006, pending.
 Fujii et al., entitled, "Television Set," U.S. Appl. No. 29/261,807, filed Jun. 21, 2006, pending.
 Fujii et al., entitled, "Television Set," U.S. Appl. No. 29/261,813, filed Jun. 21, 2006, pending.
 Fujii et al., entitled, "Television Set," U.S. Appl. No. 29/260,910, filed Jun. 21, 2006, pending.
 Fujii et al., entitled, "Television Set," U.S. Appl. No. 29/266,495, filed Sep. 22, 2006, pending.
 Fujii et al., entitled, "Television Set," U.S. Appl. No. 29/261,802, filed Jun. 21, 2006, pending.
 Kita, entitled, "Television Set," U.S. Appl. No. 29/271,041, filed Jan. 9, 2007, pending.
 Kita., entitled, "Television Set," U.S. Appl. No. 29/271,043, filed Jan. 9, 2007, pending.
 Kita., entitled, "Television Set," U.S. Appl. No. 29/271,155, filed Jan. 11, 2007, pending.
 Kita., entitled, "Television Set," U.S. Appl. No. 29/271,156, filed Jan. 11, 2007, pending.
 Kita., entitled, "Television Set," U.S. Appl. No. 29/271,042, filed Jan. 9, 2007, pending.
 Fujii et al., entitled, "Television Set," U.S. Appl. No. 29/272,942, filed Feb. 22, 2007, pending.
 Fujii et al., entitled, "Television set," U.S. Appl. No. 29/272,938, filed Feb. 22, 2007, pending.
 Fujii et al., entitled "Television Set," U.S. Appl. No. 29/272,941, filed Feb. 22, 2007, pending.
 Kita., entitled, "Television Set," U.S. Appl. No. 29/272,939, filed Feb. 22, 2007, pending.

* cited by examiner

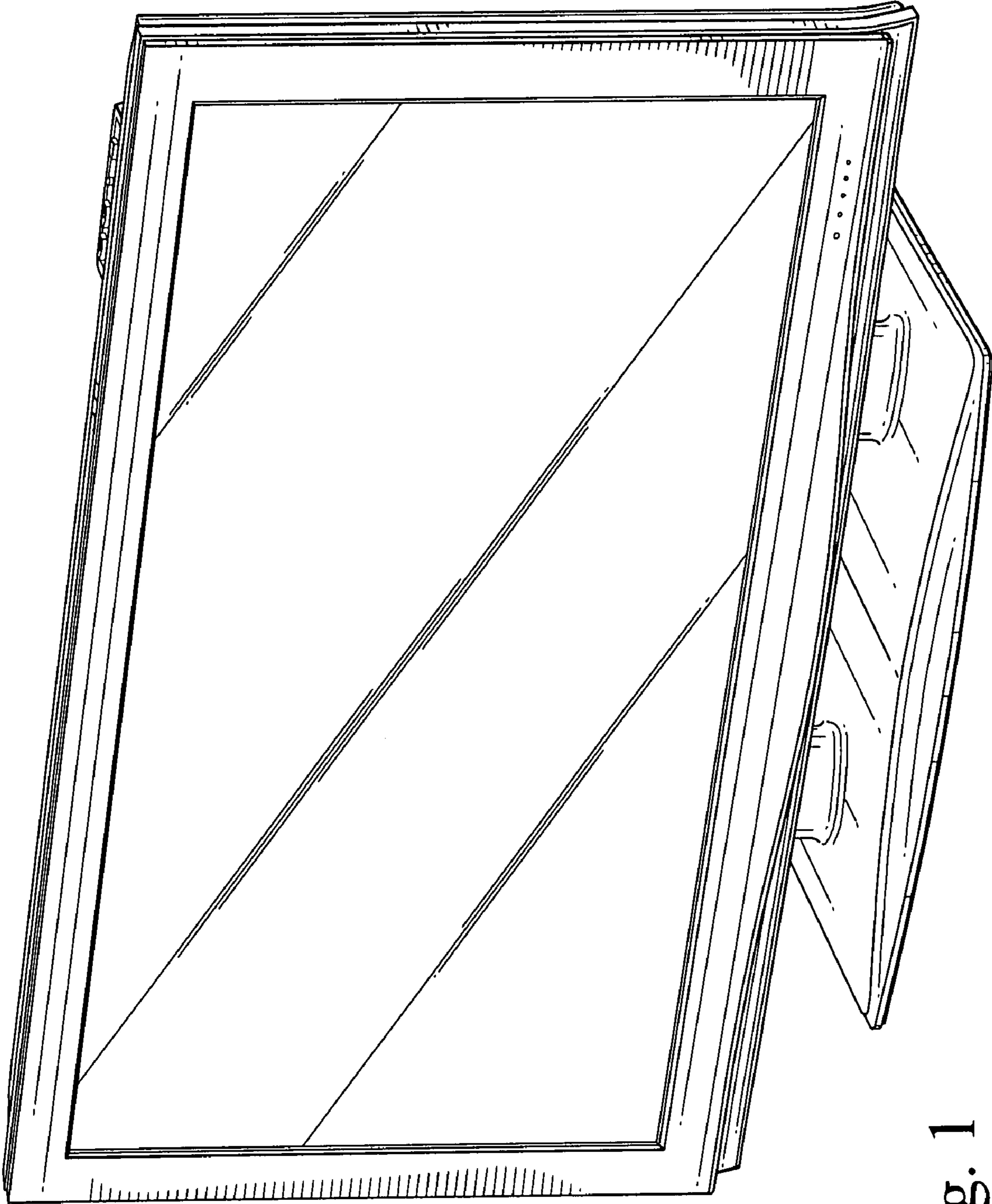

Fig. 1

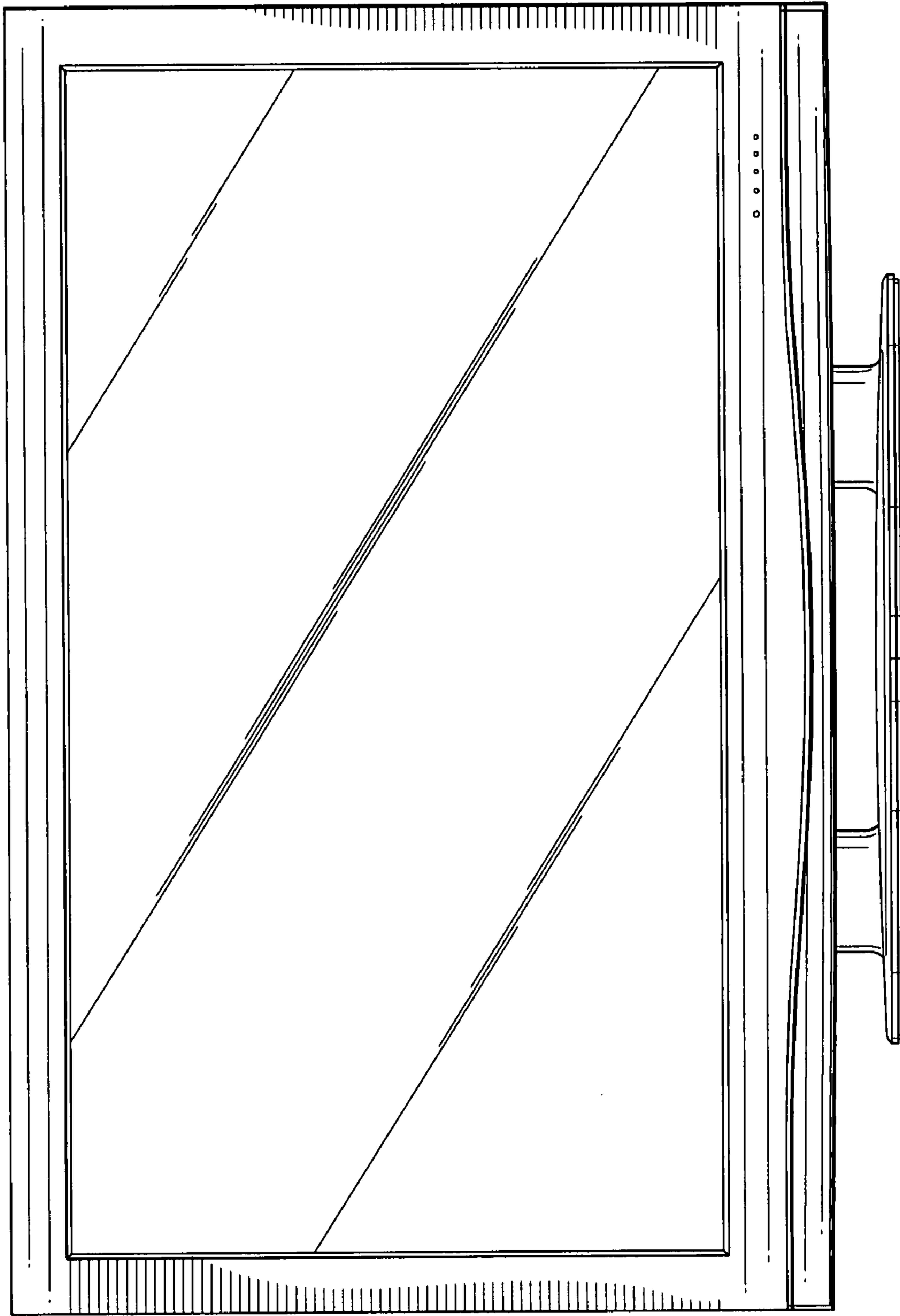

Fig. 2

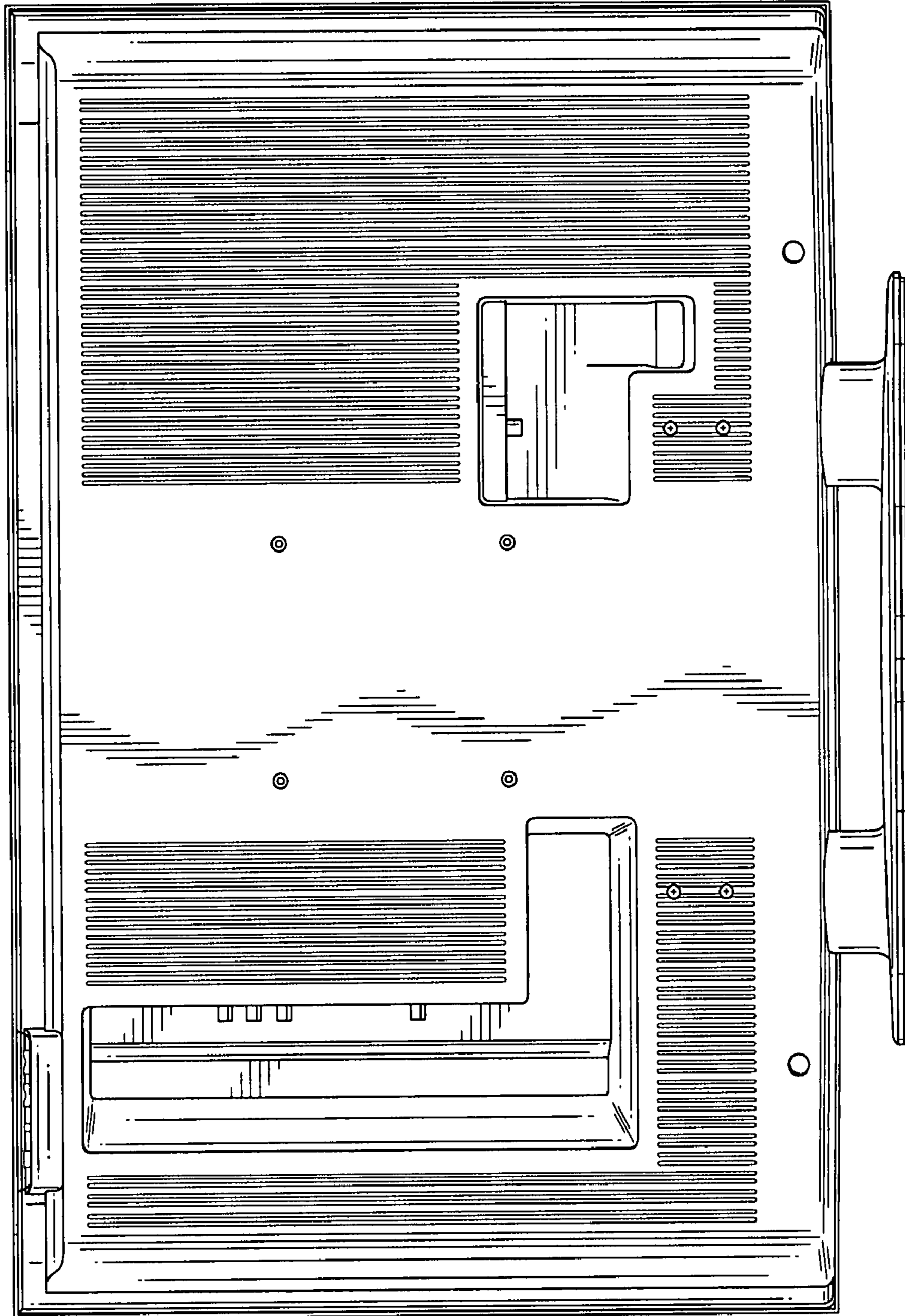

Fig. 3

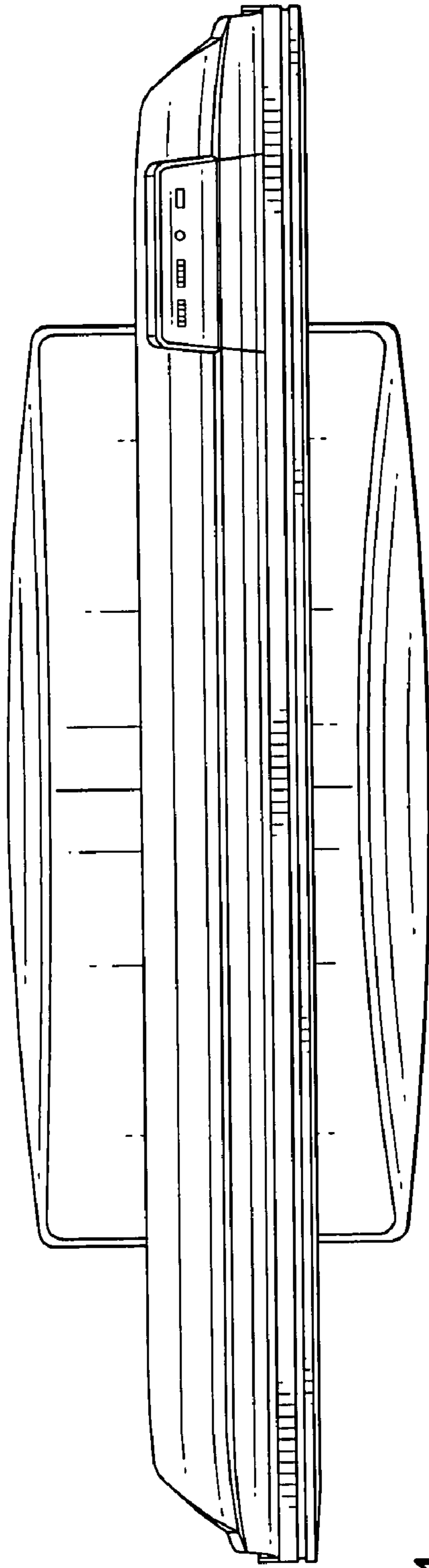

Fig. 4

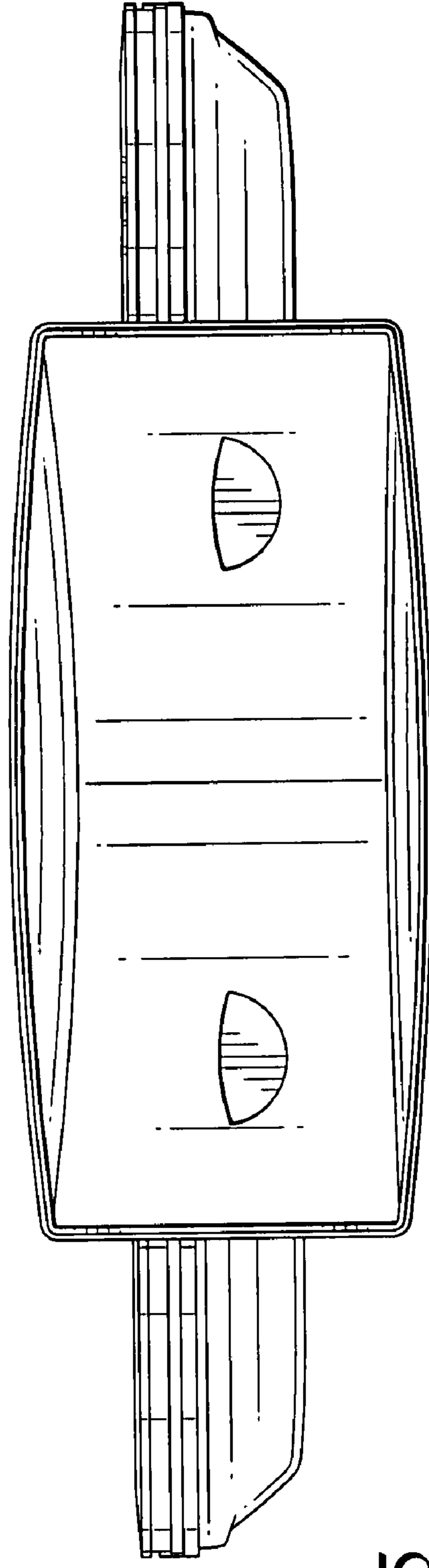

Fig. 5

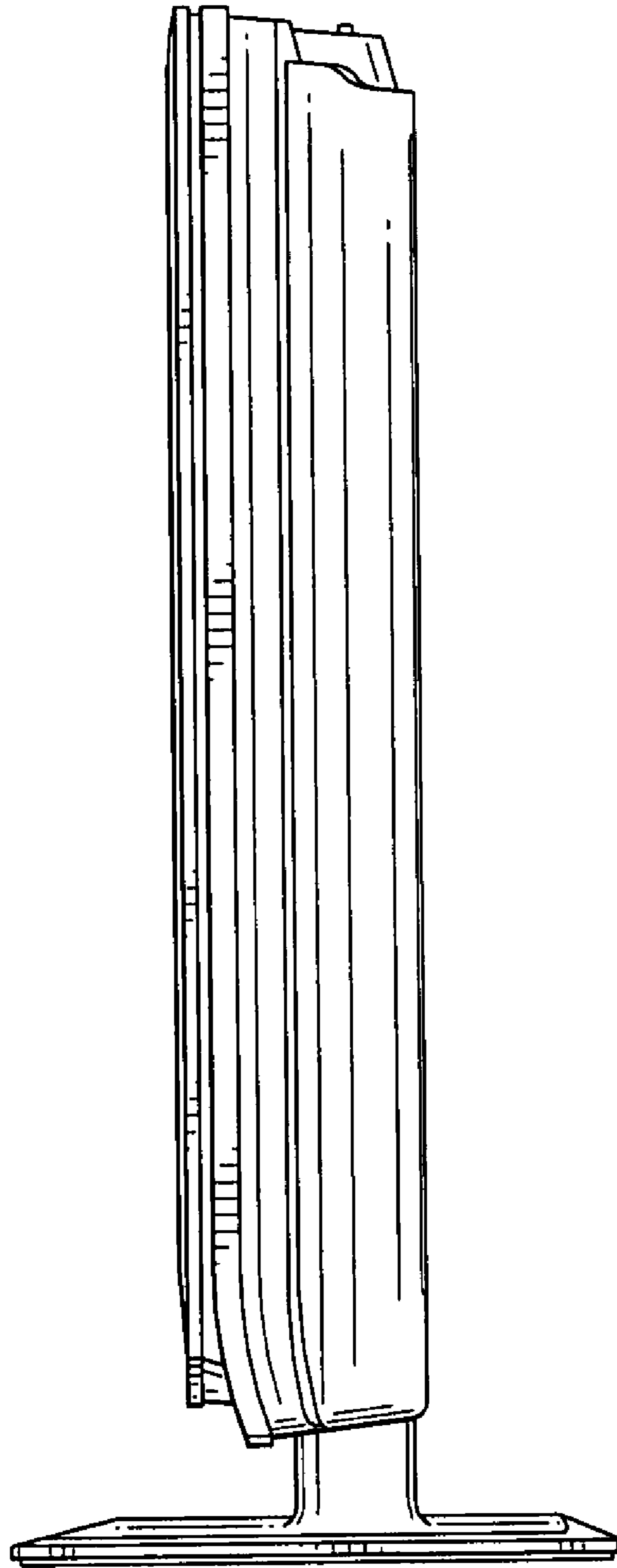

Fig. 6