



US00D568167S

(12) **United States Design Patent** (10) **Patent No.:** **US D568,167 S**
Sasaki et al. (45) **Date of Patent:** **** May 6, 2008**

(54) **BOTTLE** 2007/0045222 A1* 3/2007 Denner et al. 215/382

(75) Inventors: **Masaaki Sasaki**, Koto-ku (JP); **Takao Iizuka**, Koto-ku (JP) * cited by examiner

(73) Assignee: **Yoshino Kogyosho Co., Ltd.**, Tokyo (JP) *Primary Examiner*—Stella M. Reid
Assistant Examiner—Elizabeth J Oswecki
(74) *Attorney, Agent, or Firm*—Oliff & Berridge, PLC

(**) Term: **14 Years**

(57) **CLAIM**

(21) Appl. No.: **29/260,472**

The ornamental design for a bottle, as shown and described.

(22) Filed: **May 26, 2006**

DESCRIPTION

(30) **Foreign Application Priority Data**

Nov. 28, 2005 (JP) 2005-034901

FIG. 1 is a perspective view of a bottle showing our new design;

(51) **LOC (8) Cl.** **09-01**

FIG. 2 is a front elevation view thereof. A rear elevation view is identical with the front elevation view.

(52) **U.S. Cl.** **D9/560; D9/570**

FIG. 3 is a right side elevation view thereof. A left side elevation view is identical with the right side elevation view.

(58) **Field of Classification Search** D9/501, D9/516, 520, 530, 537, 538, 539, 540, 541, D9/542, 547, 548, 550, 551, 552, 553, 559, D9/560, 563, 564, 565, 566, 567, 569, 570, D9/571, 574, 575; 206/527; 215/381–385, 215/40, 396, 398

FIG. 4 is a top plan view thereof.

See application file for complete search history.

FIG. 5 is a cross-sectional view thereof taken vertically along the line 5—5 of FIG. 3.

(56) **References Cited**

U.S. PATENT DOCUMENTS

- D398,539 S * 9/1998 Guislain D9/564
- D451,032 S * 11/2001 Iizuka et al. D9/569
- D459,234 S * 6/2002 Bourque et al. D9/543
- 7,004,342 B2 * 2/2006 Bourque et al. 215/384
- D525,527 S * 7/2006 Ogg D9/516
- D525,528 S * 7/2006 Lane et al. D9/516
- D528,427 S * 9/2006 Sasaki et al. D9/541
- D533,071 S * 12/2006 Forget D9/564
- D533,782 S * 12/2006 Ogg et al. D9/516
- 2007/0039918 A1 * 2/2007 Lane et al. 215/381

FIG. 6 is a cross-sectional view thereof taken vertically along the line 6—6 of FIG. 2.

FIG. 7 is an enlarged cross sectional view thereof taken along line 7—7 in FIG. 2.

FIG. 8 is an enlarged cross sectional view thereof taken along line 8—8 in FIG. 2.

FIG. 9 is an enlarged cross sectional view thereof taken along line 9—9 in FIG. 2.

FIG. 10 is an enlarged cross sectional view thereof taken along line 10—10 in FIG. 2; and,

FIG. 11 is an enlarged cross sectional view taken along line 11—11 in FIG. 2.

1 Claim, 11 Drawing Sheets

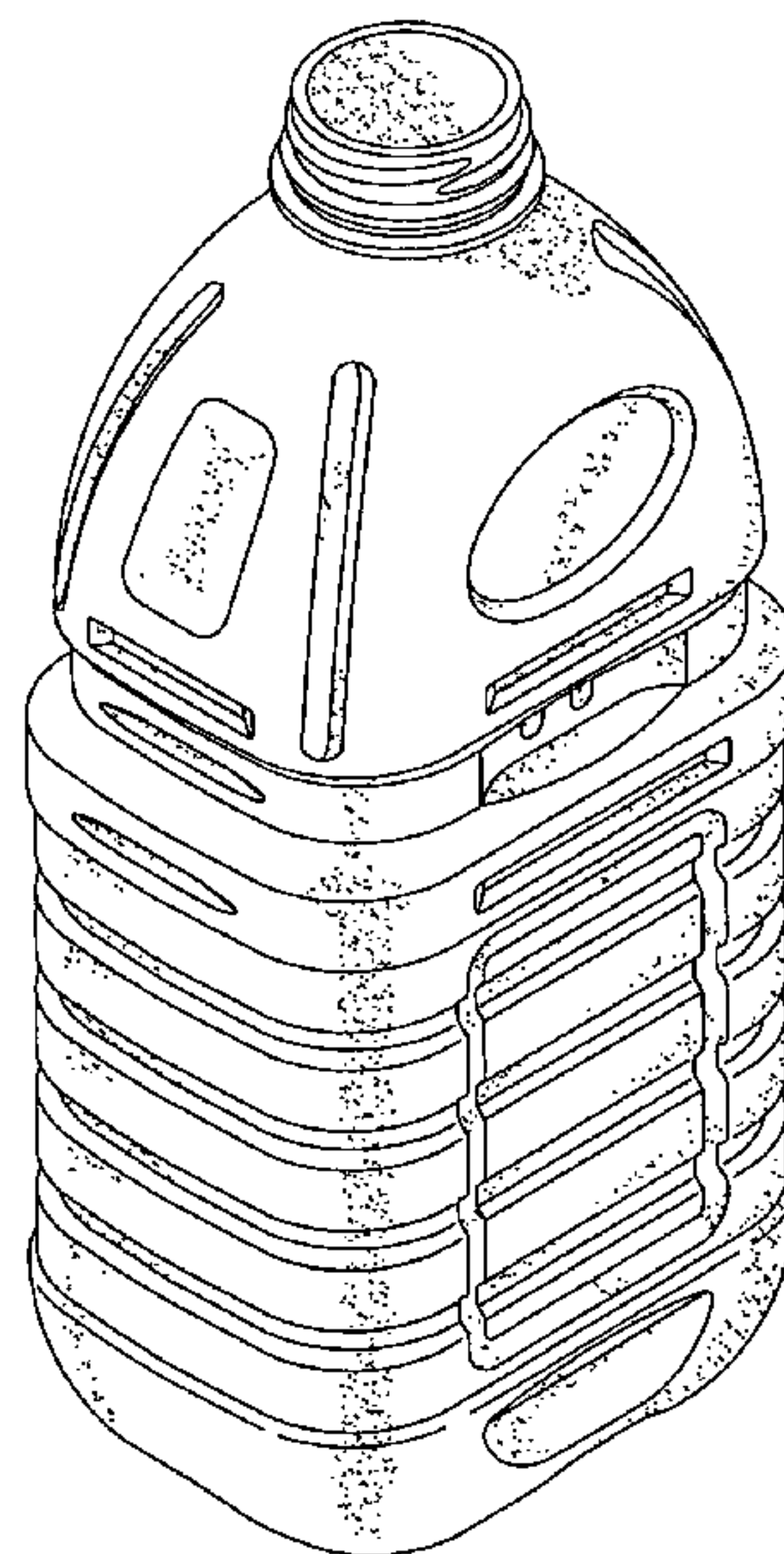

FIG. 1

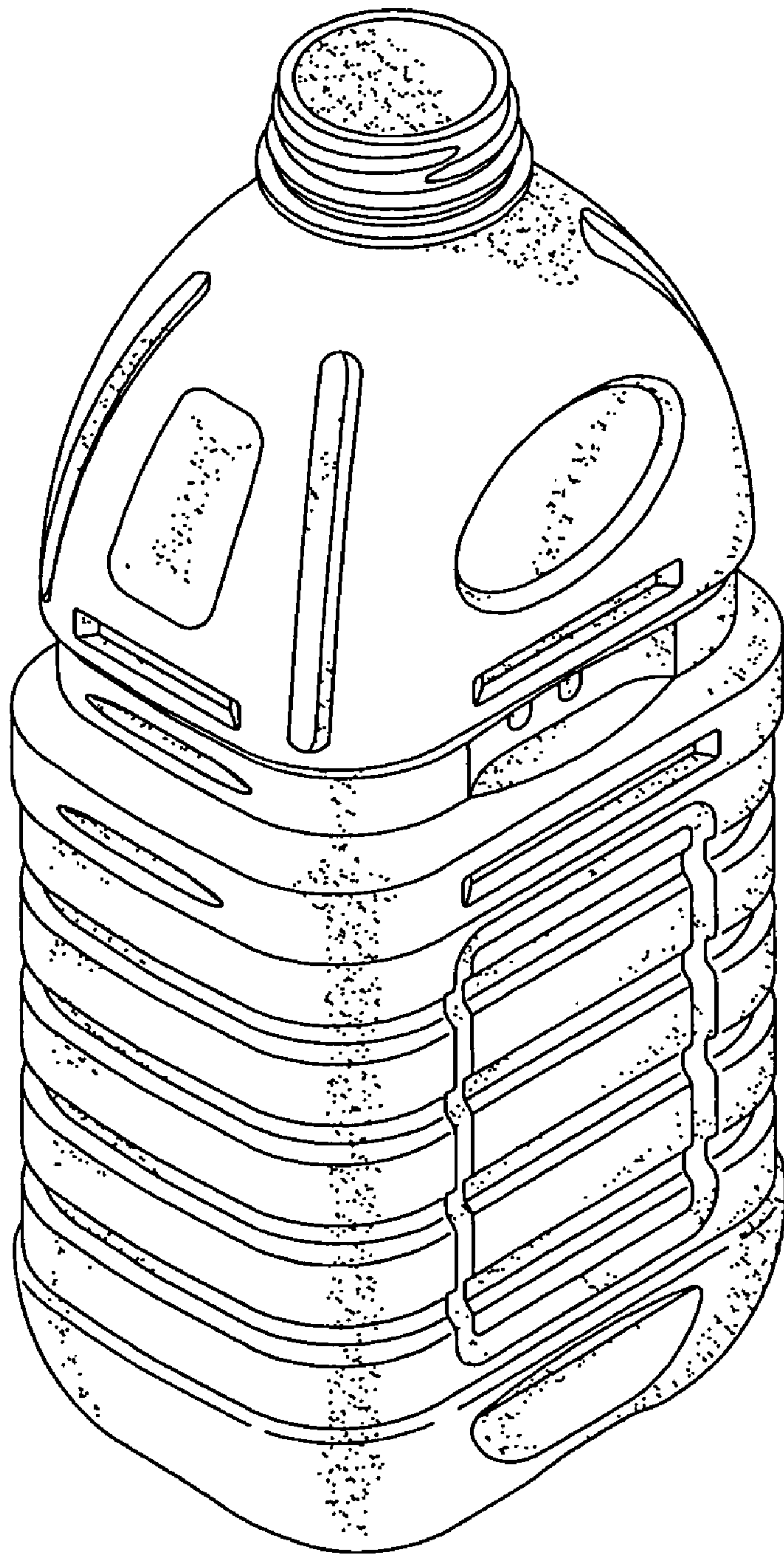

FIG. 2

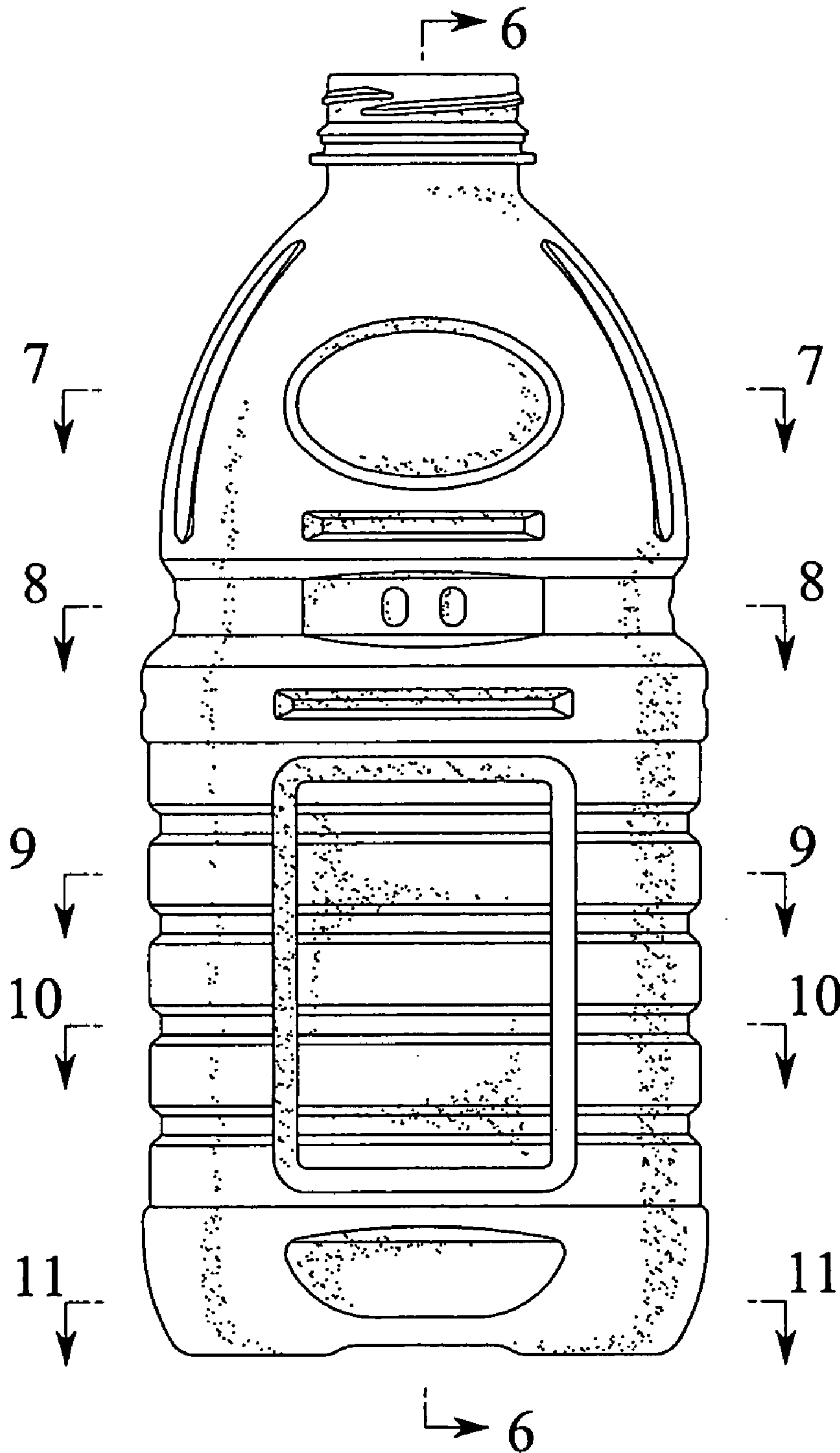

FIG. 3

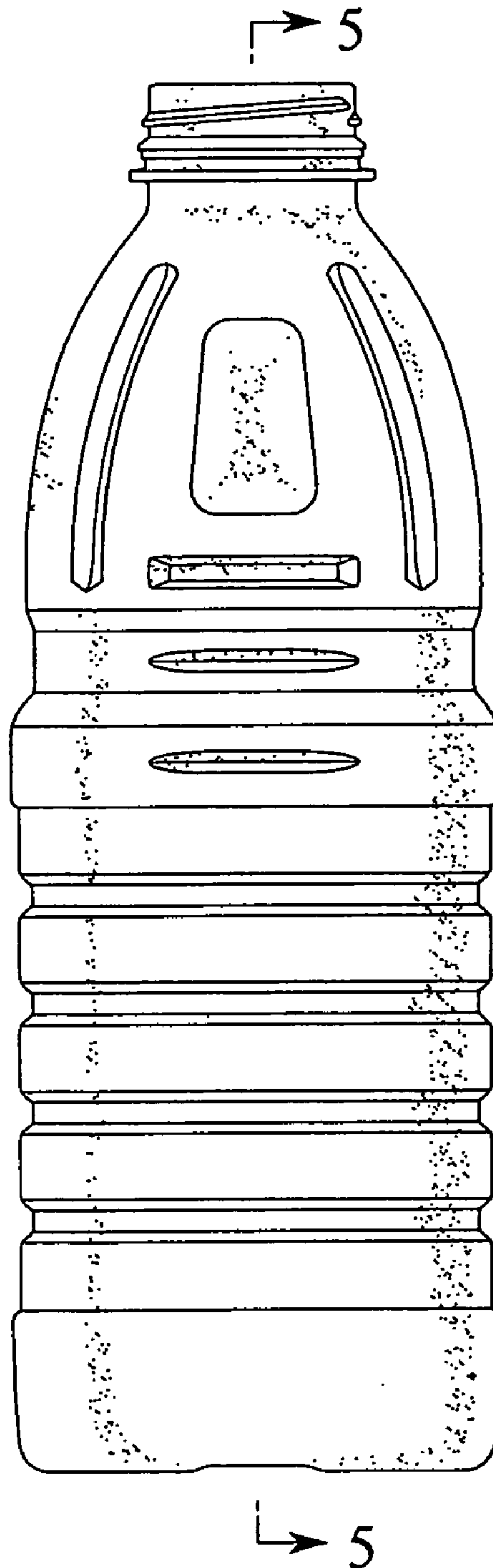

FIG. 4

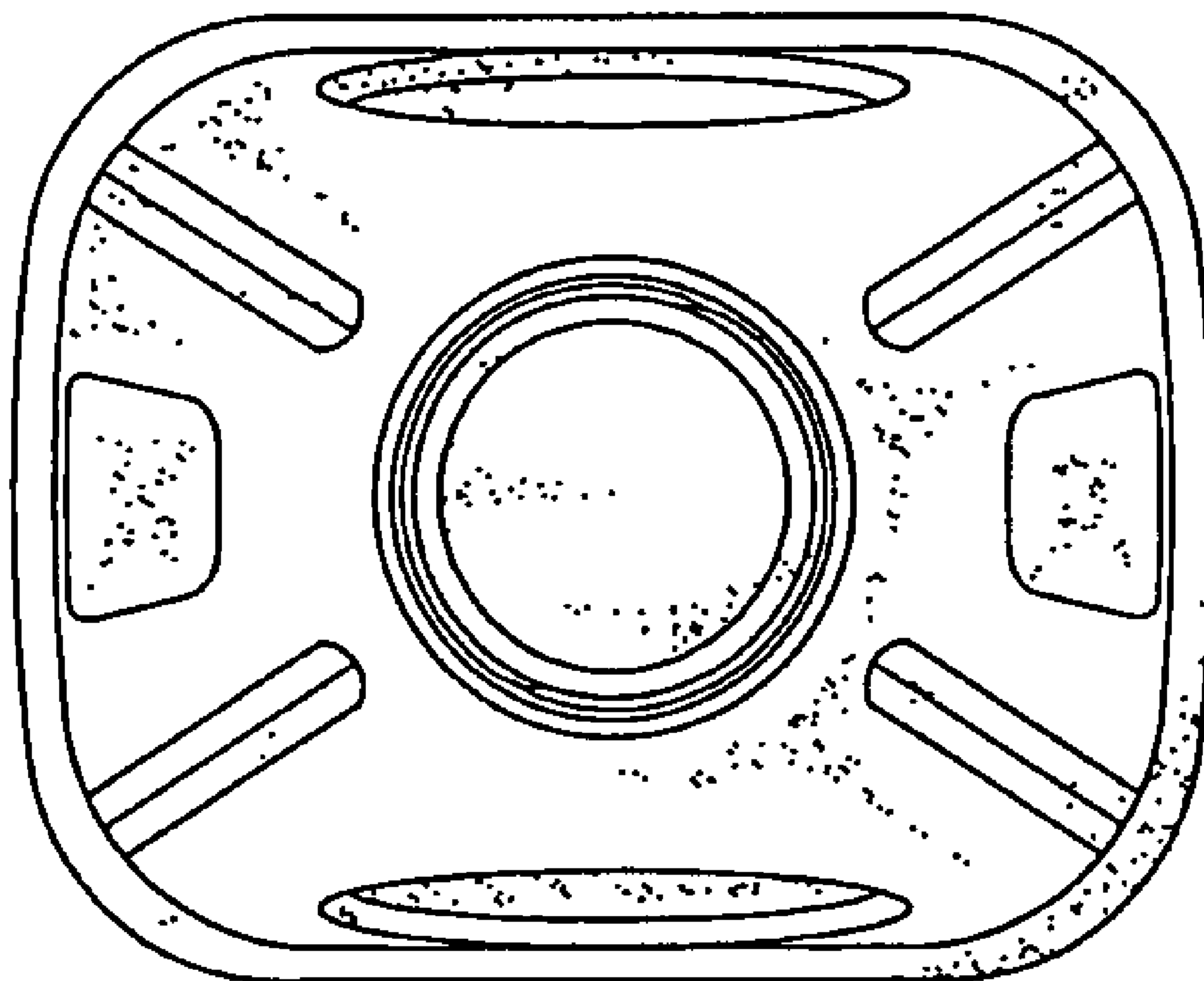

FIG. 5

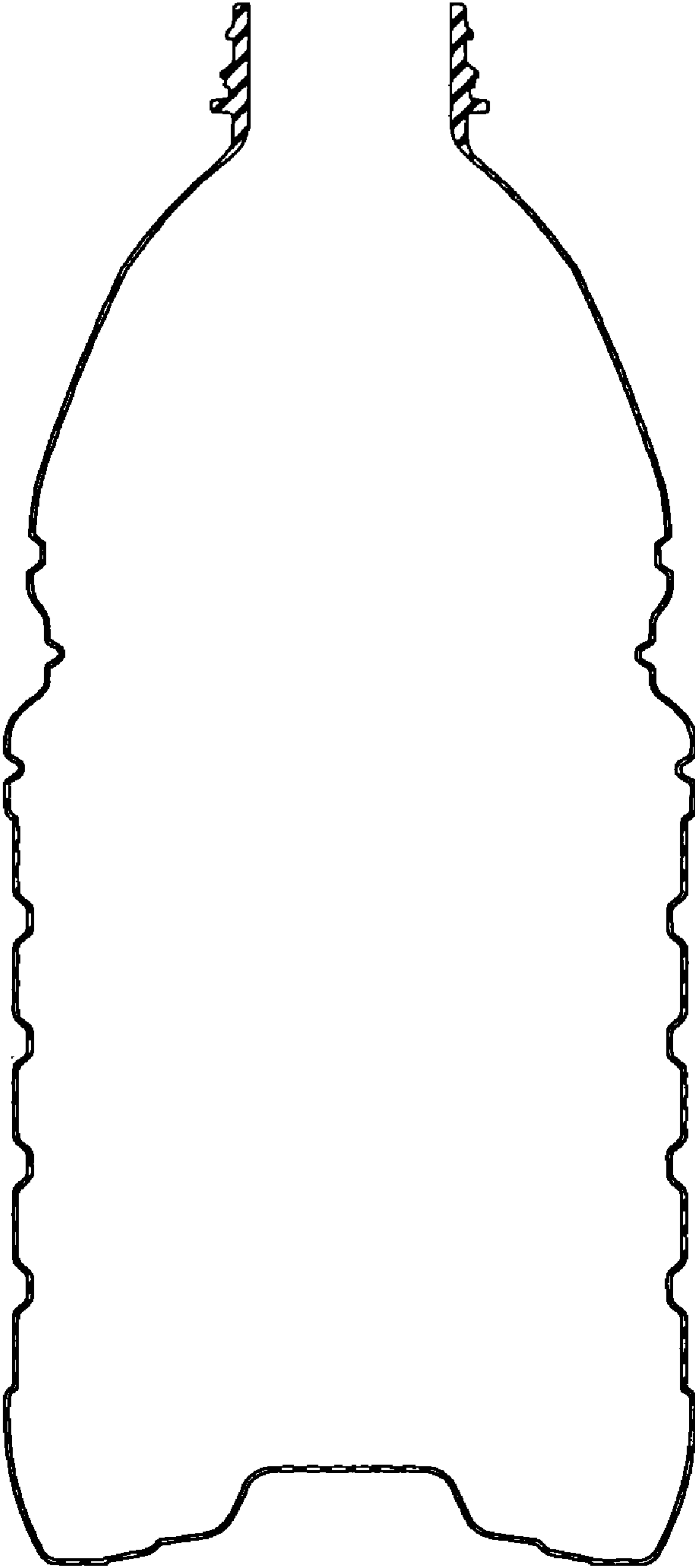

FIG. 6

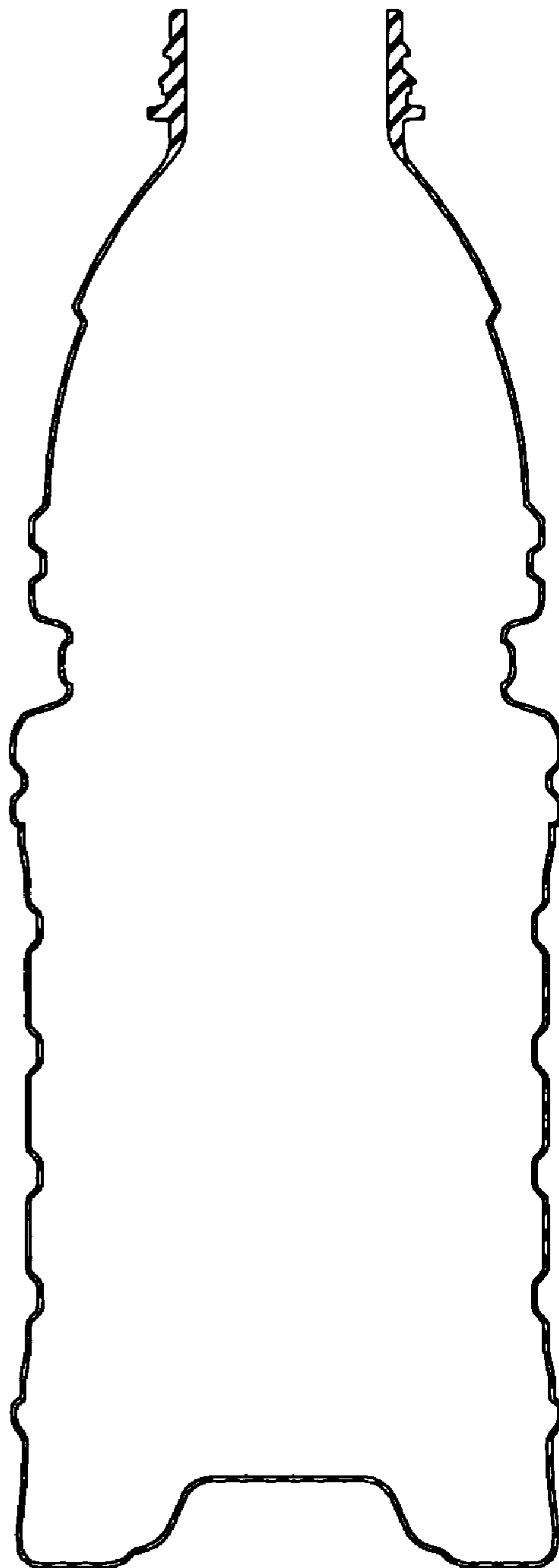

FIG. 7

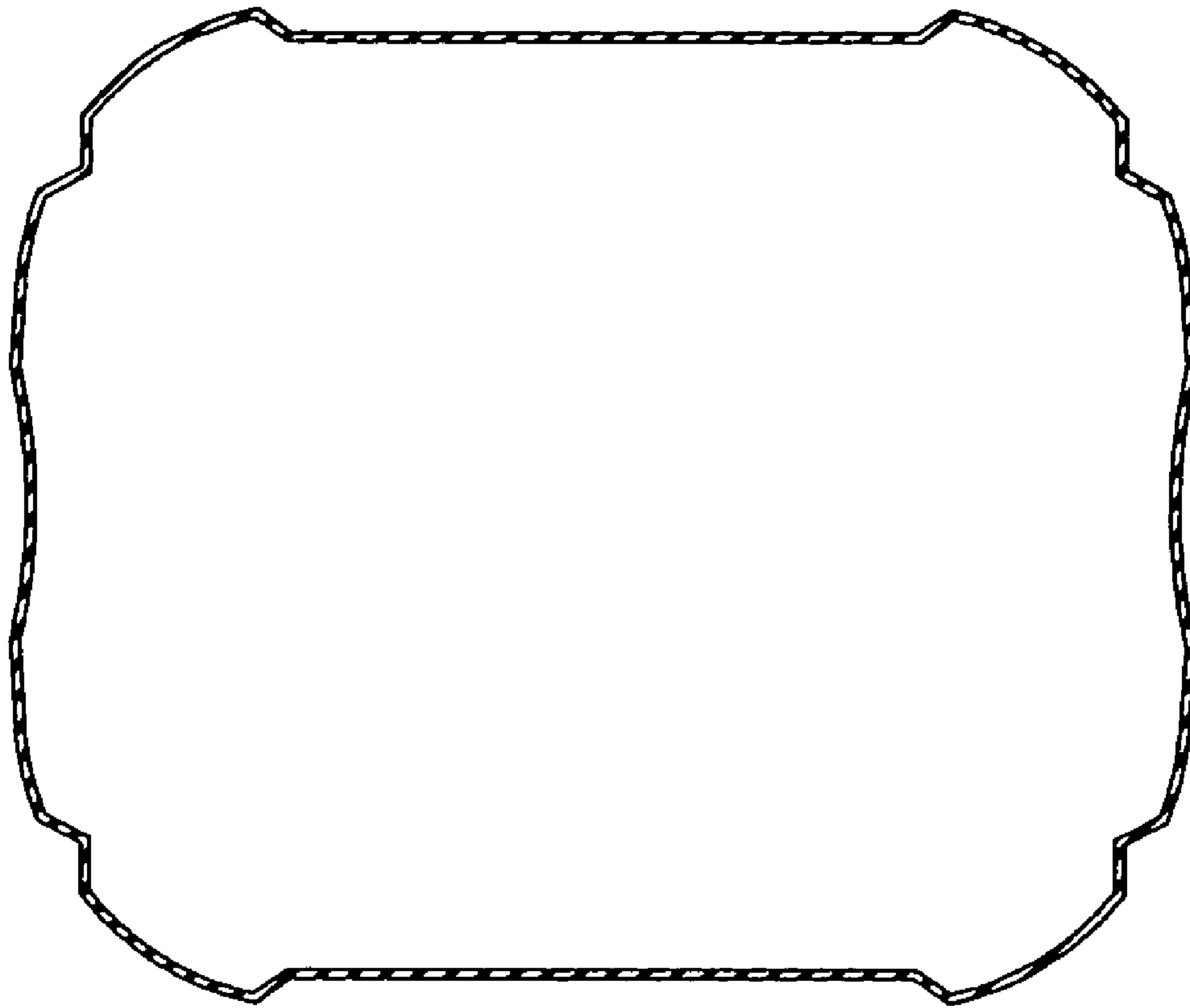

FIG. 8

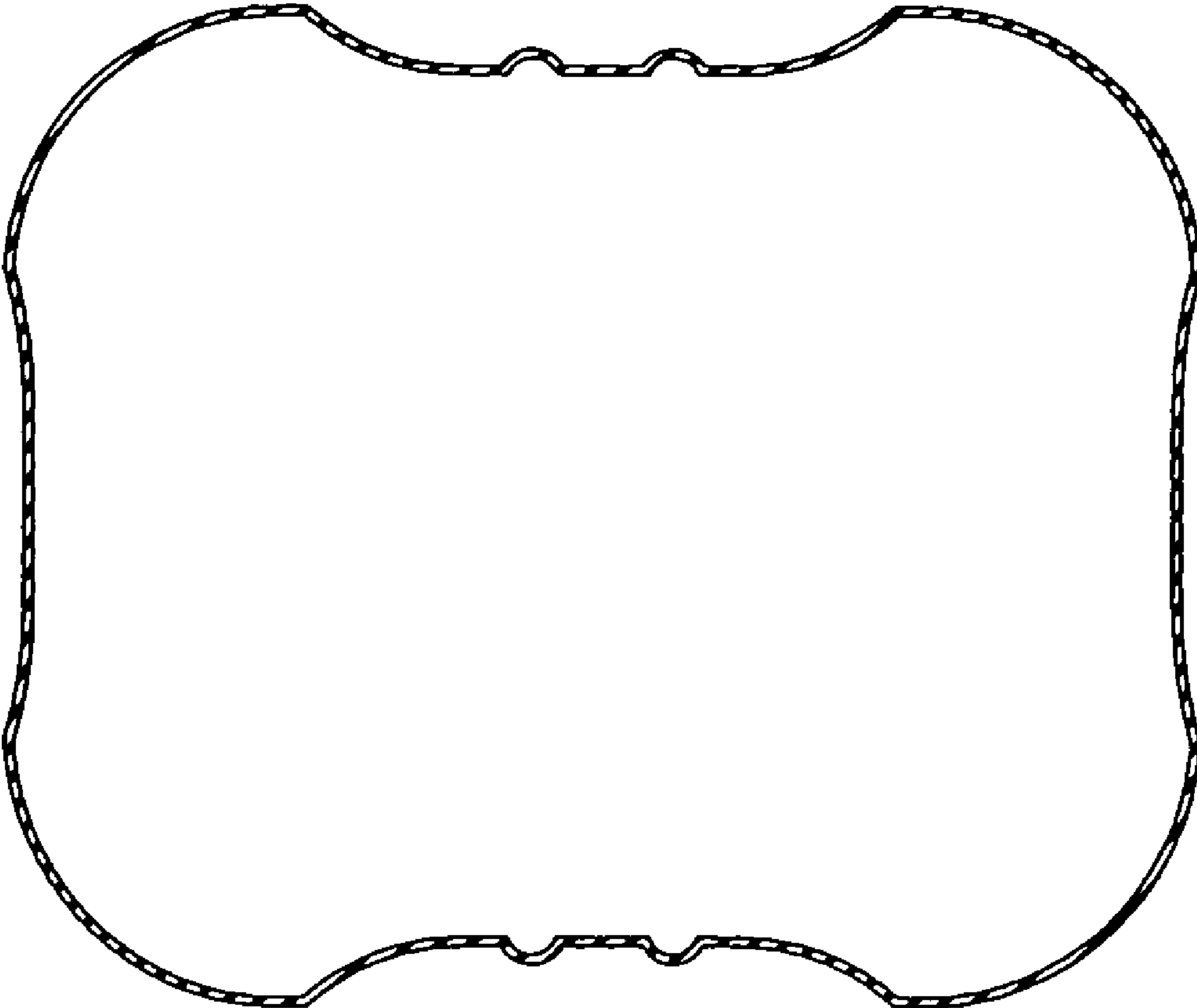

FIG. 9

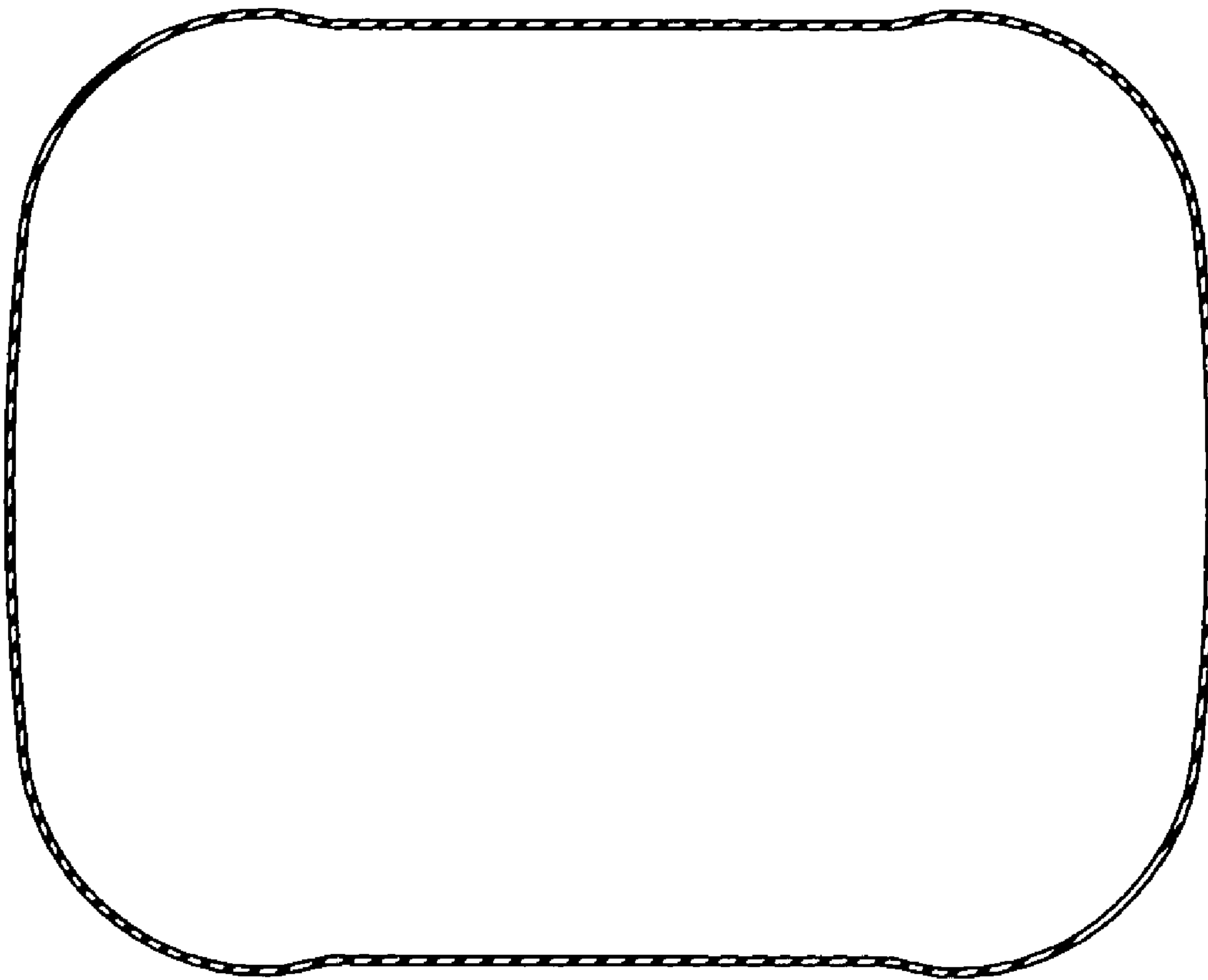

FIG. 10

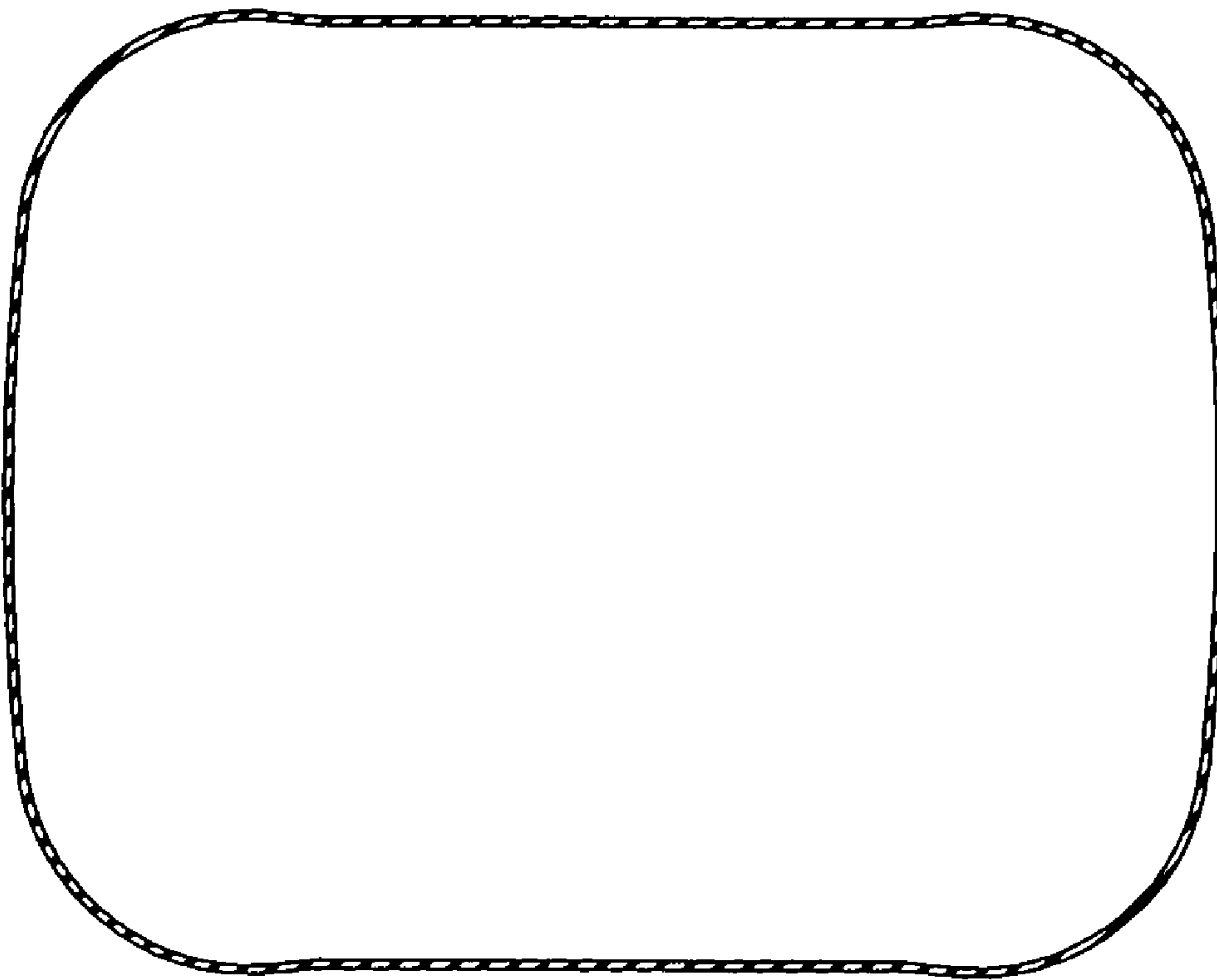

FIG. 11

