



US00D568159S

(12) **United States Design Patent**  
**Dellevigne**

(10) **Patent No.:** **US D568,159 S**

(45) **Date of Patent:** **\*\* May 6, 2008**

(54) **PORTION OF A BOTTLE**

(75) Inventor: **Laura A. Dellevigne**, Danbury, CT  
(US)

(73) Assignee: **PepsiCo, Inc.**, Purchase, NY (US)

(\*\*) Term: **14 Years**

(21) Appl. No.: **29/297,426**

(22) Filed: **Nov. 9, 2007**

**Related U.S. Application Data**

(62) Division of application No. 29/259,428, filed on May 8, 2006, now Pat. No. Des. 559,699.

(51) **LOC (8) Cl.** ..... **09-01**

(52) **U.S. Cl.** ..... **D9/516; D9/552; D9/554;**  
D9/556

(58) **Field of Classification Search** ..... D9/600,  
D9/640, 649, 667-668, 670, 681, 772-776,  
D9/779-780, 516, 520, 537-540, 545-547,  
D9/549, 551-554, 556-558, 564-567, 569-570;  
D7/509-510; 215/382-384, 396, 398, 373,  
215/375

See application file for complete search history.

(56) **References Cited**

**U.S. PATENT DOCUMENTS**

D379,153 S \* 5/1997 Richardson ..... D9/537  
D381,272 S \* 7/1997 Coons ..... D9/540  
D385,796 S \* 11/1997 Richardson ..... D9/537  
D395,604 S \* 6/1998 Lecoule ..... D9/565 X  
5,785,197 A \* 7/1998 Slat ..... 215/375

D398,855 S \* 9/1998 Ito ..... D9/537  
5,906,286 A \* 5/1999 Matsuno et al. .... 215/375  
D423,939 S \* 5/2000 Ogg ..... D9/537  
D424,948 S \* 5/2000 Ullmo ..... D9/540  
D429,166 S \* 8/2000 Ogg ..... D9/552  
D430,036 S \* 8/2000 Steward et al. .... D9/538  
D432,018 S \* 10/2000 Steward ..... D9/537  
D432,020 S \* 10/2000 Steward et al. .... D9/540  
D447,061 S \* 8/2001 Peek ..... D9/549  
D455,964 S \* 4/2002 Patterson ..... D9/552  
D466,023 S \* 11/2002 Eickmeier ..... D9/552  
D517,864 S \* 3/2006 Yu ..... D7/510

\* cited by examiner

*Primary Examiner*—Carol Rademaker

(74) *Attorney, Agent, or Firm*—Banner & Witcoff, Ltd.

(57) **CLAIM**

The ornamental design for a portion of a bottle, as shown and described.

**DESCRIPTION**

FIG. 1 is a top, right, front perspective view of a new design for a portion of a bottle;

FIG. 2 is a rear elevational view thereof;

FIG. 3 is a right side elevational view thereof;

FIG. 4 is a left side elevational view thereof;

FIG. 5 is a top plan view thereof; and,

FIG. 6 is a front elevational view thereof.

The dash lines shown in the drawings are for illustrative purposes only form no part of the claimed design.

**1 Claim, 3 Drawing Sheets**

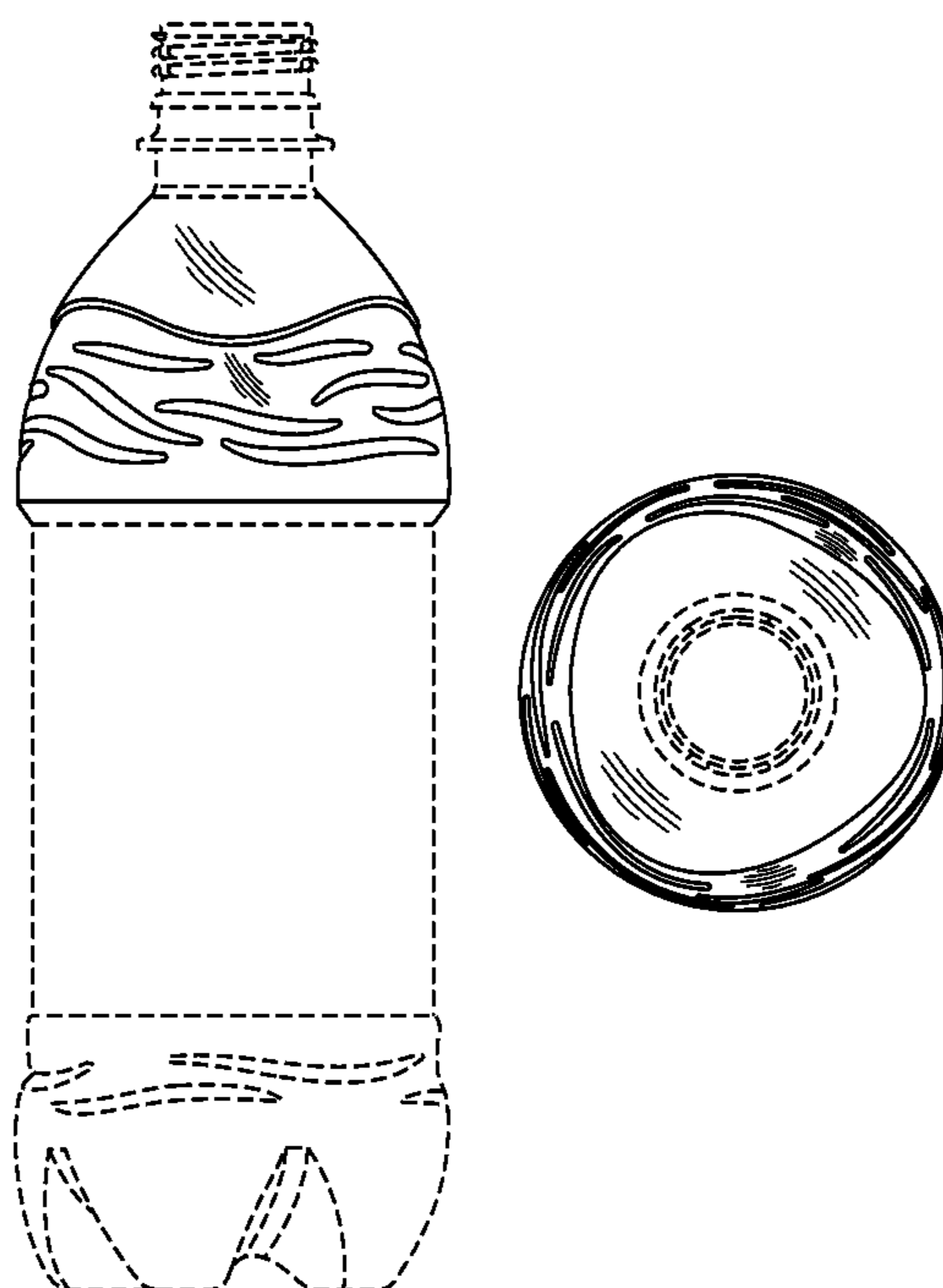

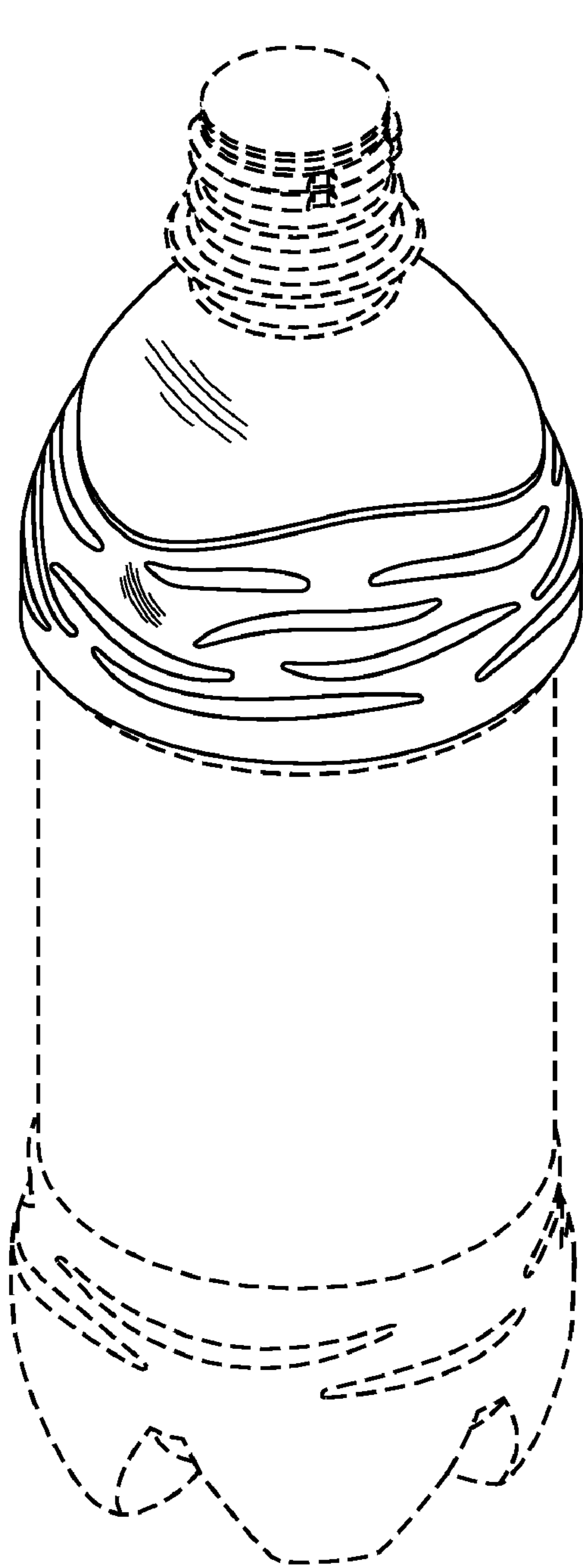

FIG. 1

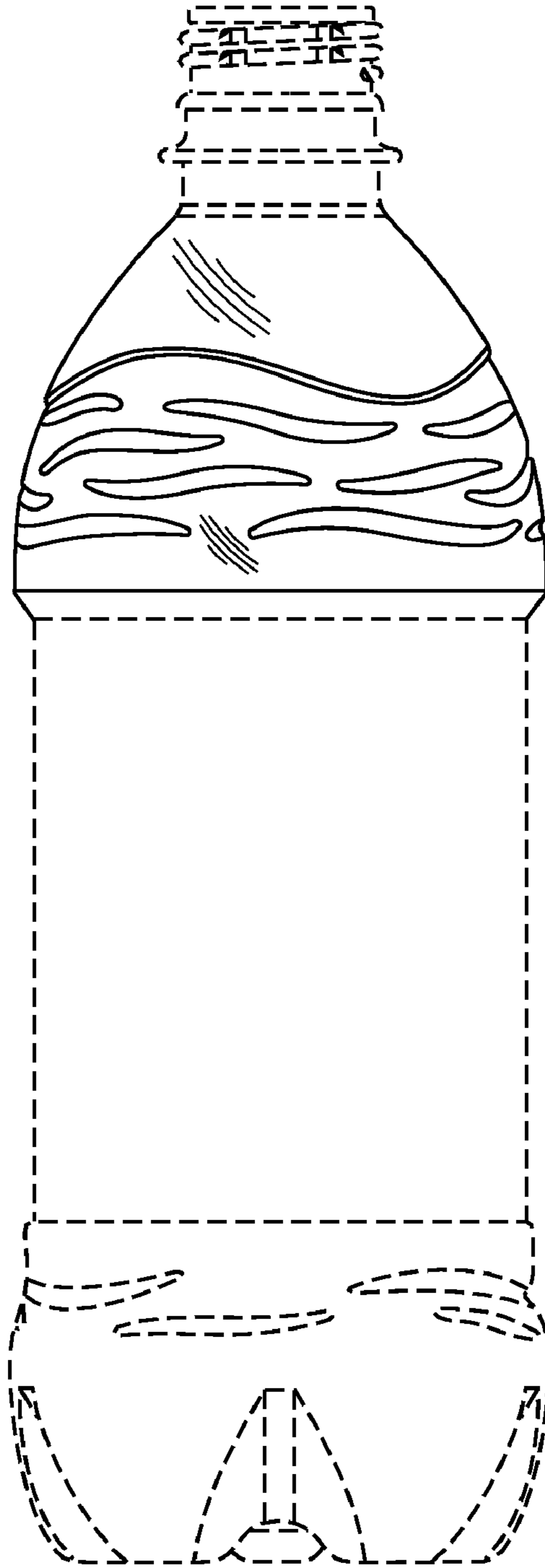

FIG. 2

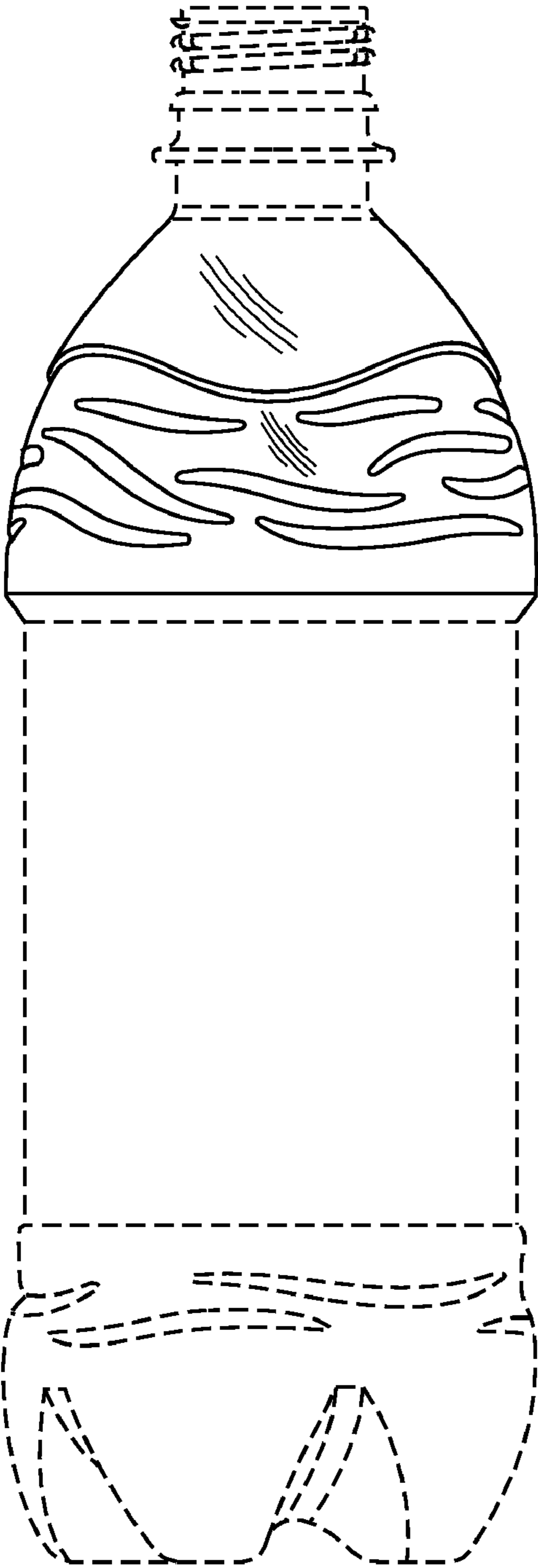

FIG. 3

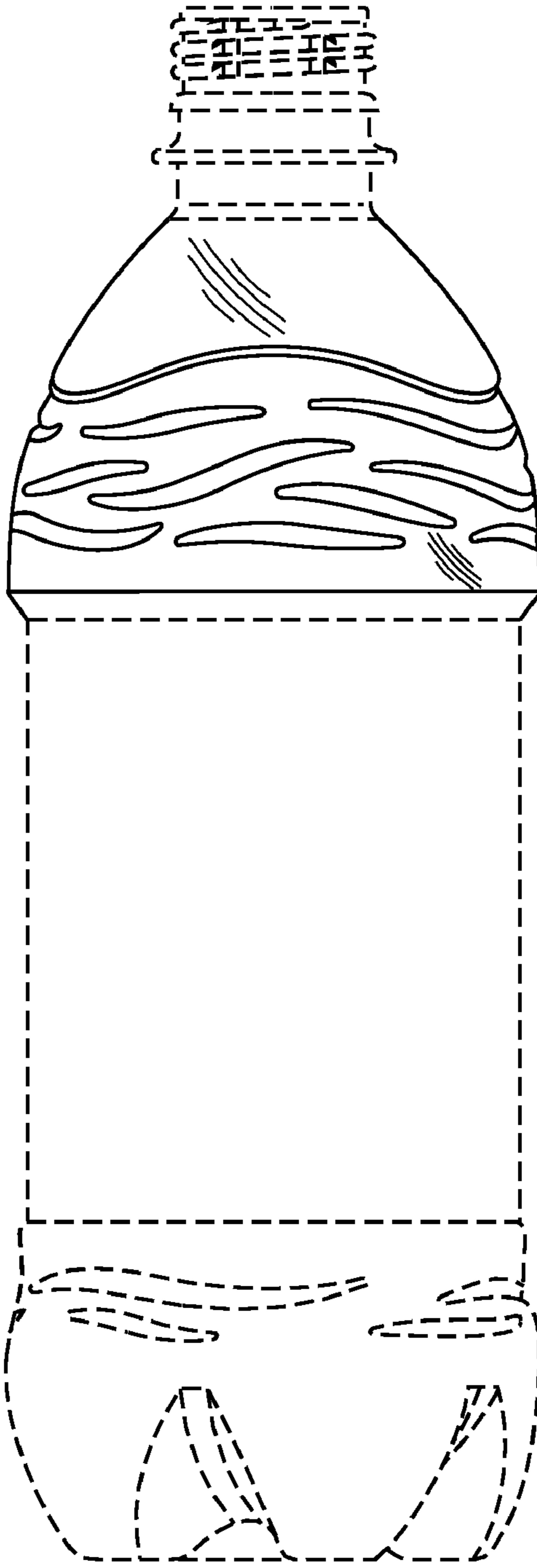

FIG. 4

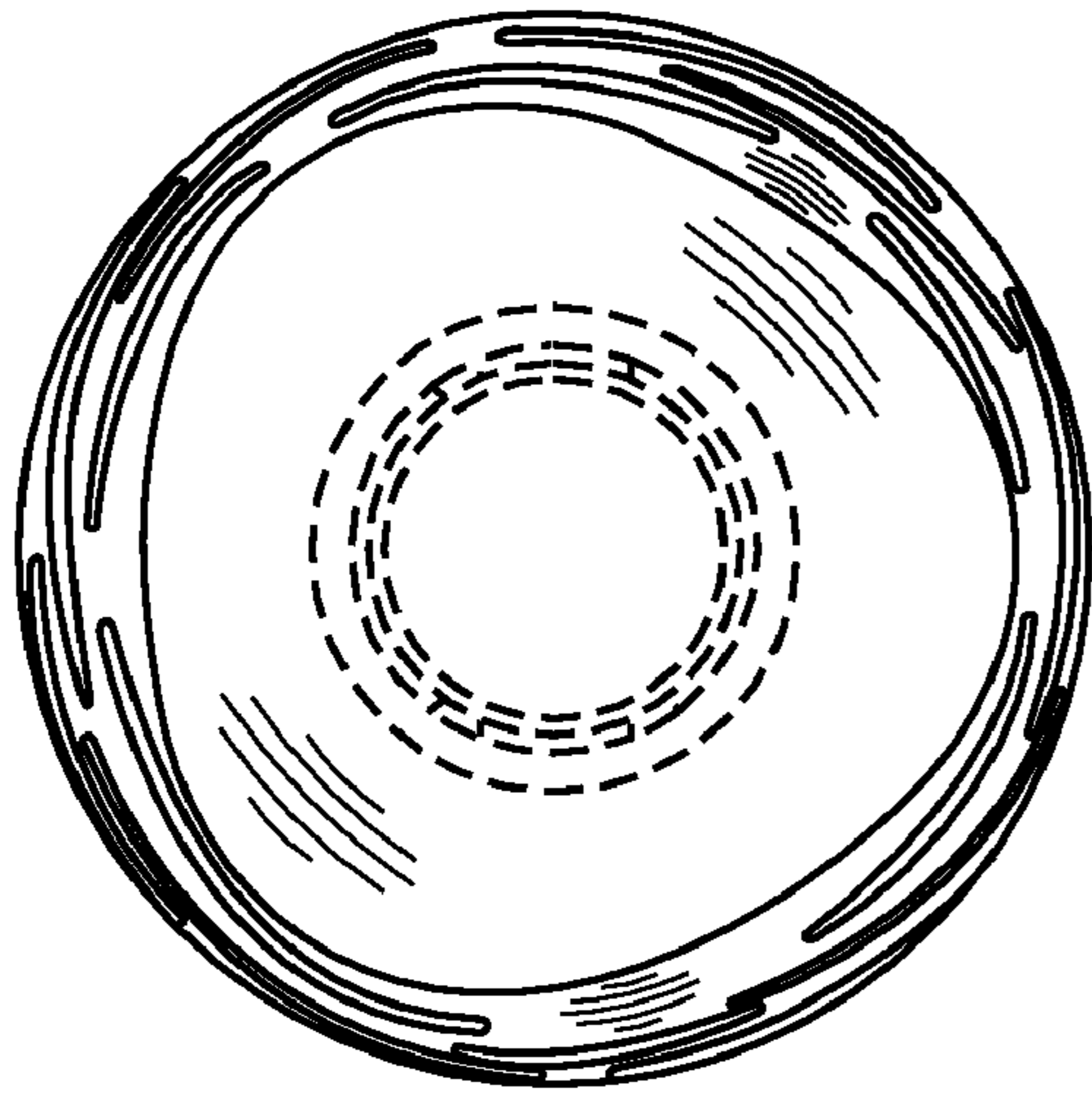

FIG. 5

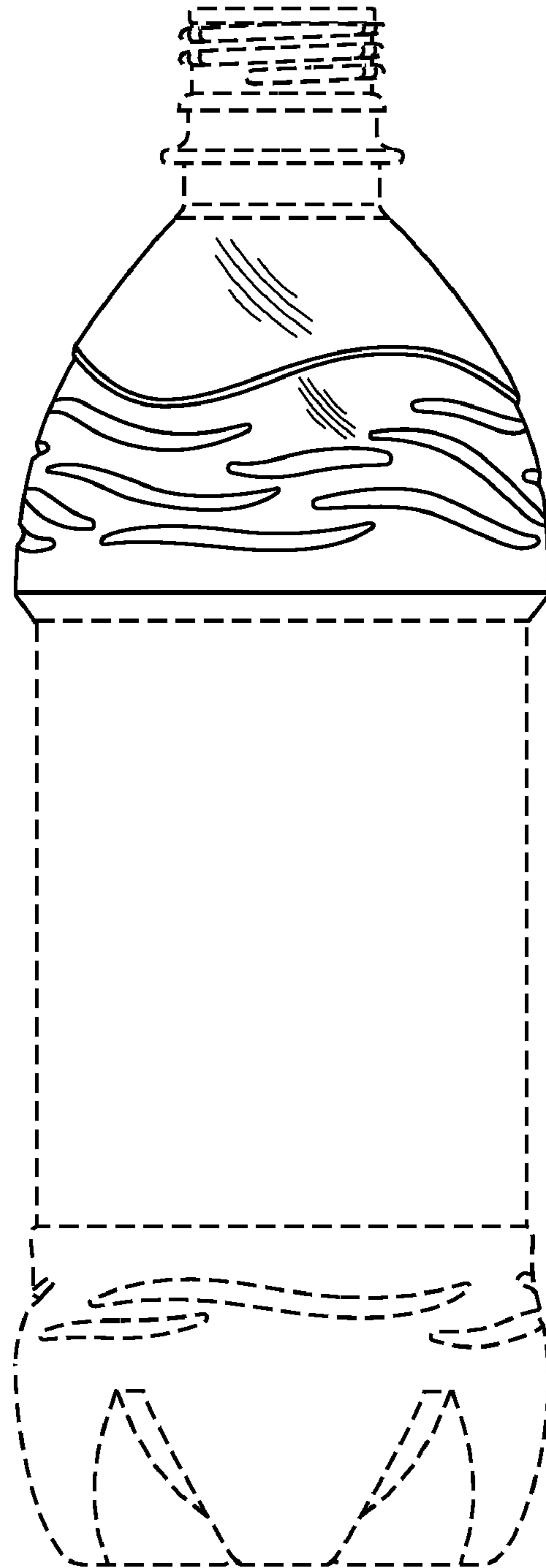

FIG. 6