

US00D568118S

(12) **United States Design Patent**
Chalfant et al.

(10) **Patent No.:** **US D568,118 S**

(45) **Date of Patent:** **** May 6, 2008**

(54) **BOX GRATER**

(75) Inventors: **Louis Chalfant**, Russellville, AR (US);
Carter W. McGuyer, Florence, AL
(US); **Christopher R. Grace**,
Russellville, AR (US)

(73) Assignee: **Grace Manufacturing Inc.**,
Russellville, AR (US)

(**) Term: **14 Years**

(21) Appl. No.: **29/281,053**

(22) Filed: **Jun. 14, 2007**

(51) **LOC (8) Cl.** **07-04**

(52) **U.S. Cl.** **D7/678**

(58) **Field of Classification Search** D7/678,
D7/672, 693; 241/92-95, 100, 168, 169,
241/169.1, 273.1-273.4, 274, 275, 285.2,
241/280, 287; 99/495, 508-513

See application file for complete search history.

(56) **References Cited**

U.S. PATENT DOCUMENTS

1,160,043 A * 11/1915 Clark 241/273.1
3,121,450 A * 2/1964 Cronheim 241/273.1

4,928,893 A * 5/1990 Prindle 241/95
D337,490 S * 7/1993 So D7/678
D343,098 S * 1/1994 Shun D7/678
D343,099 S * 1/1994 So D7/678
D473,110 S * 4/2003 Witthoft D7/678

* cited by examiner

Primary Examiner—Terry A Wallace

(74) *Attorney, Agent, or Firm*—Ladas & Parry LLP

(57) **CLAIM**

The ornamental design for a novel box grater, substantially as shown.

DESCRIPTION

FIG. 1 is a perspective view of a novel box grater constructed in accordance with the present invention; FIG. 2 is a left side elevation of the box grater of FIG. 1; FIG. 3 is a front elevation of the box grater of FIG. 1; FIG. 4 is a right side elevation of the box grater of FIG. 1; FIG. 5 is a rear view of the box grater of FIG. 1; FIG. 6 is a top plan view of the box grater of FIG. 1; and, FIG. 7 is a bottom plan view of the box grater of FIG. 1.

1 Claim, 2 Drawing Sheets

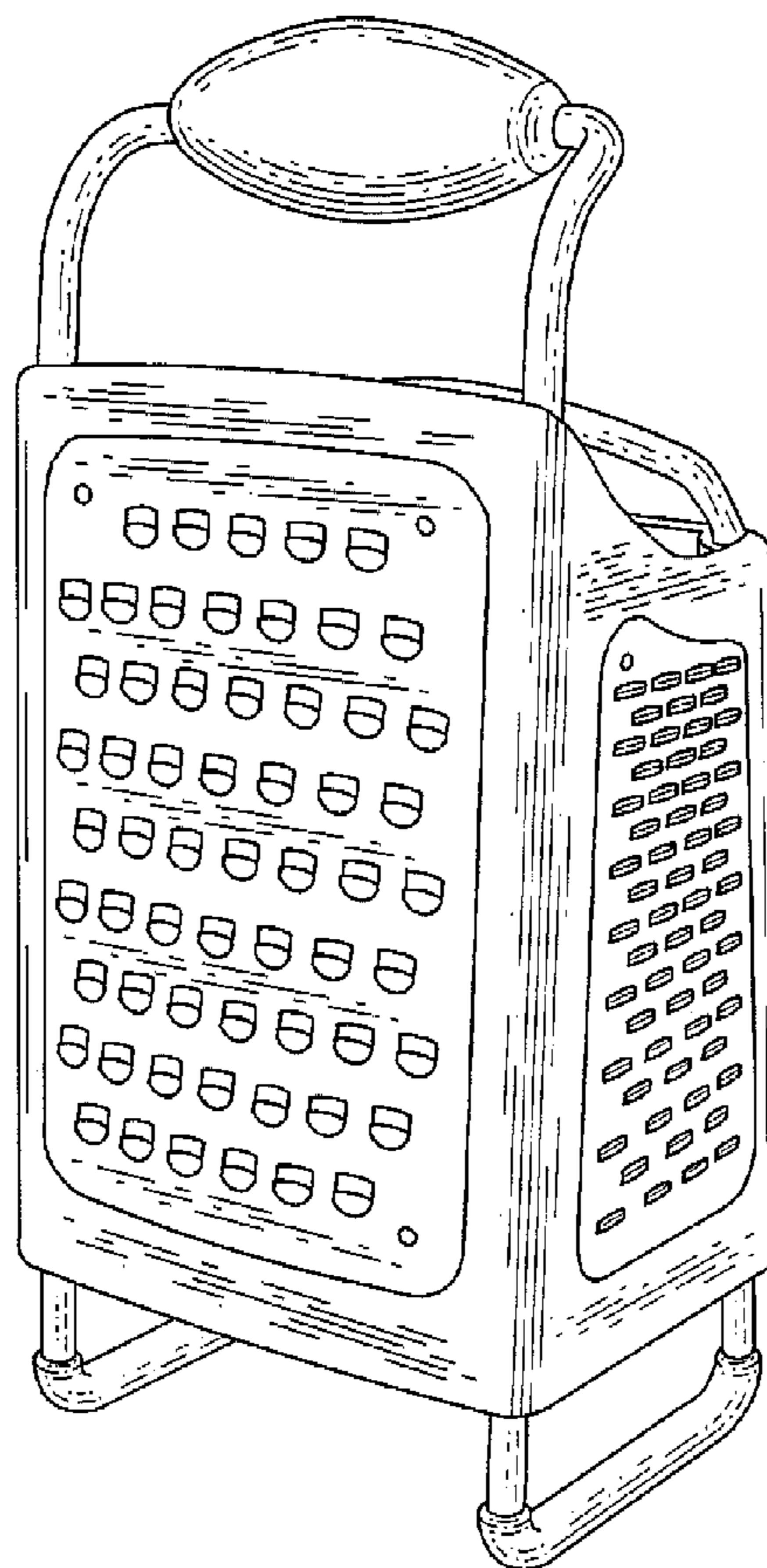

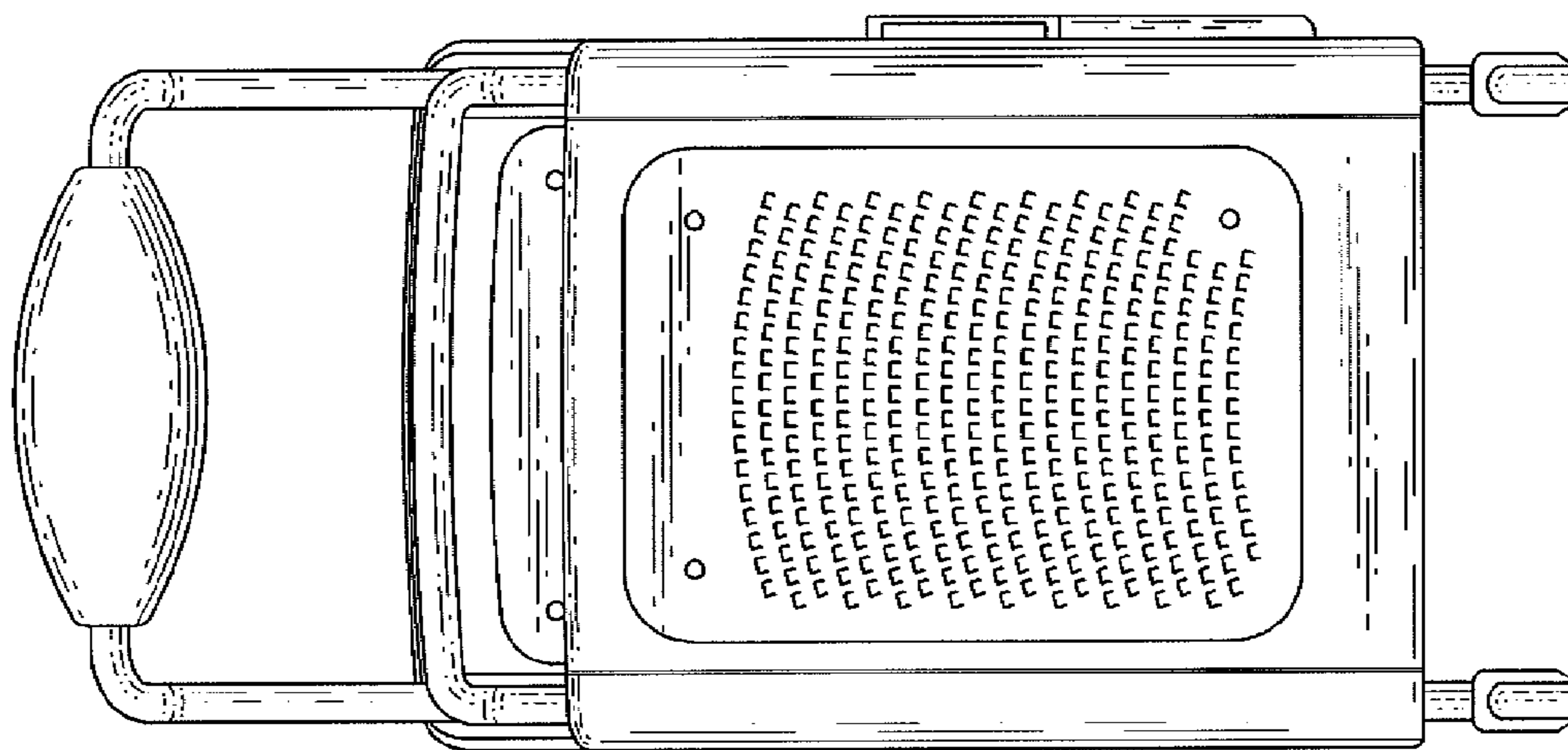

Fig. 3

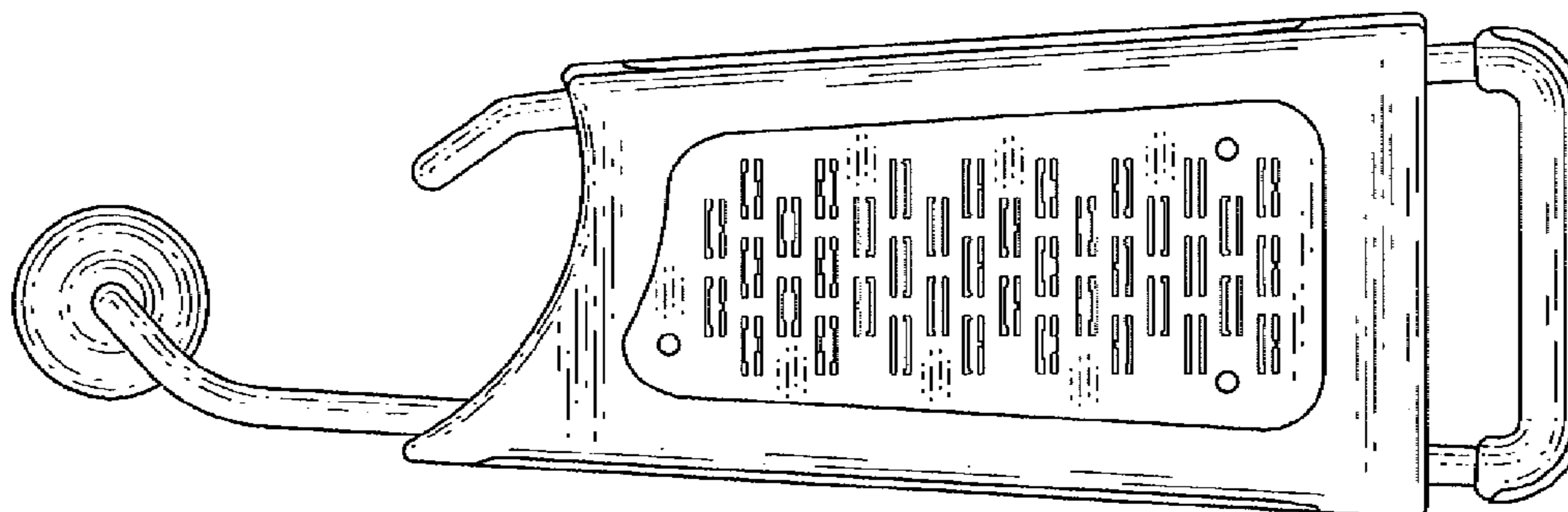

Fig. 2

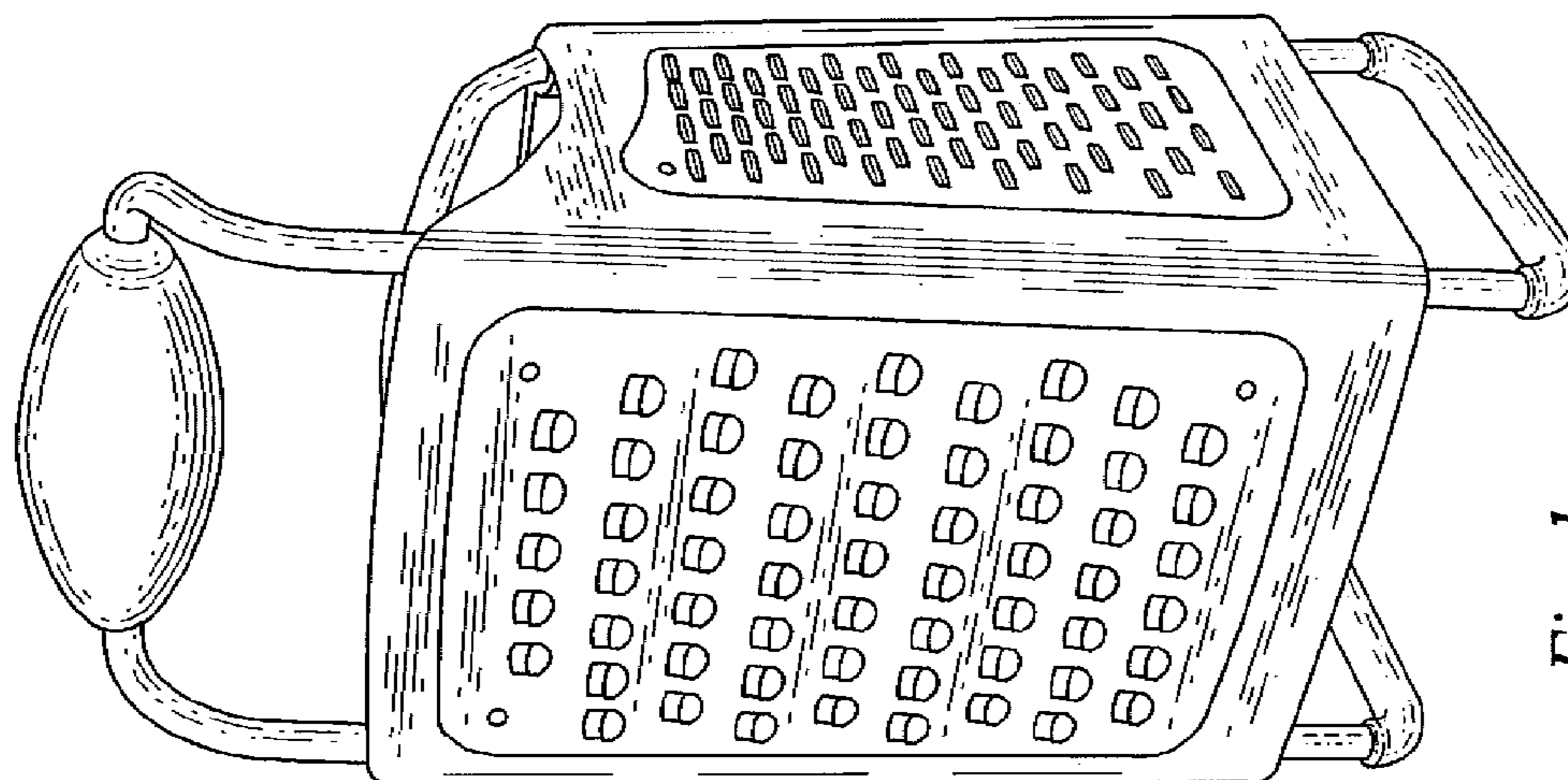

Fig. 1

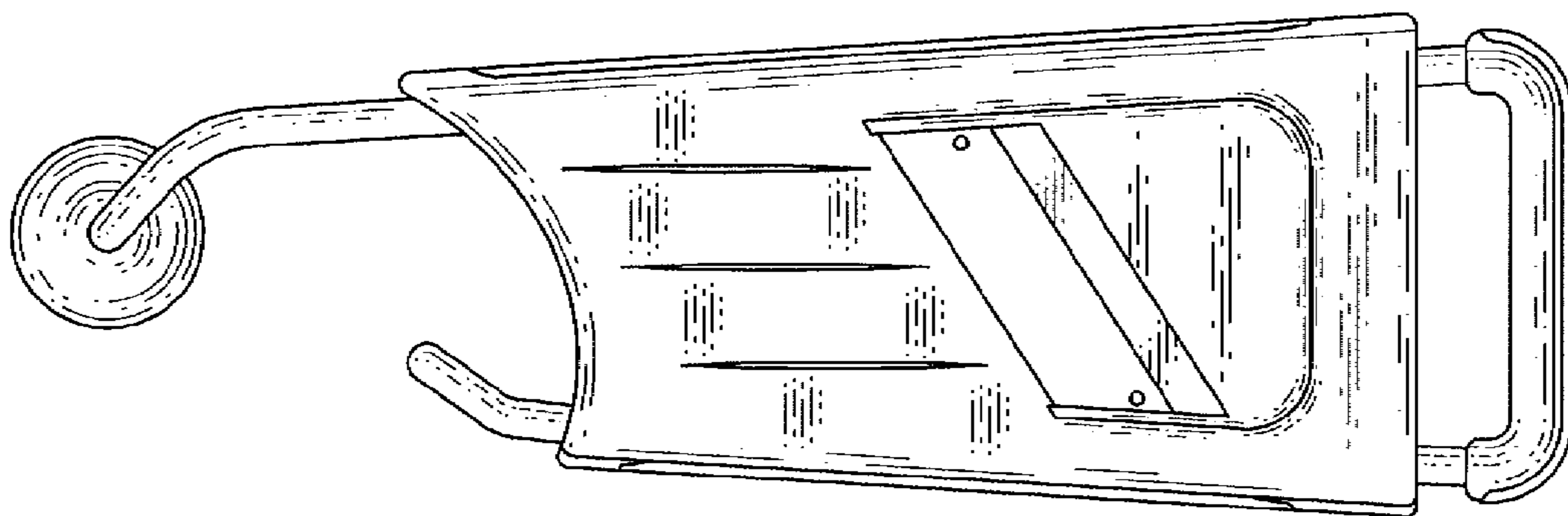

Fig. 4

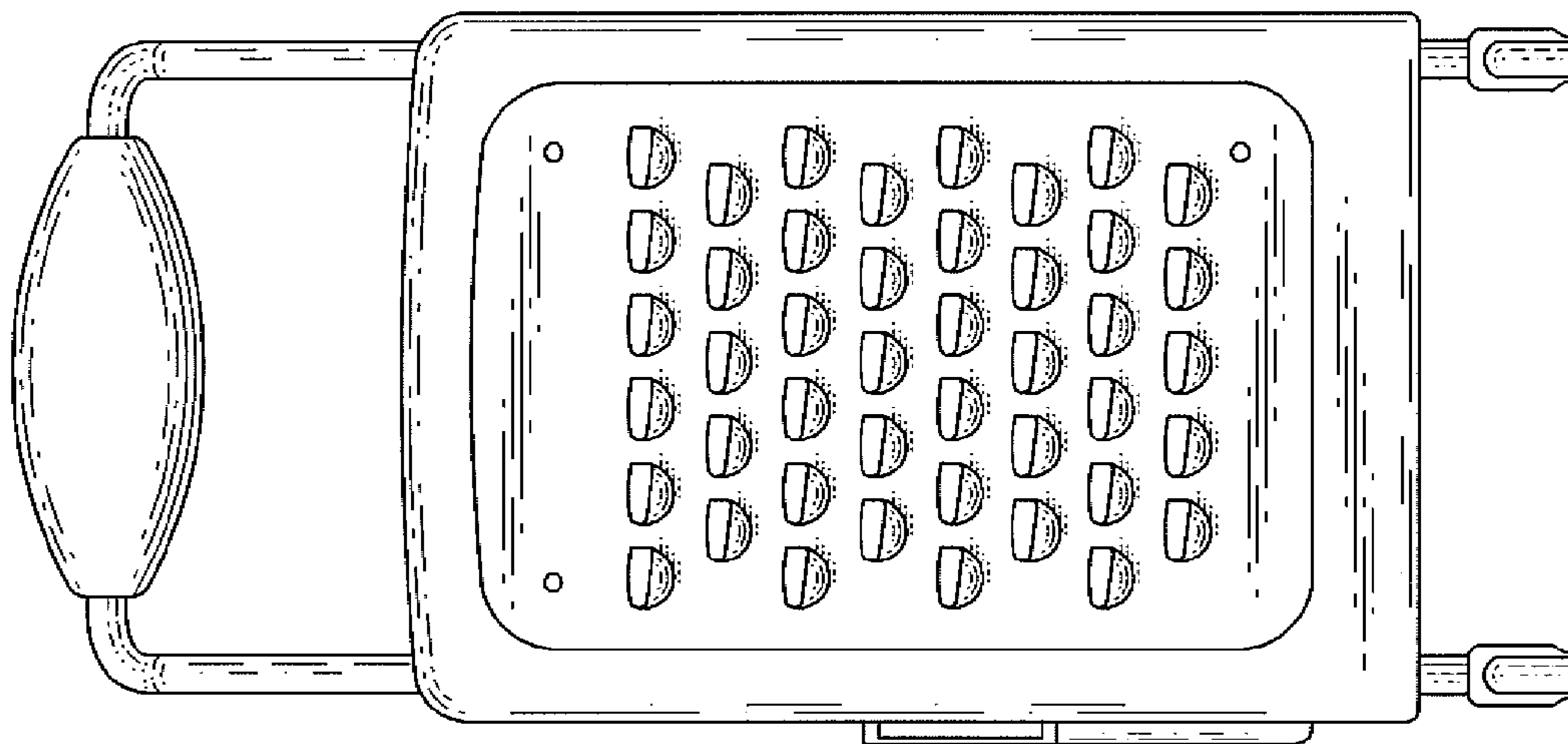

Fig. 5

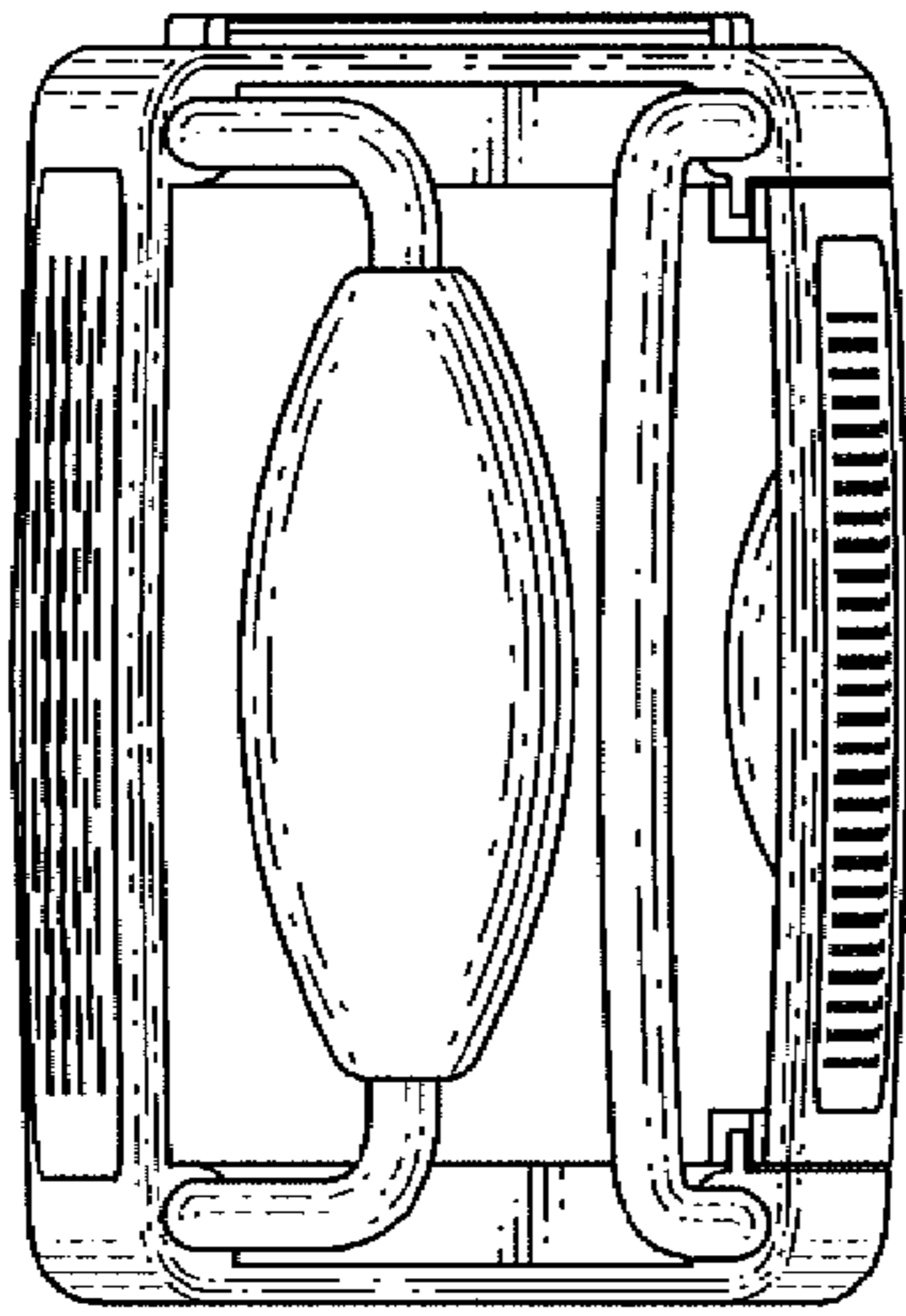

Fig. 6

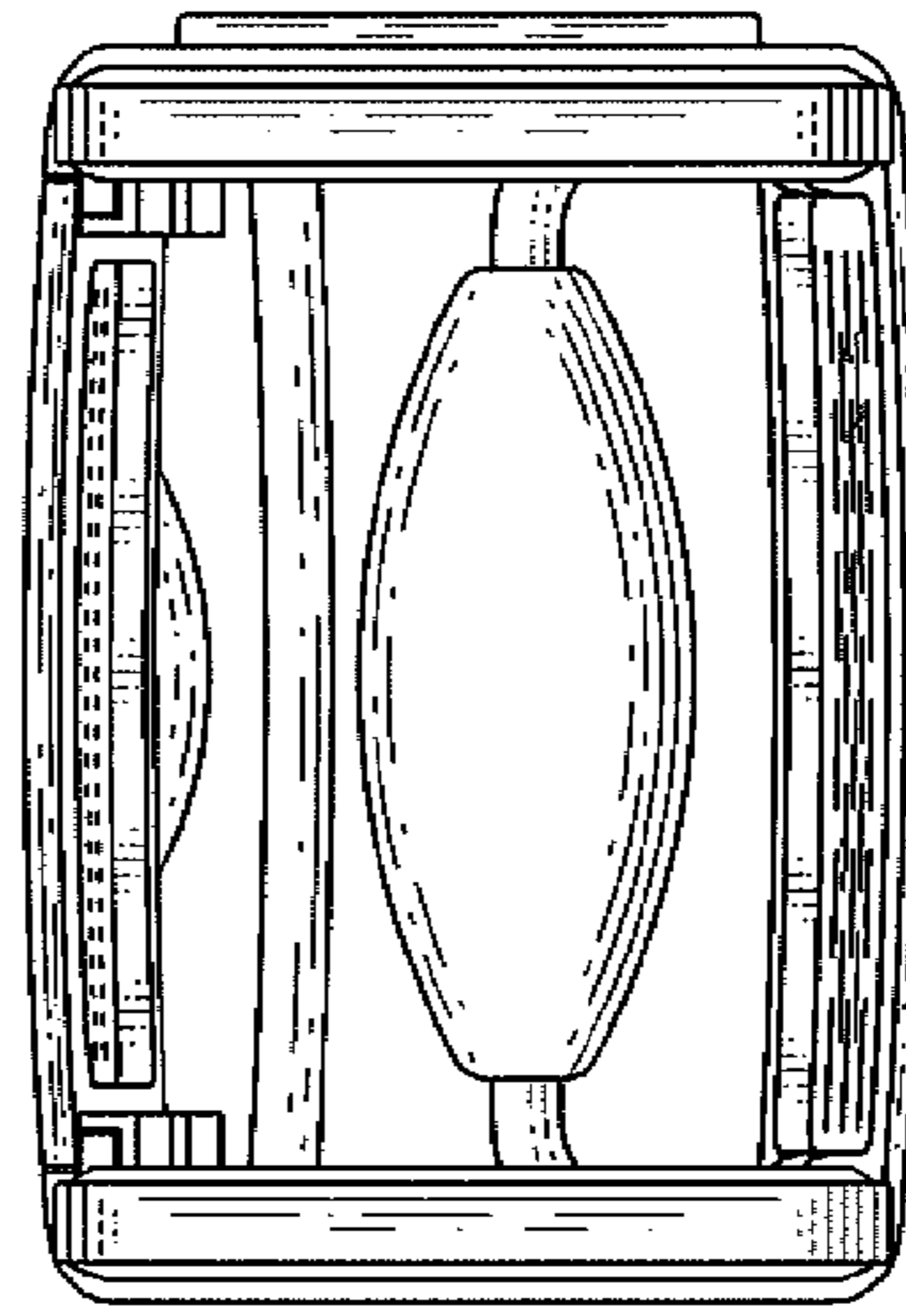

Fig. 7