

US00D567959S

(12) **United States Design Patent**
Williams et al.

(10) **Patent No.:** **US D567,959 S**

(45) **Date of Patent:** **** Apr. 29, 2008**

(54) **CHROMATOGRAPHY MEDIA DISPENSER**

(75) Inventors: **Alan M. Williams**, Easton, PA (US);
Roger Nordberg, Uppsala (SE)

(73) Assignee: **GE Healthcare Bio-Sciences AB**,
Uppsala (SE)

(**) Term: **14 Years**

(21) Appl. No.: **29/284,888**

(22) Filed: **Sep. 18, 2007**

(30) **Foreign Application Priority Data**

Mar. 23, 2007 (EM) 000694997-0001

(51) **LOC (8) Cl.** **24-01**

(52) **U.S. Cl.** **D24/216**

(58) **Field of Classification Search** D24/216-230,
D24/127, 128, 231, 232; 422/100-104; D10/81,
D10/103; 210/656-659

See application file for complete search history.

(56) **References Cited**

U.S. PATENT DOCUMENTS

D183,353 S * 8/1958 Kopp D24/227
D183,528 S * 9/1958 Kopp D24/232
2,909,469 A * 10/1959 Griffith 422/198
D198,160 S * 5/1964 Thompson D24/232
D203,174 S * 12/1965 Luft D24/222
D230,099 S * 1/1974 Orr D24/226
4,263,144 A * 4/1981 Platt 210/658
D306,266 S * 2/1990 Hargrove et al. D24/224
4,935,041 A * 6/1990 Lawrence et al. 422/102

D399,972 S * 10/1998 Foscato D24/232
D413,678 S * 9/1999 Anderson et al. D24/232
D437,797 S * 2/2001 Bishop D10/103
D551,104 S * 9/2007 Wounder D24/224

* cited by examiner

Primary Examiner—Lou Zarfaz

Assistant Examiner—Anhdao Doan

(74) *Attorney, Agent, or Firm*—Dwayne L. Bentley

(57) **CLAIM**

The ornamental design for a chromatography media dispenser, as shown and described.

DESCRIPTION

FIG. 1 is a perspective view of the first embodiment of a chromatography media dispenser.

FIG. 2 is a front view of the chromatography media dispenser of FIG. 1.

FIG. 3 is a back view of the chromatography media dispenser of FIG. 1.

FIG. 4 is a left side view of the chromatography media dispenser of FIG. 1.

FIG. 5 is a right side view of the chromatography media dispenser of FIG. 1.

FIG. 6 is a top plan view of the chromatography media dispenser of FIG. 1; and,

FIG. 7 is a bottom plan view of the chromatography media dispenser of FIG. 1.

1 Claim, 7 Drawing Sheets

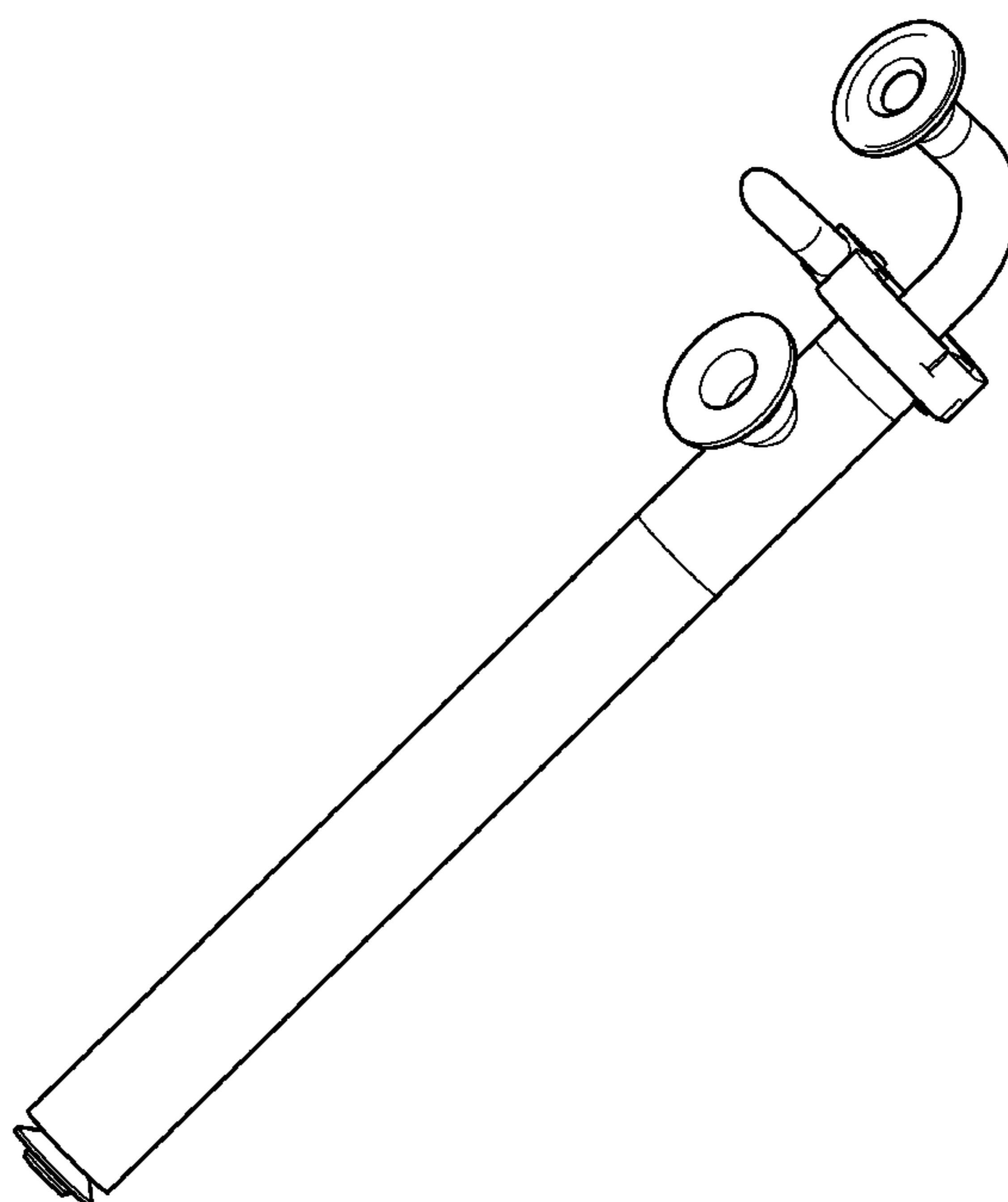

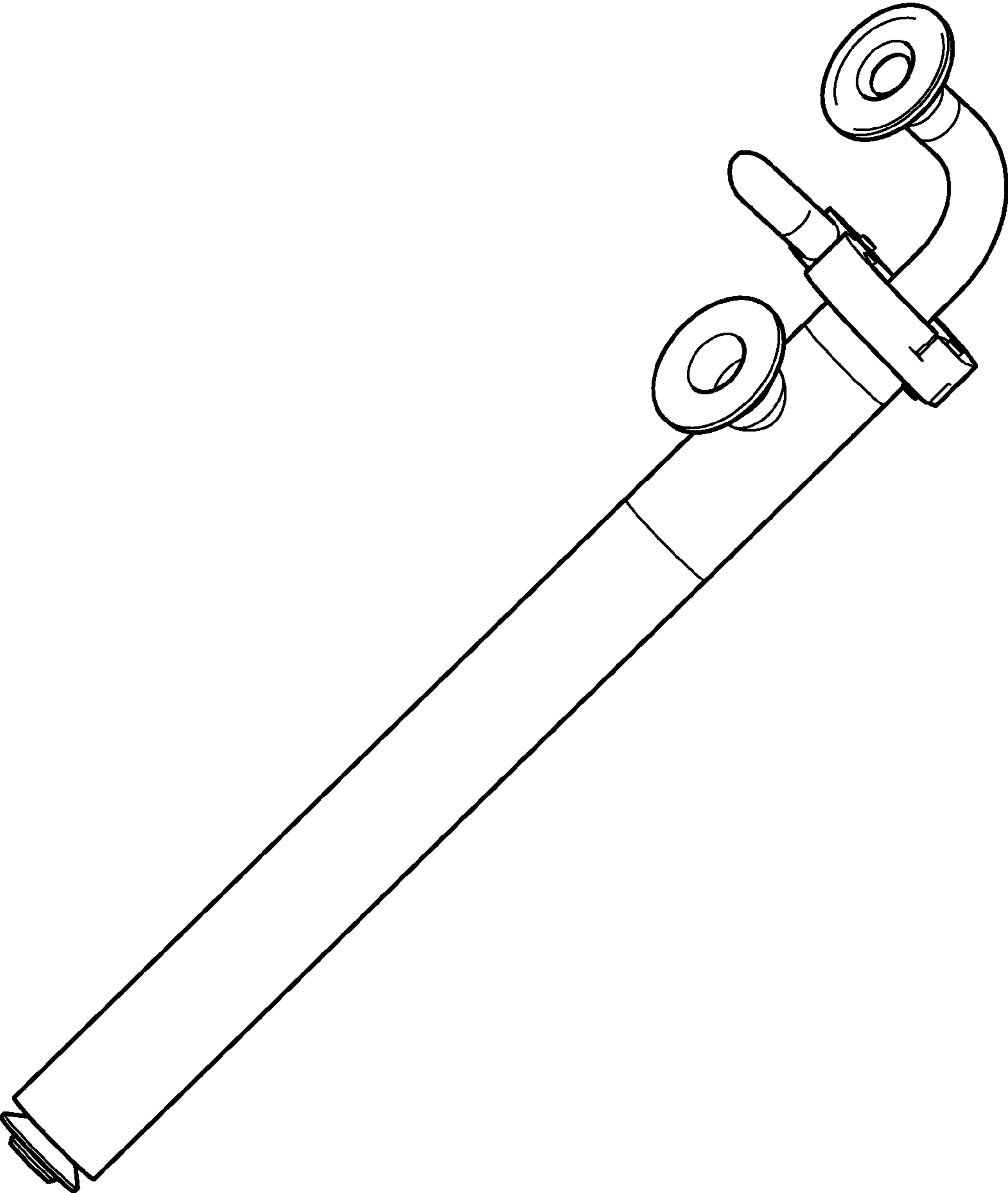

Figure 1

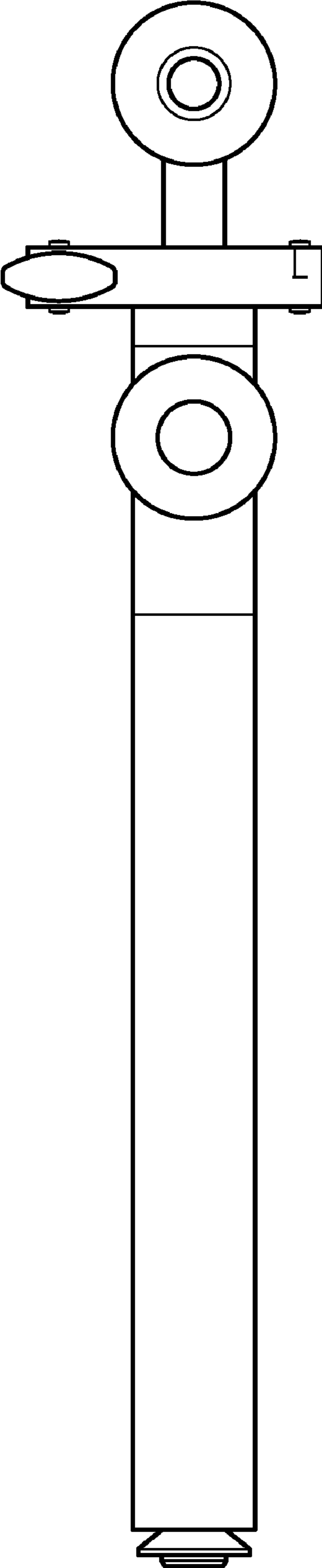

Figure 2

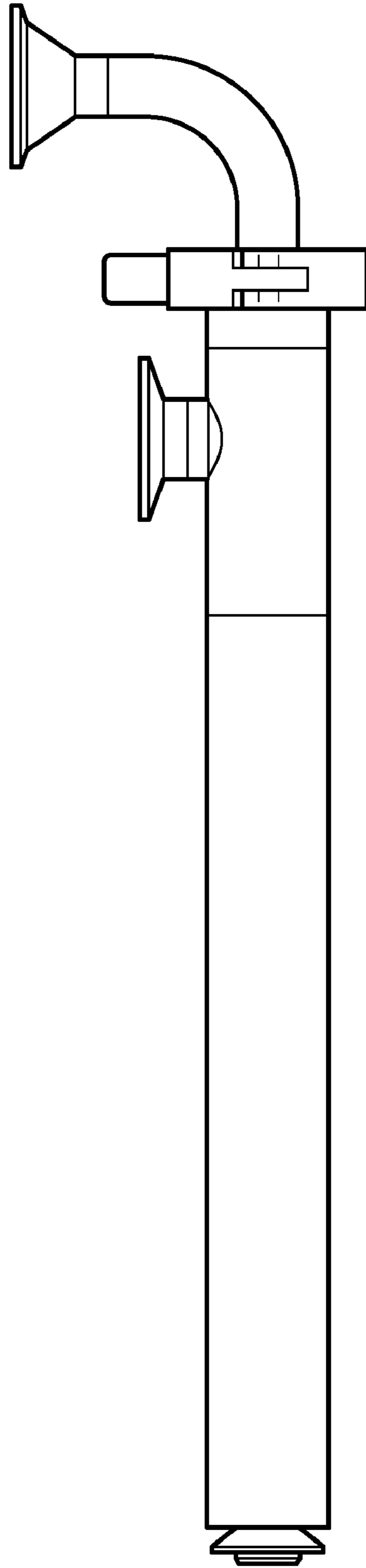

Figure 3

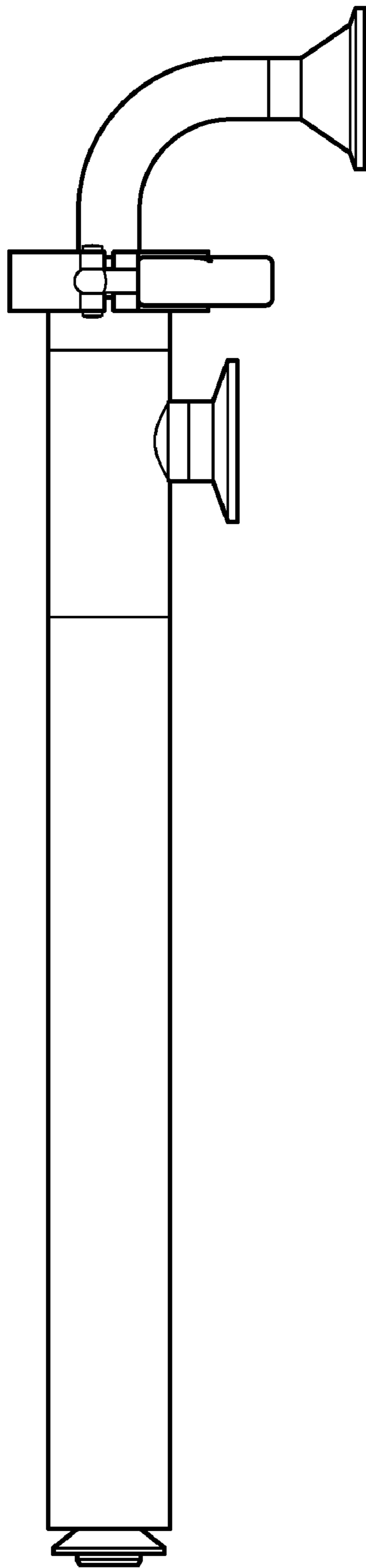

Figure 4

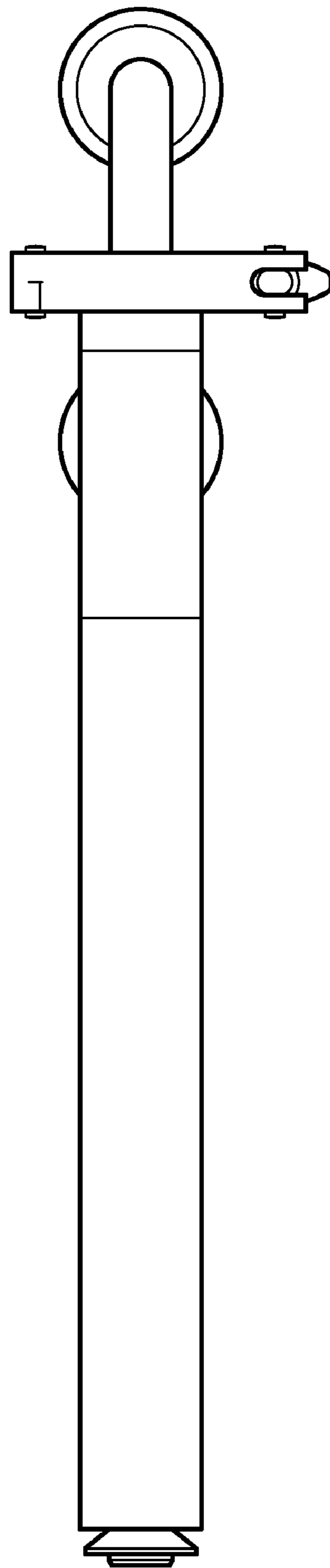

Figure 5

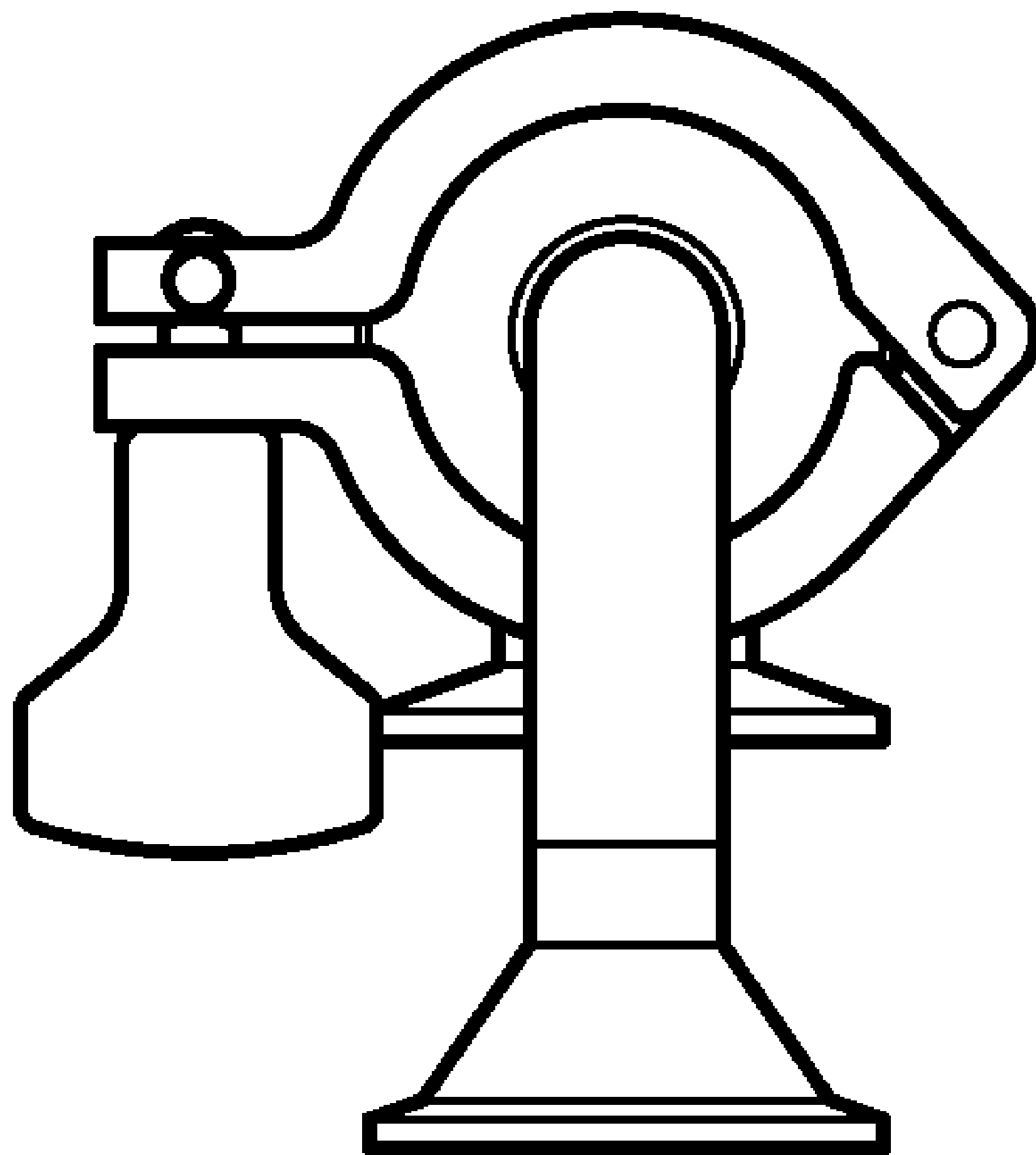

Figure 6

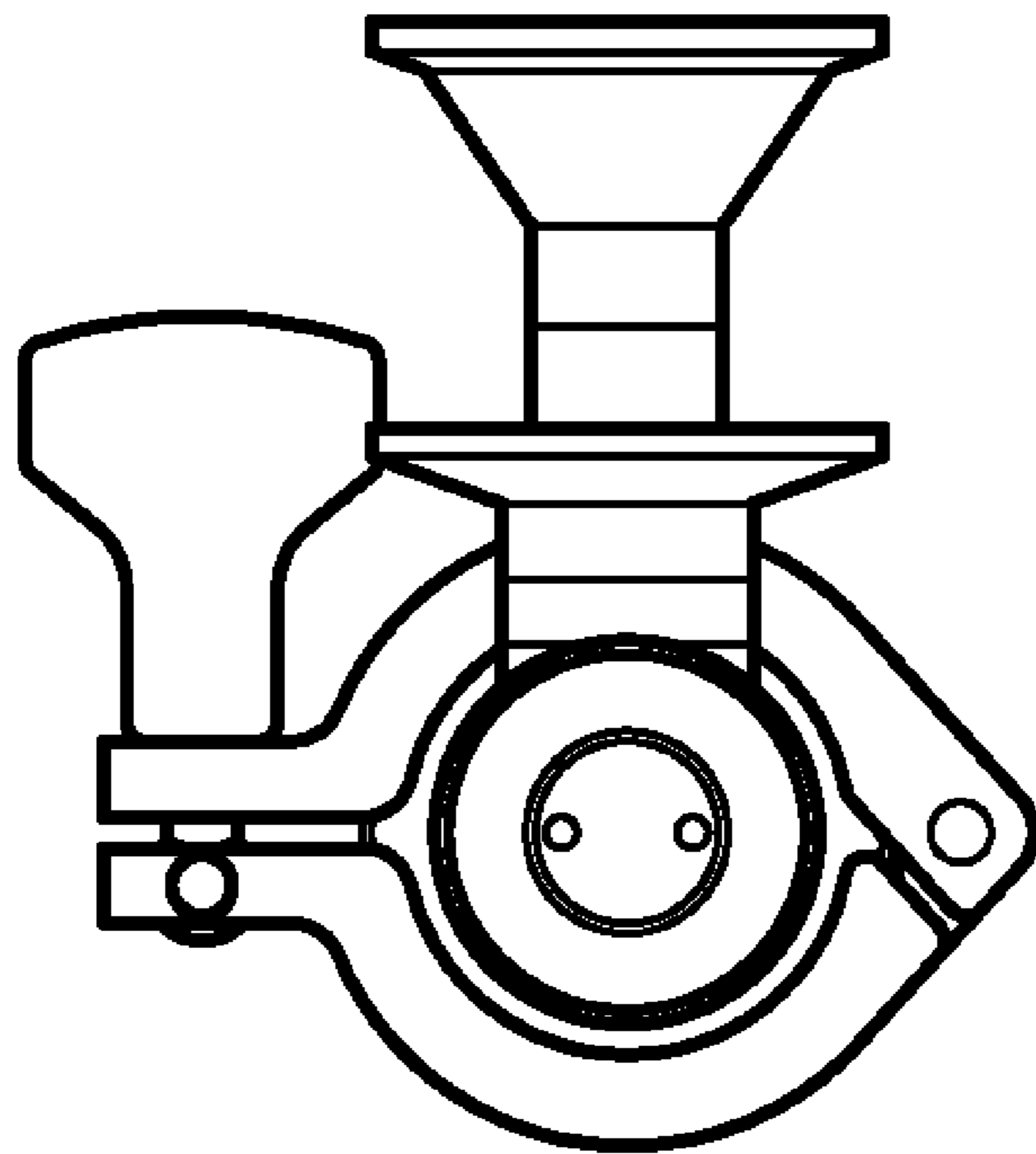

Figure 7