



US00D567903S

(12) **United States Design Patent**
Rigolio

(10) **Patent No.:** **US D567,903 S**

(45) **Date of Patent:** **** Apr. 29, 2008**

(54) **APPLICATOR GUN**

(75) Inventor: **Riccardo Rigolio**, Varese (IT)

(73) Assignee: **Rigo S.R.L.**, Varese (IT)

(**) Term: **14 Years**

(21) Appl. No.: **29/270,021**

(22) Filed: **Dec. 13, 2006**

(30) **Foreign Application Priority Data**

Jul. 27, 2006 (EM) 000566740-0001
Jul. 27, 2006 (EM) 000566740-0006

(51) **LOC (8) Cl.** **23-01**

(52) **U.S. Cl.** **D23/226**

(58) **Field of Classification Search** D23/213,
D23/223, 226; D32/32; D8/14.1, 30; 239/332,
239/375; 366/131, 336; 118/300, 308
See application file for complete search history.

(56) **References Cited**

U.S. PATENT DOCUMENTS

D202,216 S * 9/1965 Liljemark D23/226
5,053,202 A * 10/1991 Dwyer et al. 422/135

5,538,190 A * 7/1996 Greene et al. 239/708
5,683,544 A * 11/1997 Kopp 156/578
5,749,968 A * 5/1998 Melanson et al. 118/300
D507,036 S * 7/2005 Khaitov D23/226

* cited by examiner

Primary Examiner—Robin V Webster

(74) *Attorney, Agent, or Firm*—James V. Costigan; Hedman & Costigan, P.C.

(57) **CLAIM**

The ornamental design for an applicator gun, as shown and described.

DESCRIPTION

FIG. 1 is a front perspective view of the invention;
FIG. 2 is a left side view of the invention;
FIG. 3 is a right side view of the invention;
FIG. 4 is a front view of the invention;
FIG. 5 is a back view of the invention;
FIG. 6 is a top view of the invention; and,
FIG. 7 is a bottom view of the invention.

1 Claim, 7 Drawing Sheets

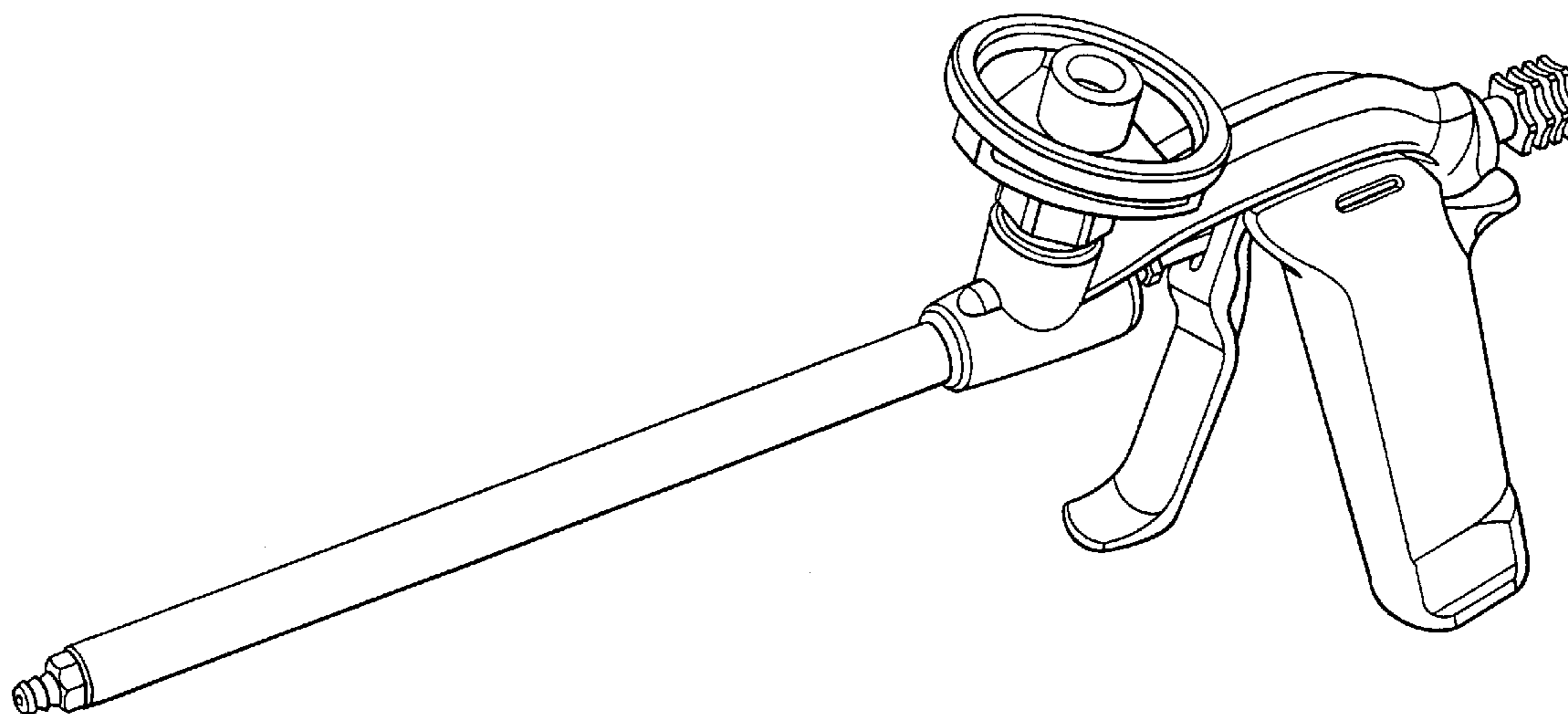

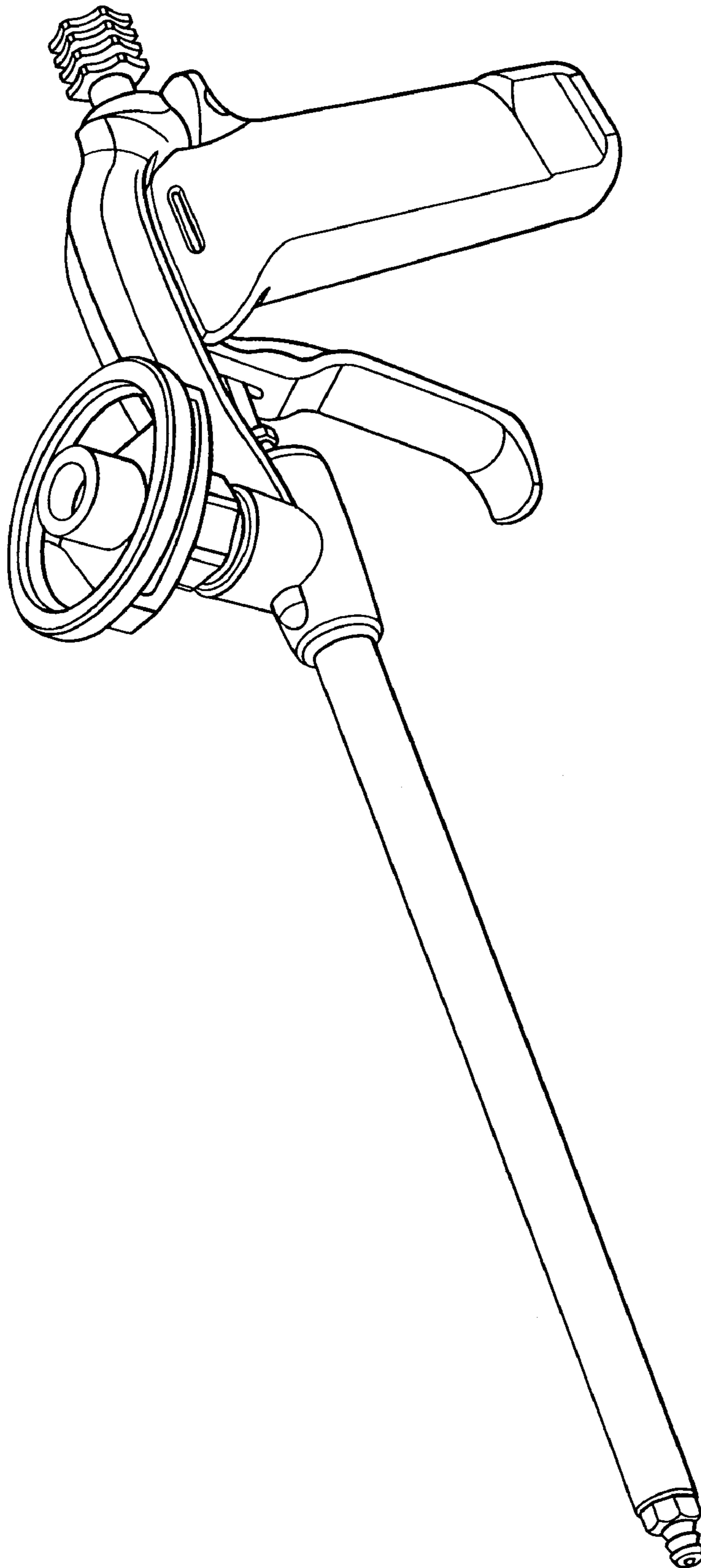

FIG 1

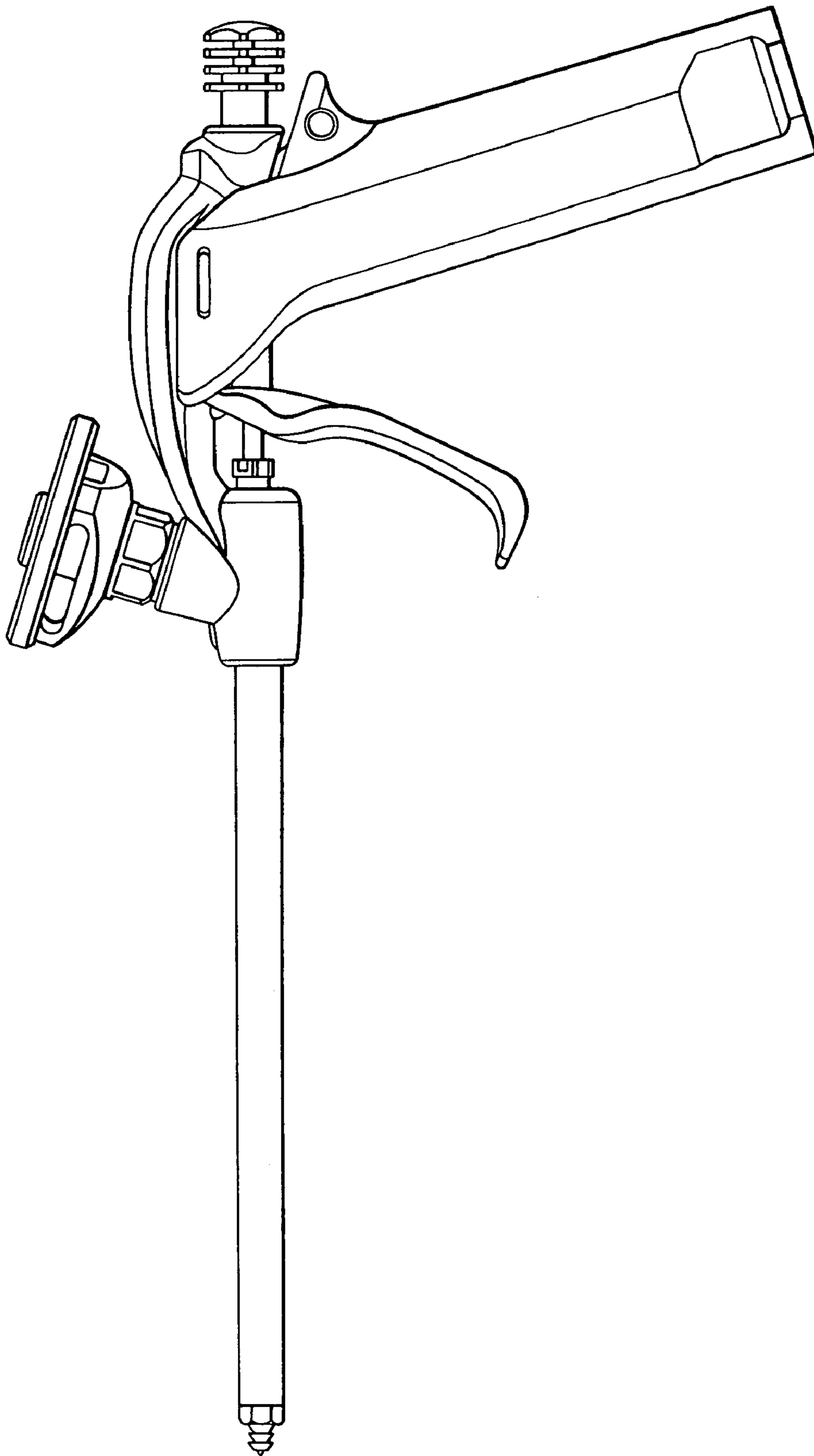

FIG 2

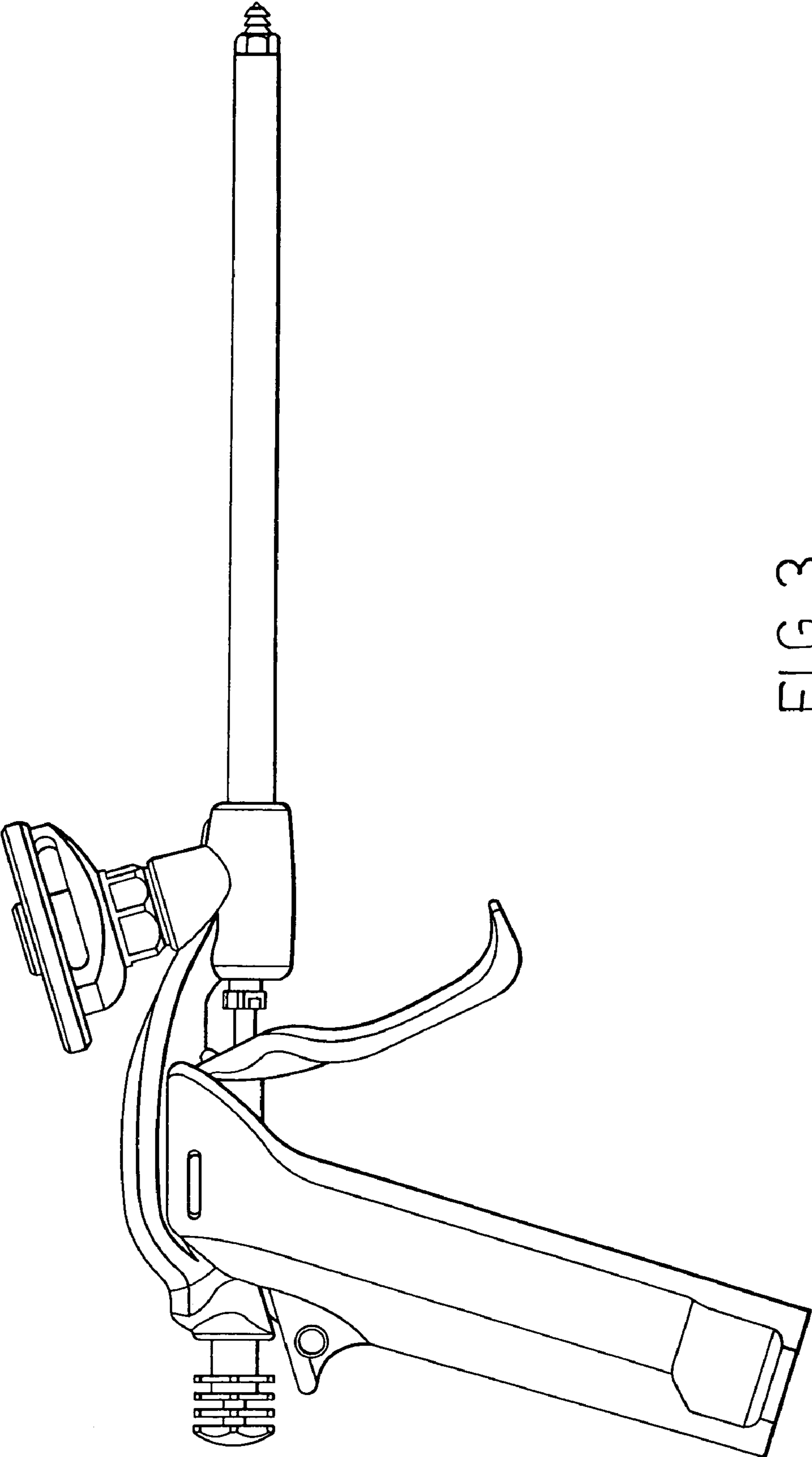

FIG 3

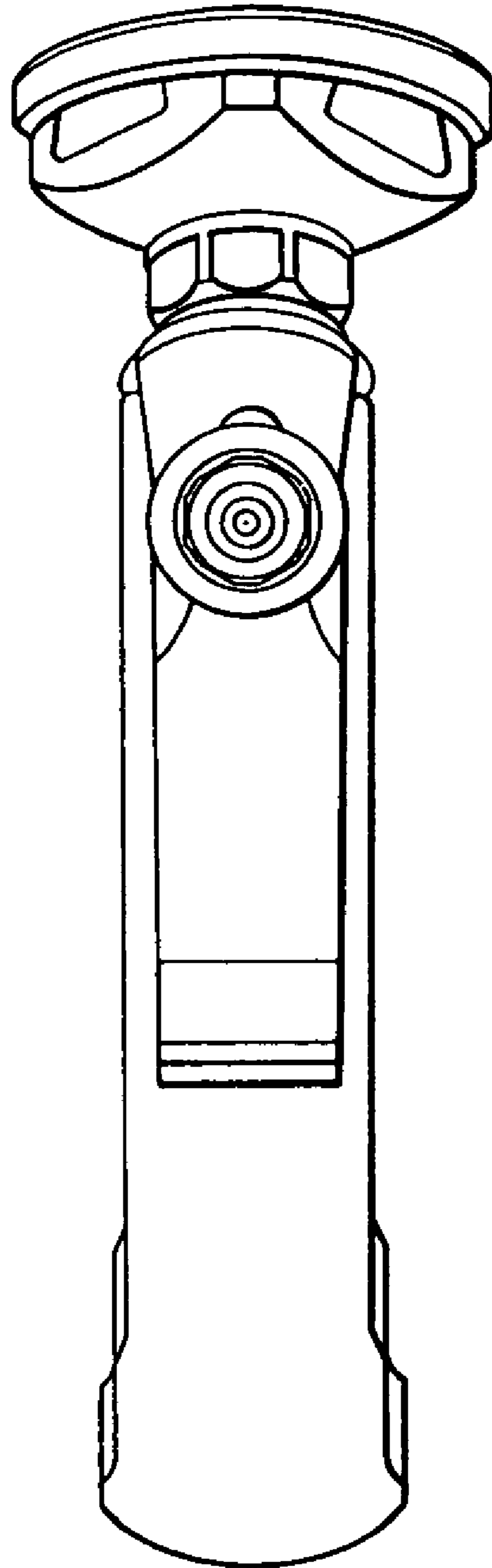

FIG 4

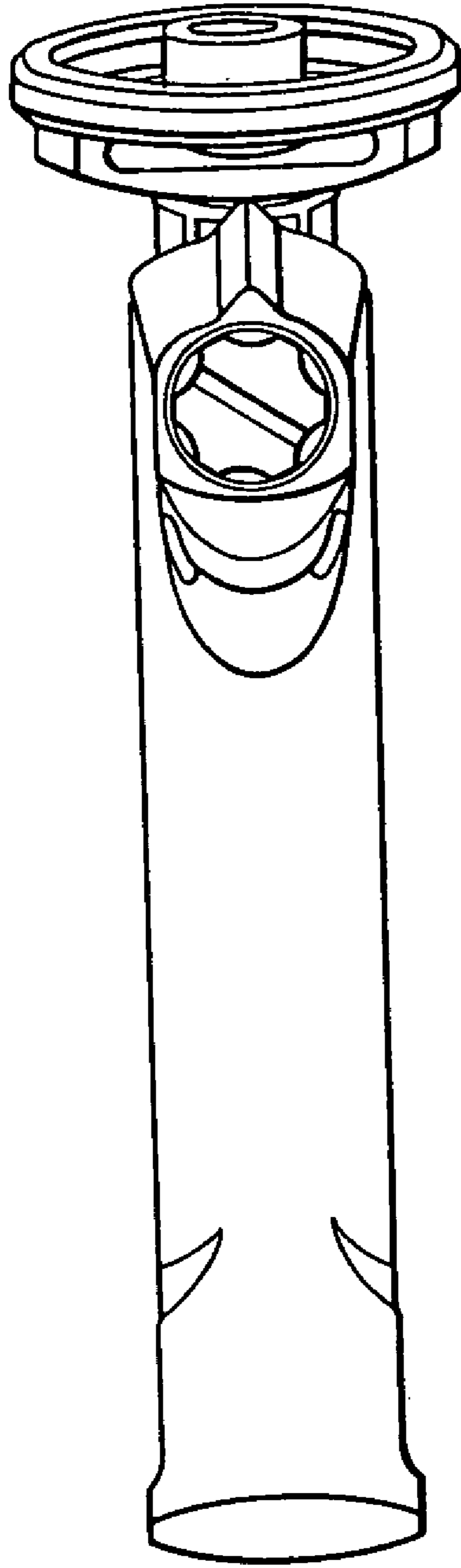

FIG 5

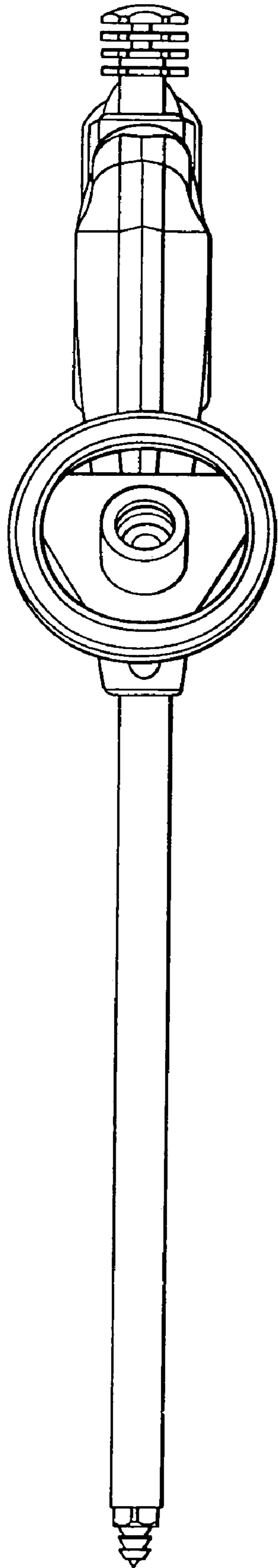

FIG 6

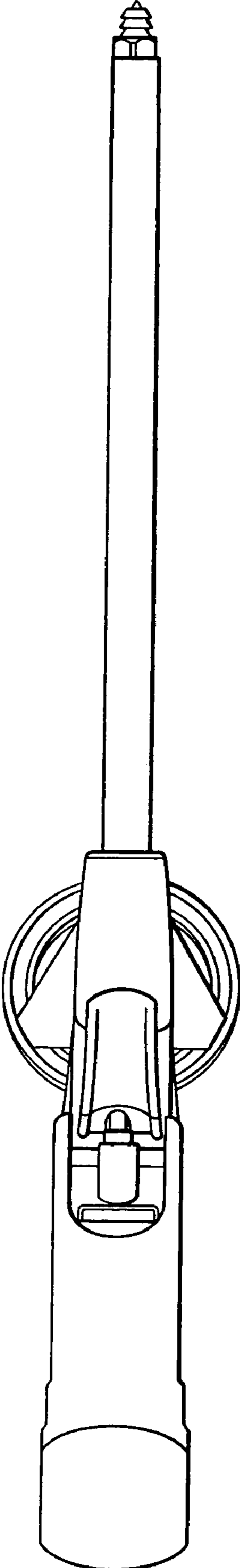

FIG 7