



US00D567892S

(12) **United States Design Patent**  
**Wagen et al.**

(10) **Patent No.:** **US D567,892 S**  
(45) **Date of Patent:** **\*\* Apr. 29, 2008**

(54) **GOLF SHORT GAME TRAINING DEVICE  
AND MOUNTING CLIP**

(76) Inventors: **Thomas A. Wagen**, 9716 Belladonna  
Dr., San Ramon, CA (US) 94582;  
**Lewis C. Knapp**, 1124 Harper Ct.,  
Santa Cruz, CA (US) 95062

(\*\*) Term: **14 Years**

(21) Appl. No.: **29/272,782**

(22) Filed: **Feb. 15, 2007**

(51) **LOC (8) Cl.** ..... **21-02**

(52) **U.S. Cl.** ..... **D21/791**

(58) **Field of Classification Search** ..... D21/789,  
D21/791; 473/219, 226, 231-265  
See application file for complete search history.

(56) **References Cited**

**U.S. PATENT DOCUMENTS**

3,834,697	A *	9/1974	McNamara et al.	.....	473/256
D290,150	S *	6/1987	Stewart	.....	D21/759
5,776,006	A *	7/1998	Gruber	.....	473/256
6,120,385	A *	9/2000	Nemeckay	.....	473/256
D438,585	S *	3/2001	Pelot	.....	D21/753
6,612,936	B1 *	9/2003	Matias	.....	473/256
D485,325	S *	1/2004	Rohan-Weaver	.....	D21/789
7,048,640	B2 *	5/2006	Light	.....	473/256
7,121,953	B2 *	10/2006	Simpson	.....	473/226

\* cited by examiner

*Primary Examiner*—Mitchell Siegel

(74) *Attorney, Agent, or Firm*—Brian Beverly; Beeson  
Skinner Beverly, LLP

(57) **CLAIM**

The ornamental design for a golf short game training device  
and mounting clip, as shown and described.

**DESCRIPTION**

FIG. 1 is a perspective view of a short game training device  
and mounting clip.

FIG. 2 is an enlarged exploded view thereof;

FIG. 3 is a front elevation view of the training device for  
clarity of illustration;

FIG. 4 is a right-side elevation of the training device thereof,  
the left side being a mirror image;

FIG. 5 is a rear elevation view of the training device.

FIG. 6 is a top plan view of the training device.

FIG. 7 is a bottom plan view of the training device.

FIG. 8 is a front elevation view of the clip for clarity of  
illustration;

FIG. 9 is a right side elevation view of the clip.

FIG. 10 is a rear plan view of the clip.

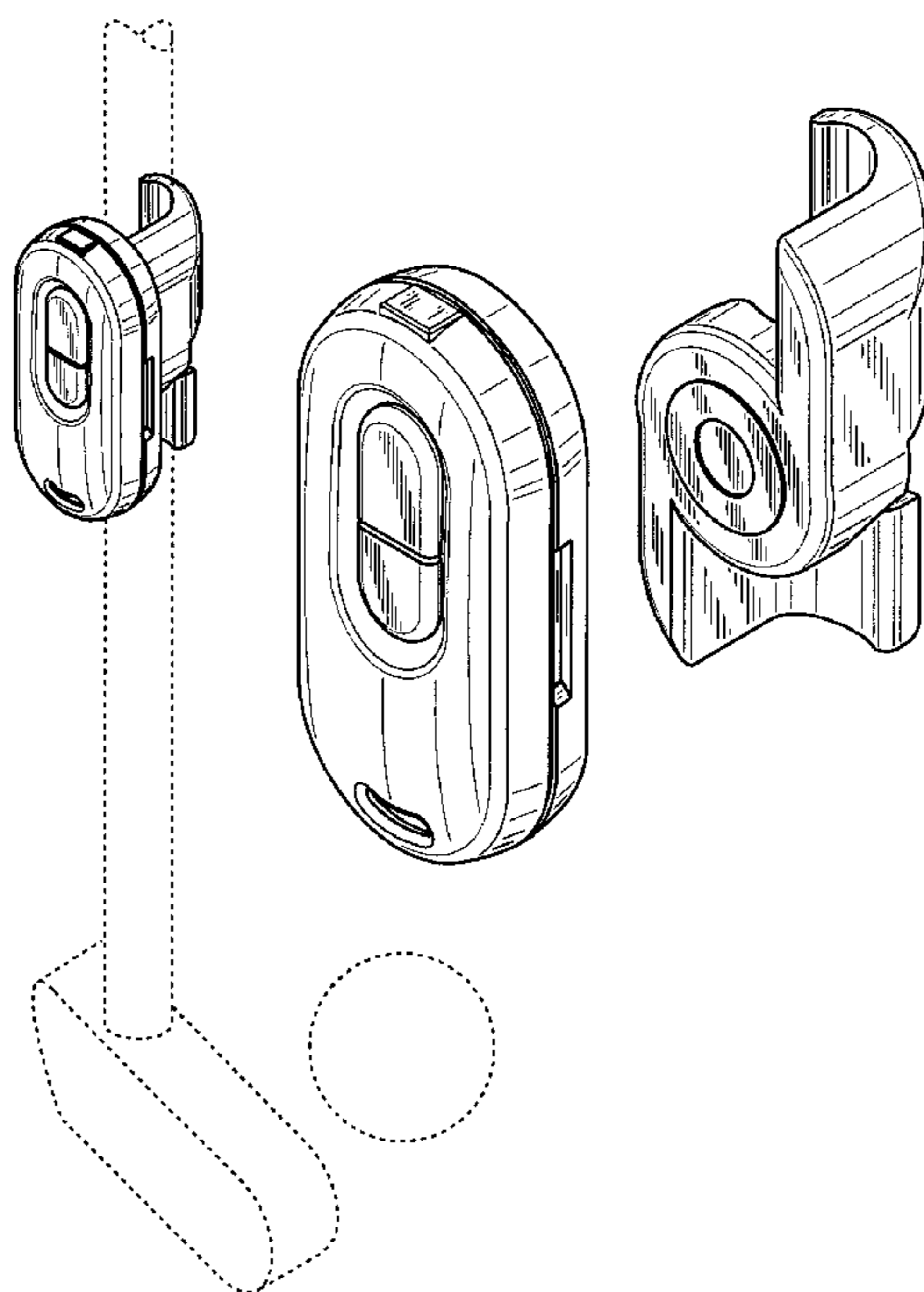
FIG. 11 is a left side elevation view of the clip.

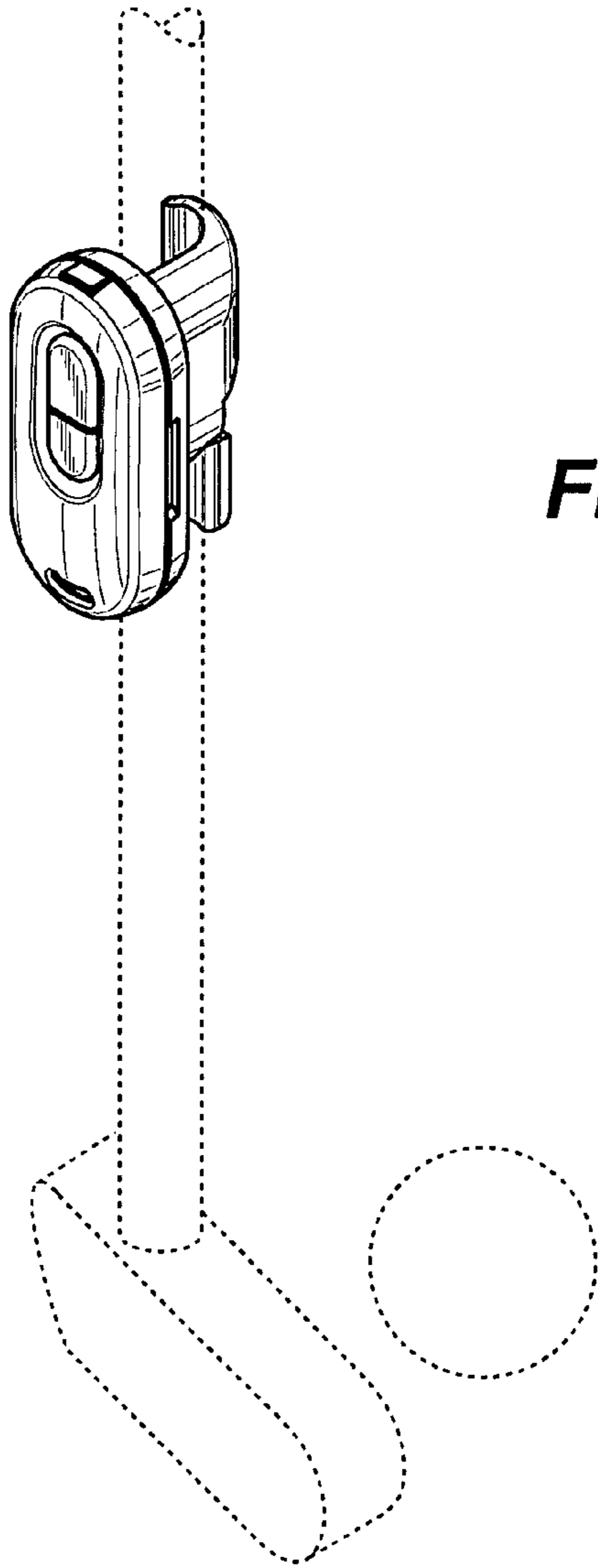
FIG. 12 is a top plan view of the clip; and,

FIG. 13 is bottom plan view of the clip.

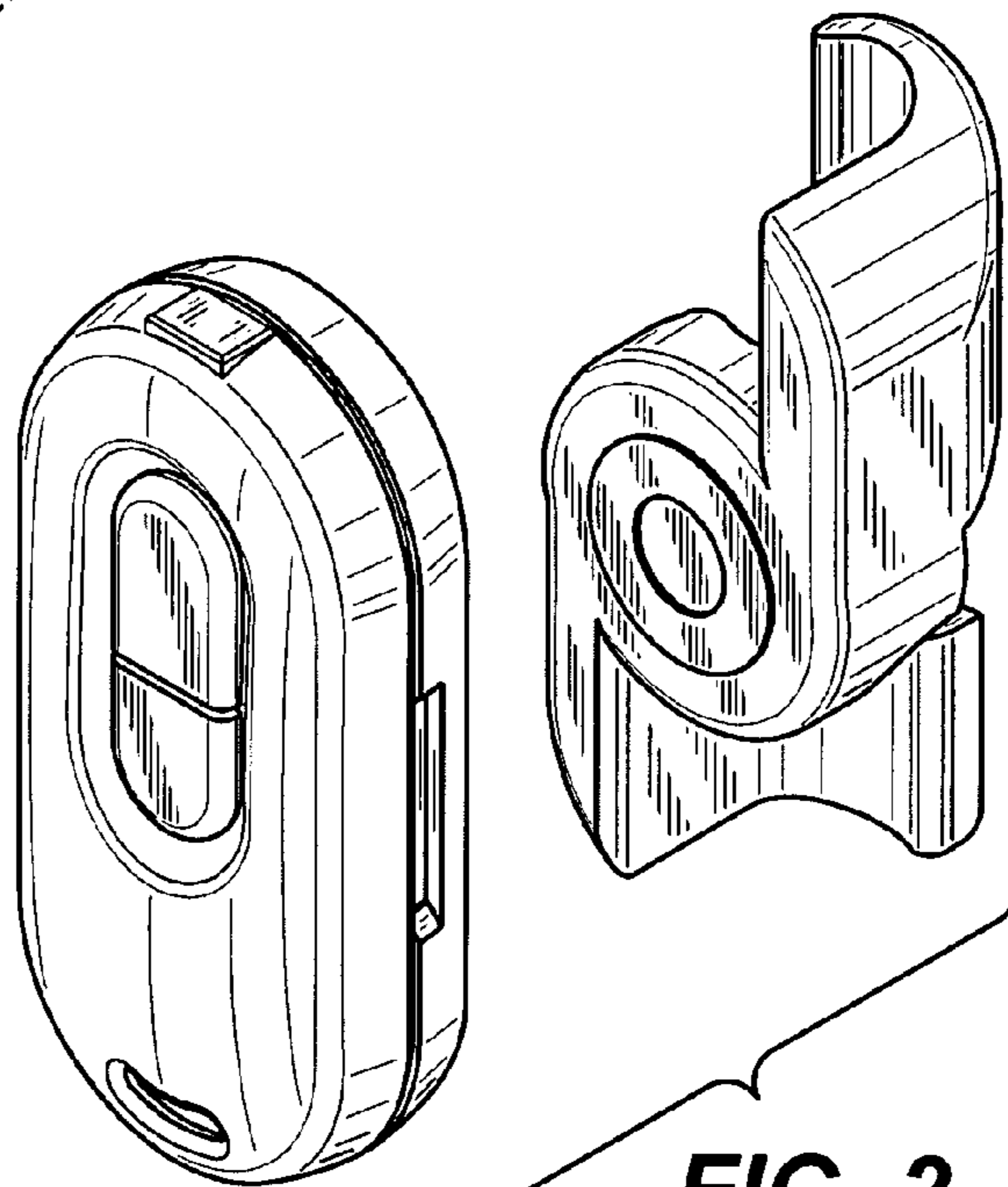
The golf club shaft, club head, and golf ball shown in broken  
lines in FIG. 1 are for illustrative purposes only, and form no  
part of the claimed design.

**1 Claim, 3 Drawing Sheets**

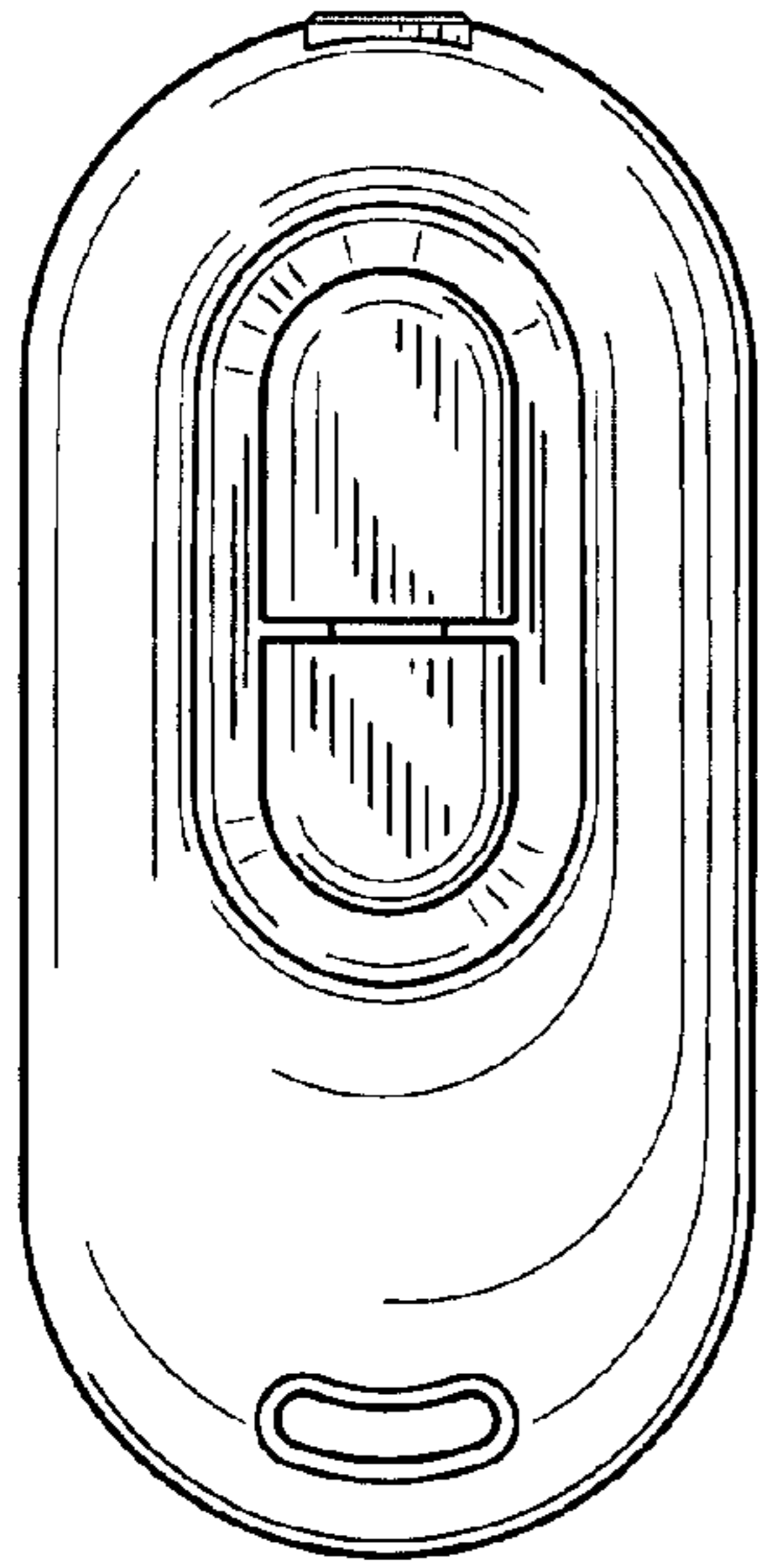




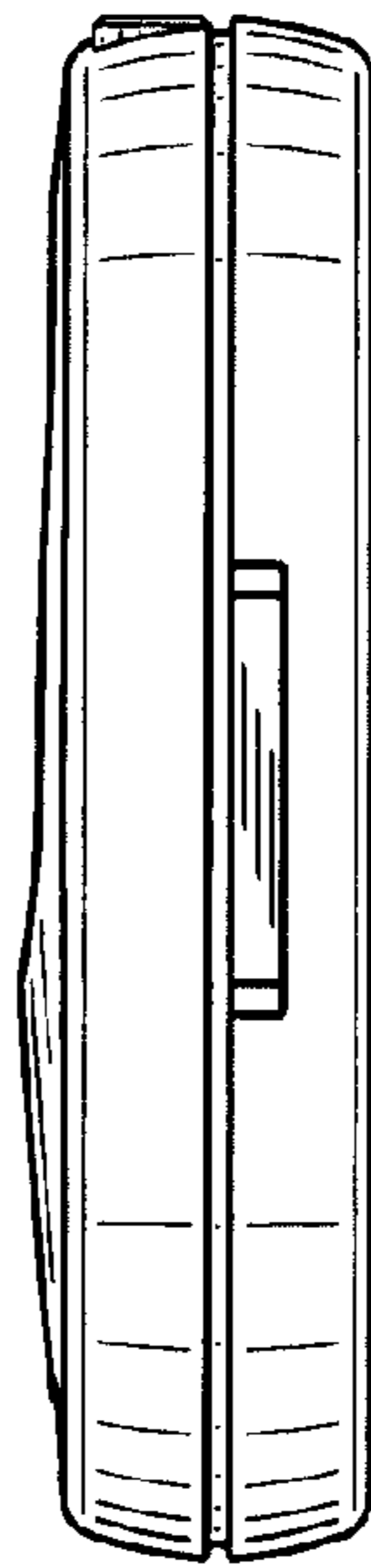
**FIG. 1**



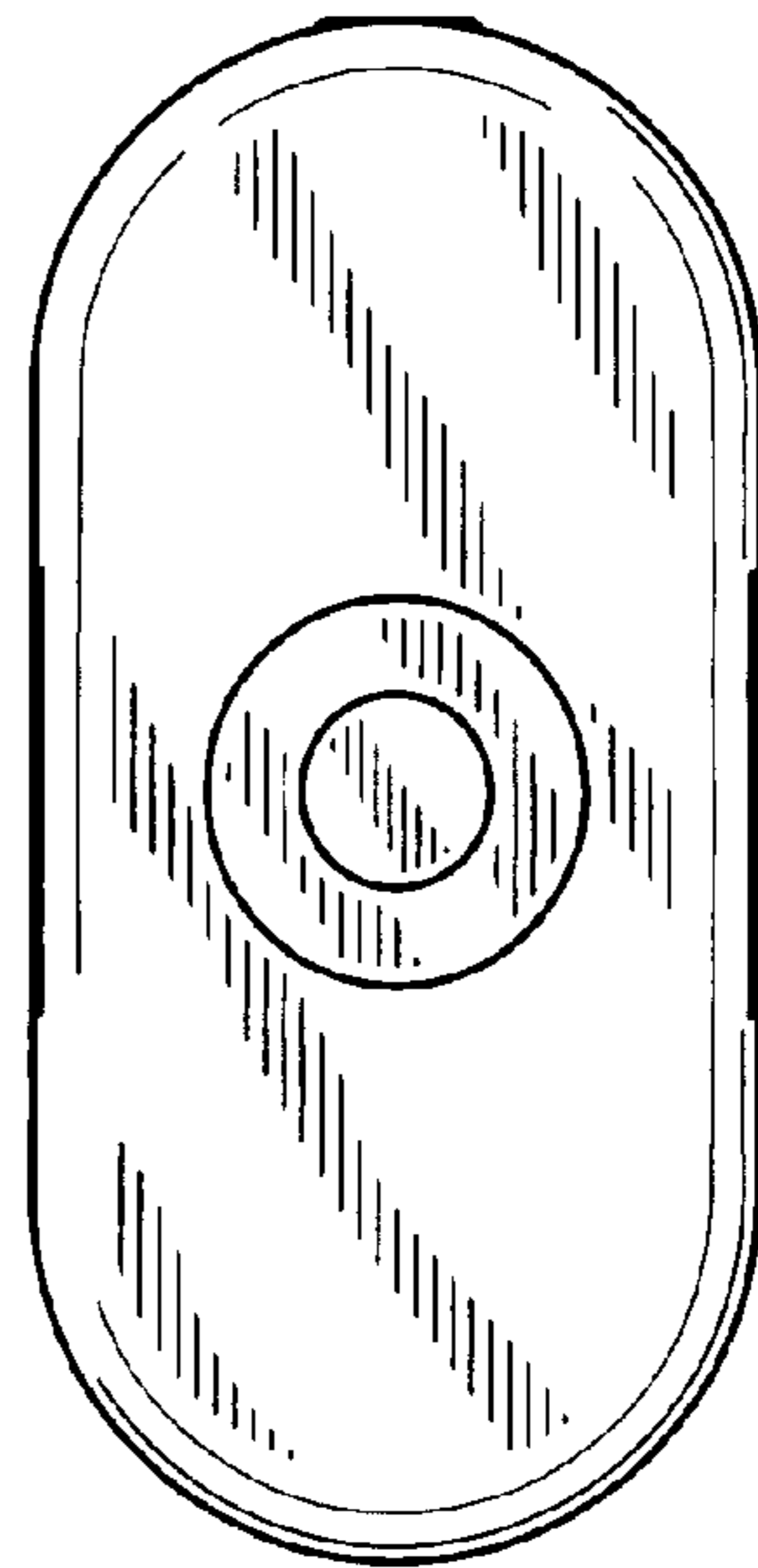
**FIG. 2**



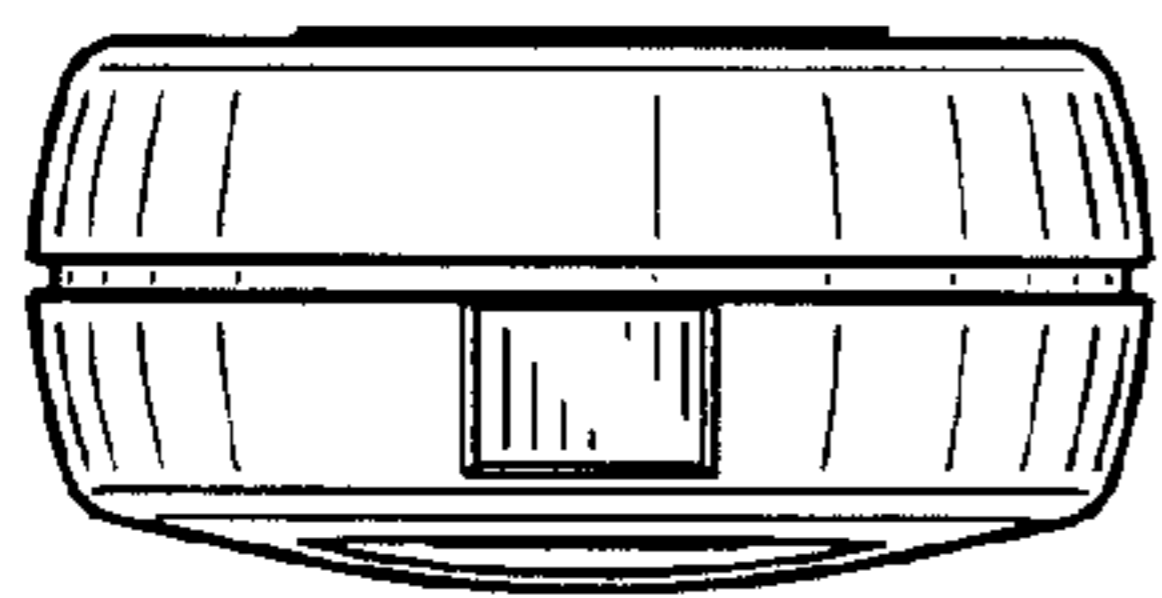
**FIG. 3**



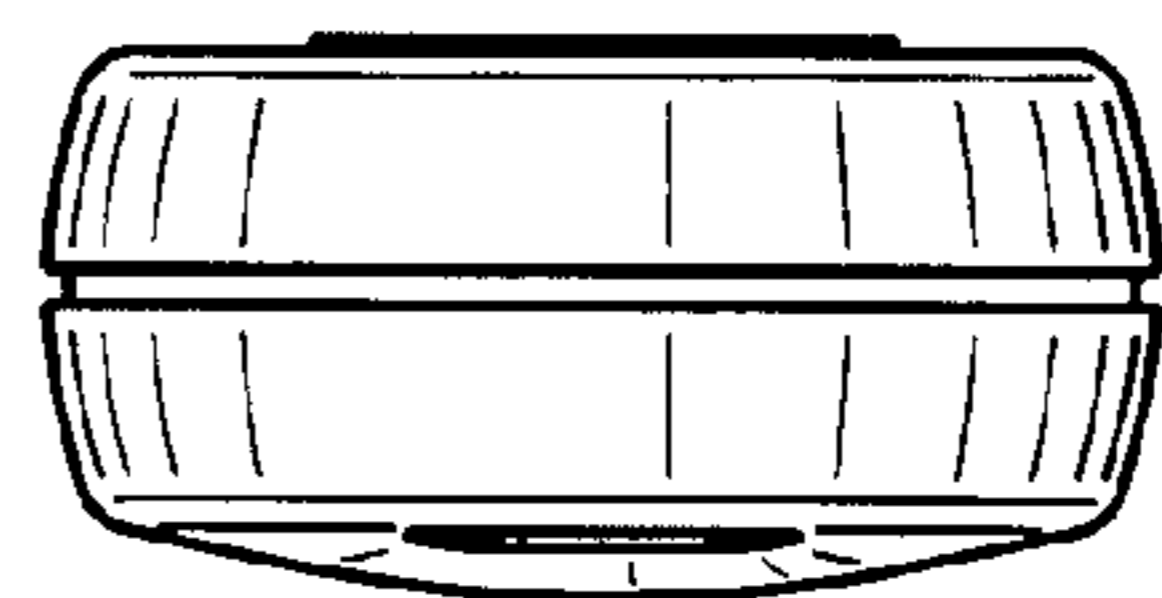
**FIG. 4**



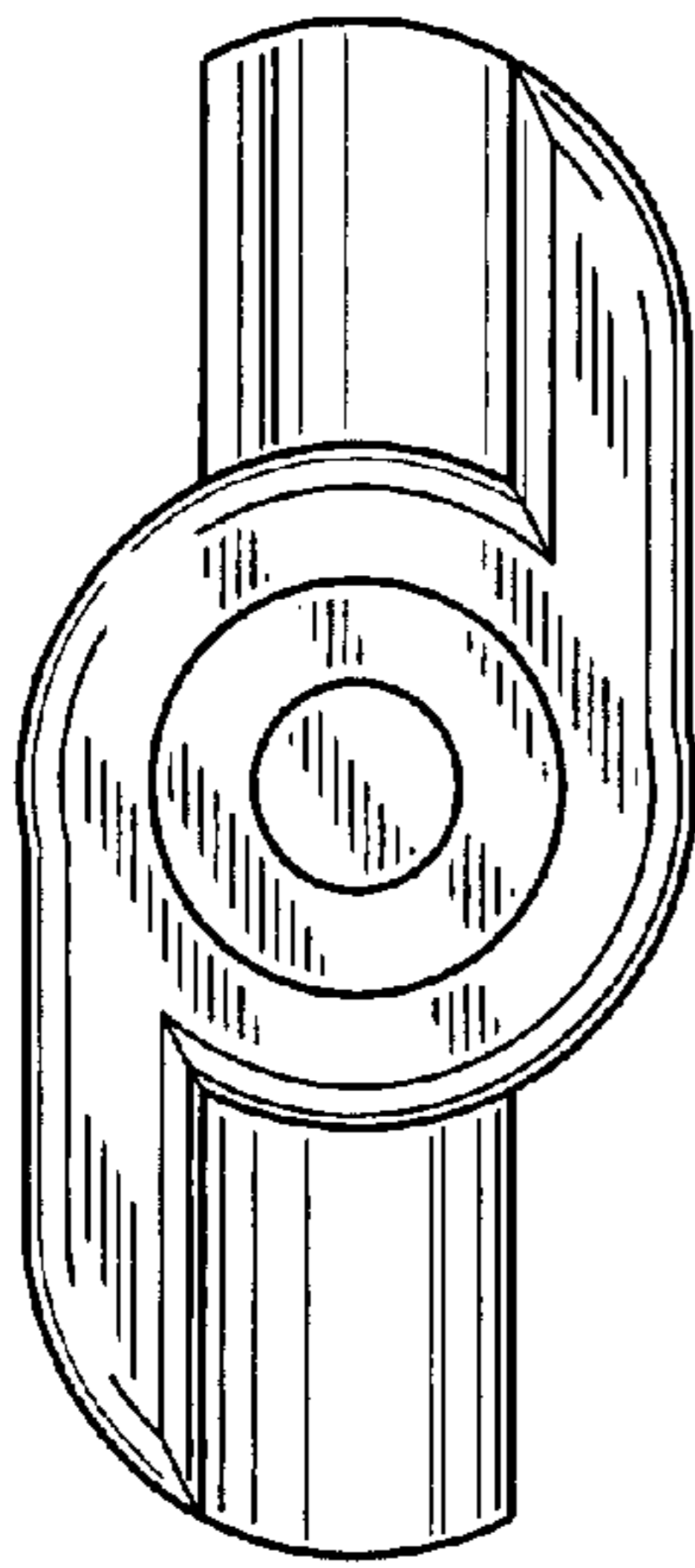
**FIG. 5**



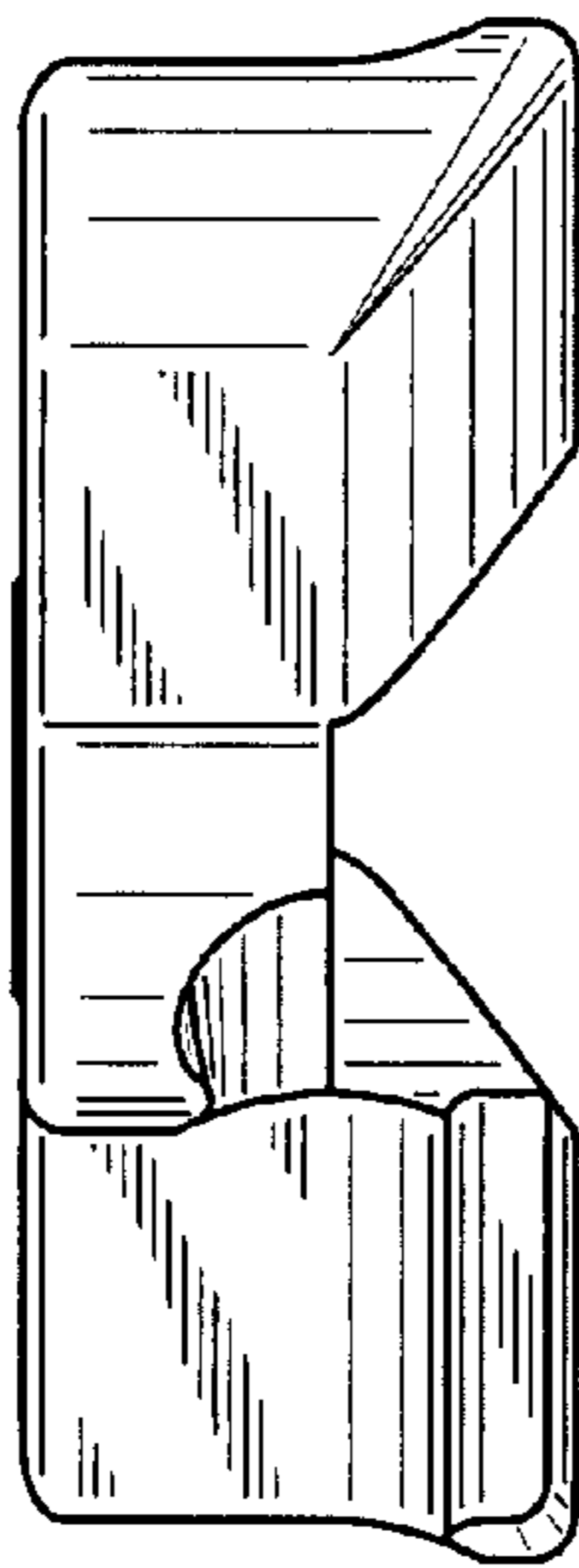
**FIG. 6**



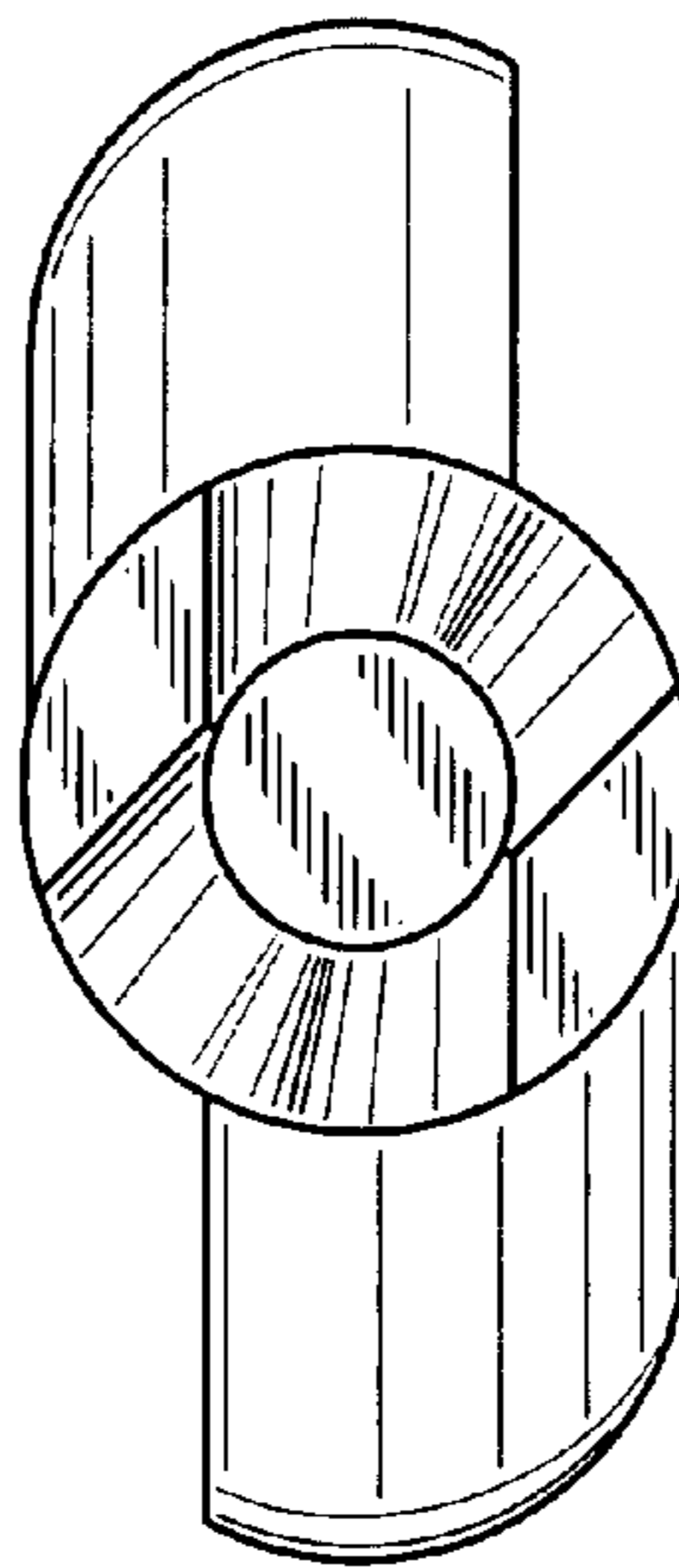
**FIG. 7**



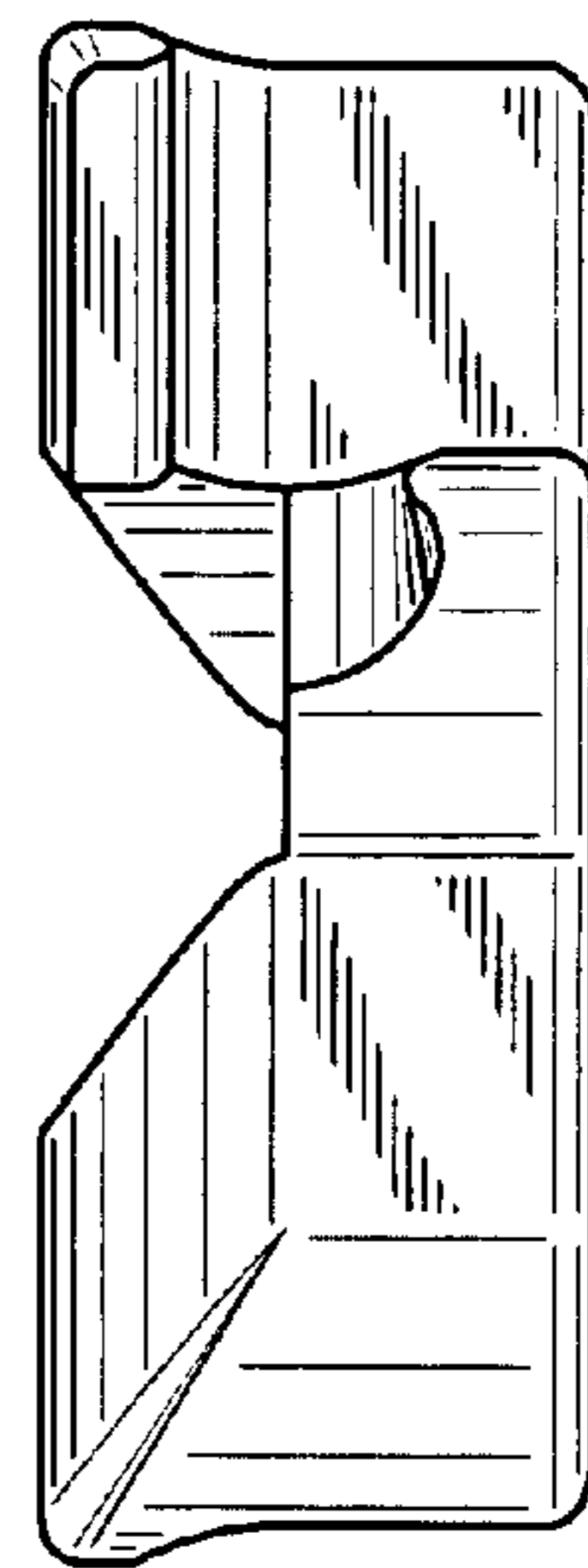
**FIG. 8**



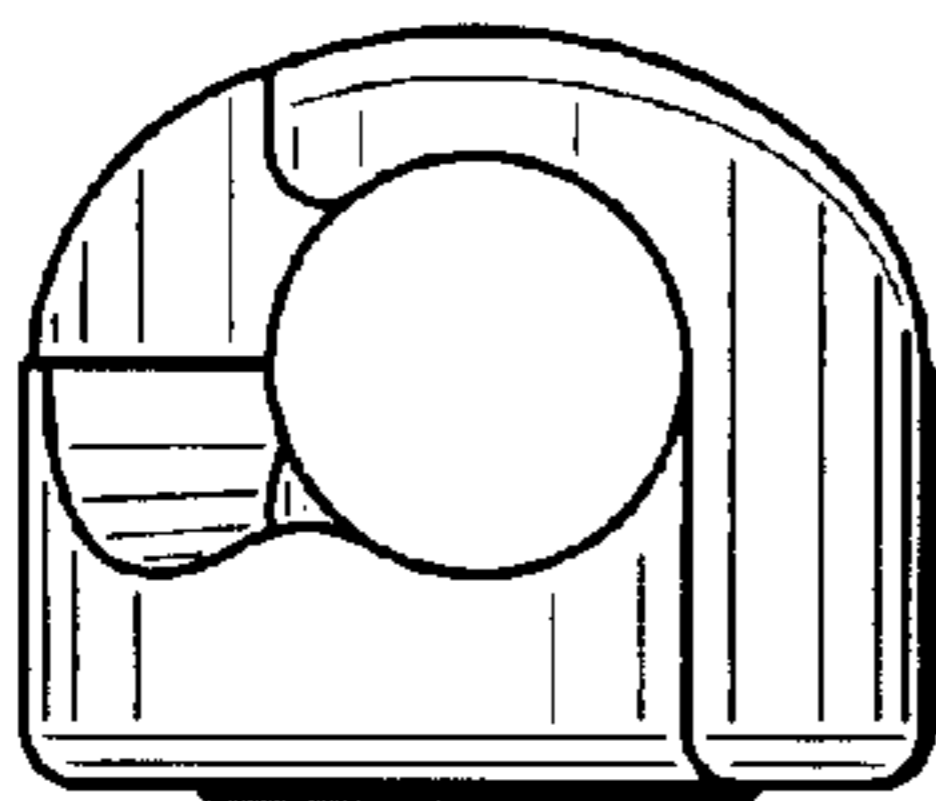
**FIG. 9**



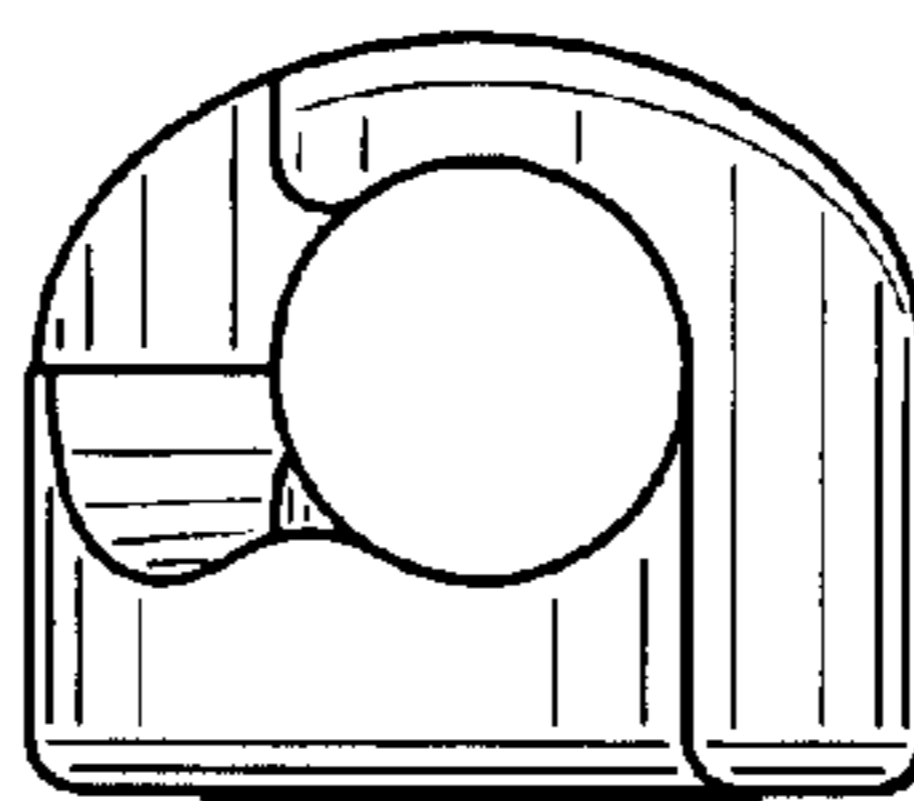
**FIG. 10**



**FIG. 11**



**FIG. 12**



**FIG. 13**