

US00D567759S

(12) **United States Design Patent**
Grad et al.

(10) **Patent No.:** **US D567,759 S**
(45) **Date of Patent:** **** Apr. 29, 2008**

(54) **TRANSFORMER WITH SET OF COMPONENTS**
(75) Inventors: **Josef Grad**, Neumarkt (DE); **Peter Heinzig**, Wendelstein (DE); **Klaus Müller**, Wendelstein (DE); **Uwe Rimmele**, Berlin (DE)

D202,045 S * 8/1965 Oberlin D13/110
3,479,563 A * 11/1969 Roy 361/41
4,027,279 A * 5/1977 Shigehara 336/90
D259,040 S * 4/1981 Pierce D13/110
D294,565 S * 3/1988 Makinson et al. D13/110
D348,868 S * 7/1994 Terlop et al. D13/110
6,185,811 B1 * 2/2001 Perry 29/606

(73) Assignee: **Siemens Aktiengesellschaft**, Munich (DE)

* cited by examiner

(**) Term: **14 Years**

Primary Examiner—Prabhakar Deshmukh
Assistant Examiner—Derrick Holland

(21) Appl. No.: **29/286,392**

(74) *Attorney, Agent, or Firm*—Laurence A. Greenberg; Werner H. Stemer; Ralph E. Locher

(22) Filed: **May 3, 2007**

(57) **CLAIM**

(30) **Foreign Application Priority Data**

The ornamental design for a transformer with set of components, as shown and described.

Nov. 3, 2006 (EM) 000621370

DESCRIPTION

(51) **LOC (8) Cl.** **13-02**

FIG. 1 is a front elevational view of a transformer with set of components showing our new design;

(52) **U.S. Cl.** **D13/110**

FIG. 2 is a rear elevational view thereof;

(58) **Field of Classification Search** D13/110,
D13/101, 199; 174/52 R; 220/4.02; 336/92,
336/94, 98, 107; 363/153, 171
See application file for complete search history.

FIG. 3 is a top plan view thereof;

FIG. 4 is a bottom plan view thereof;

FIG. 5 is right-side elevational view thereof;

FIG. 6 is left-side elevational view thereof; and,

FIG. 7 is a front, top perspective view thereof.

(56) **References Cited**

U.S. PATENT DOCUMENTS

D188,248 S * 6/1960 Bianco et al. D13/110
D188,249 S * 6/1960 Bianco et al. D13/110

1 Claim, 7 Drawing Sheets

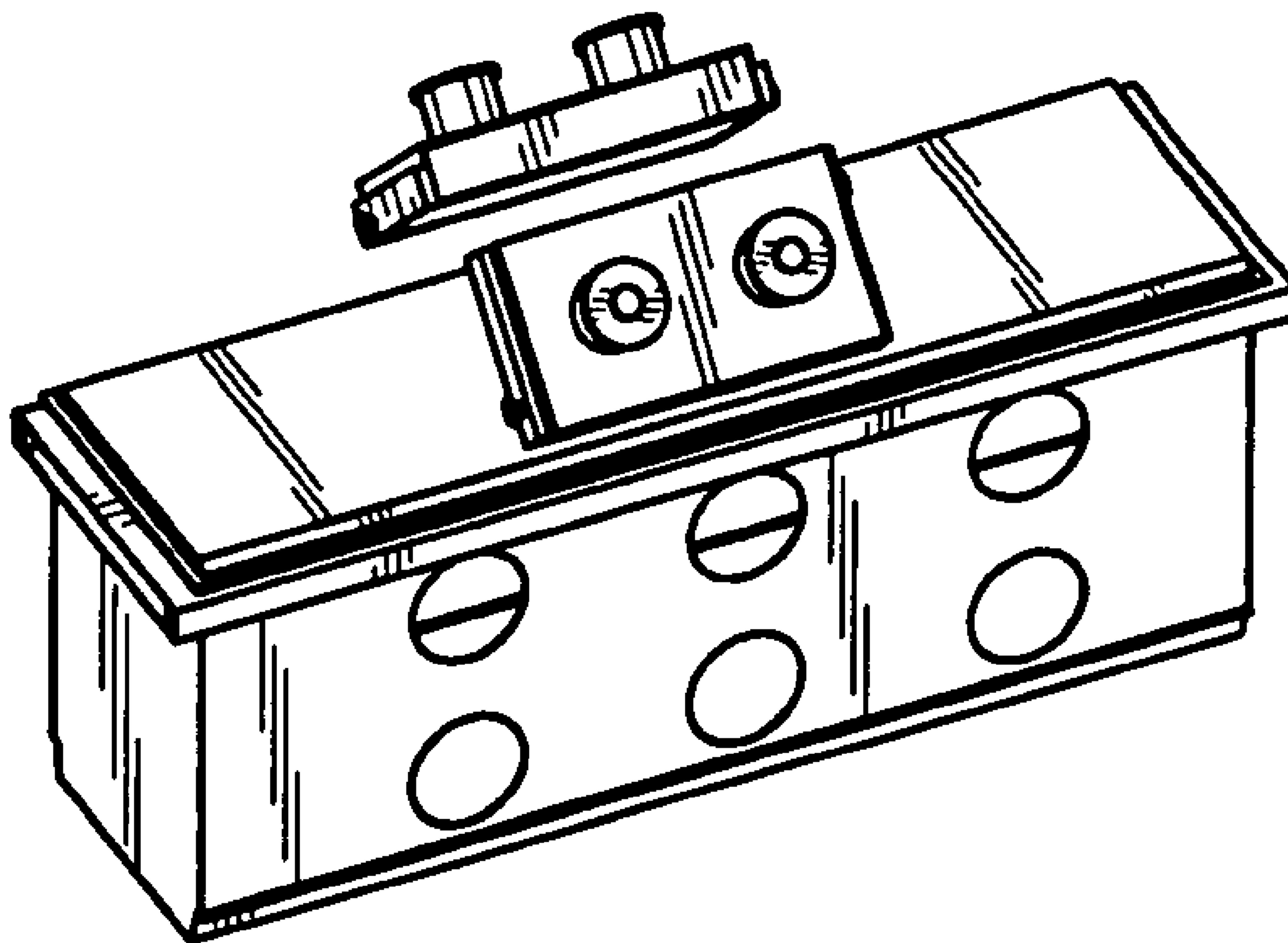

FIG. 1

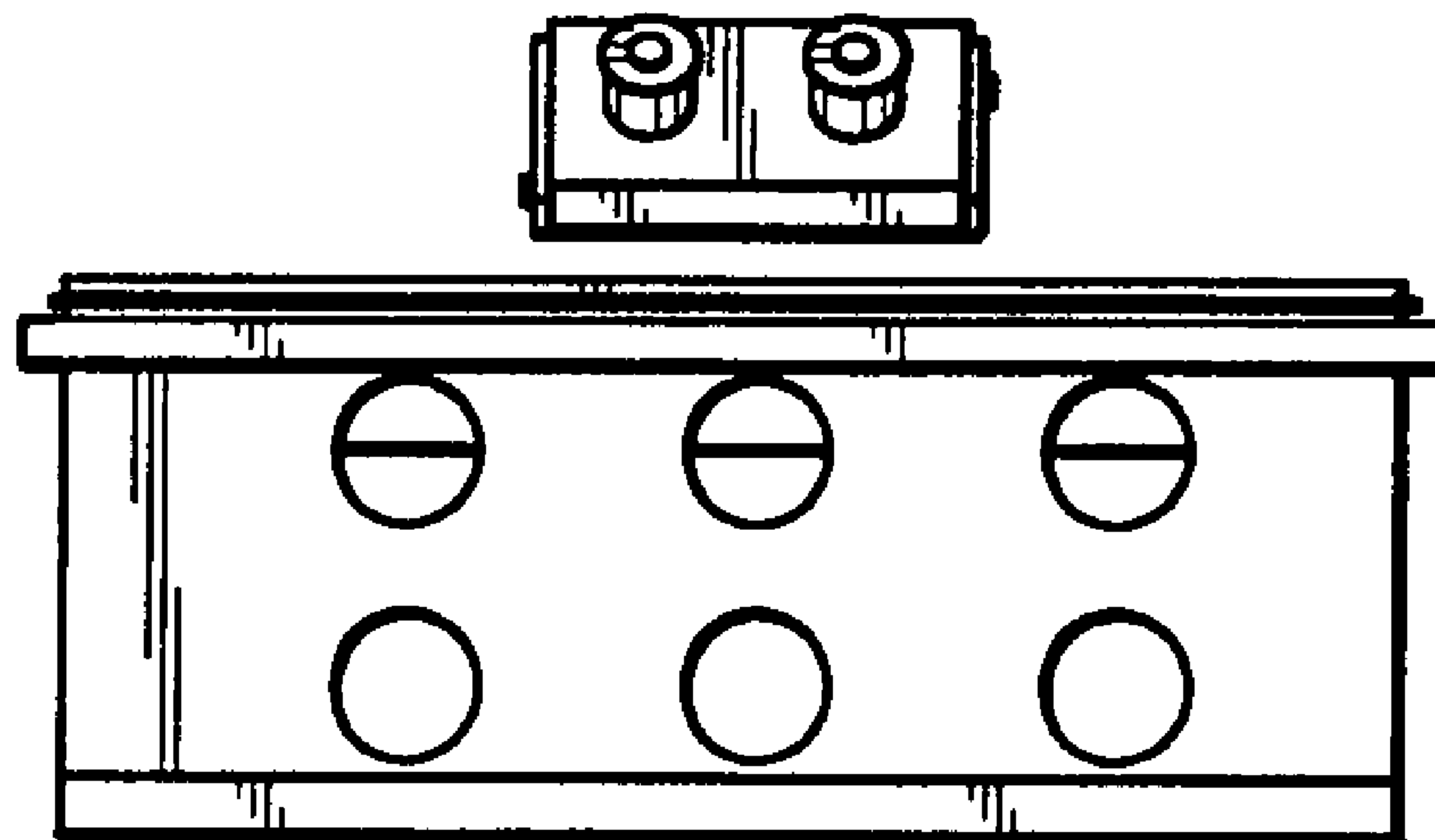

FIG.2

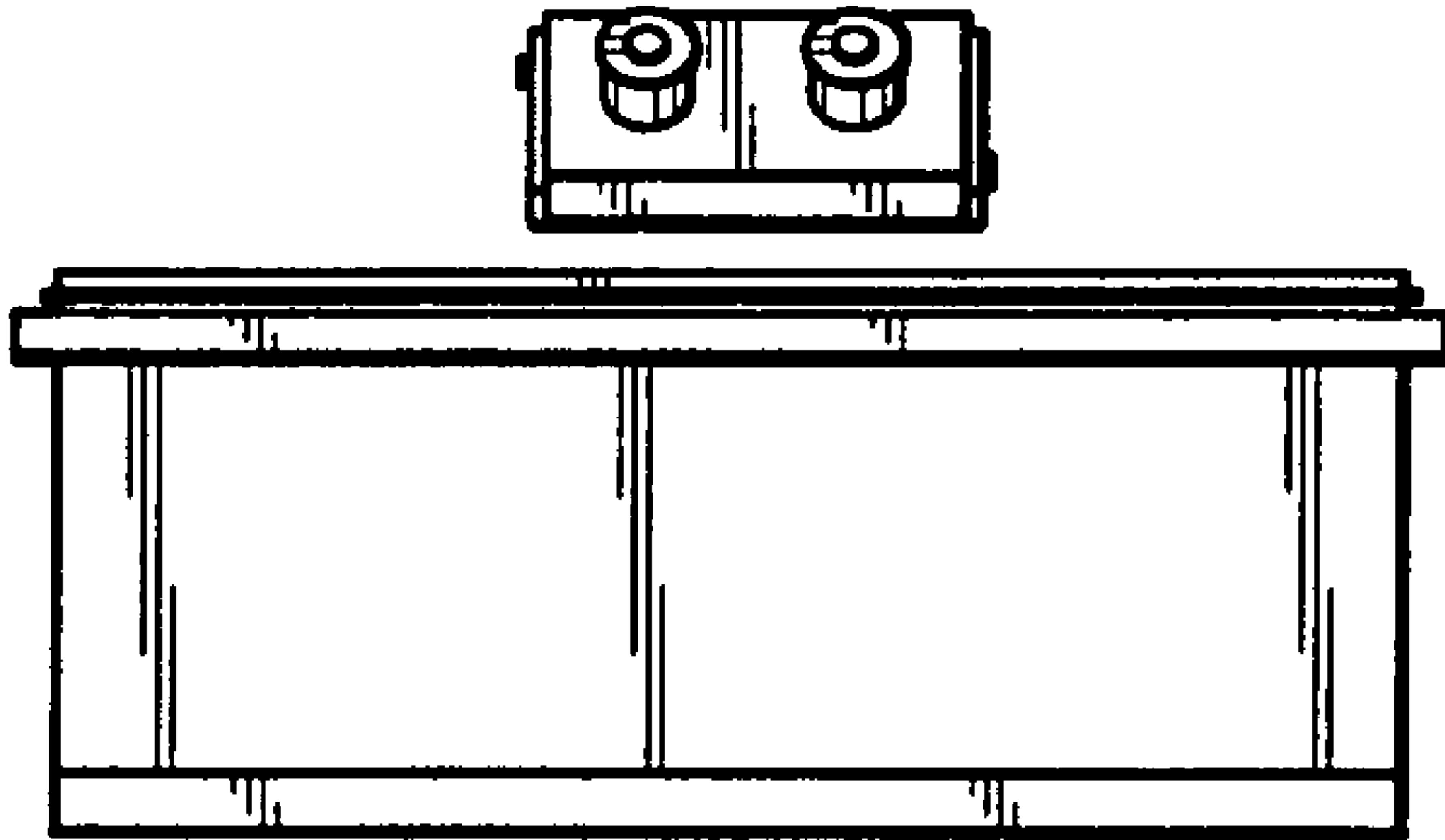

FIG.3

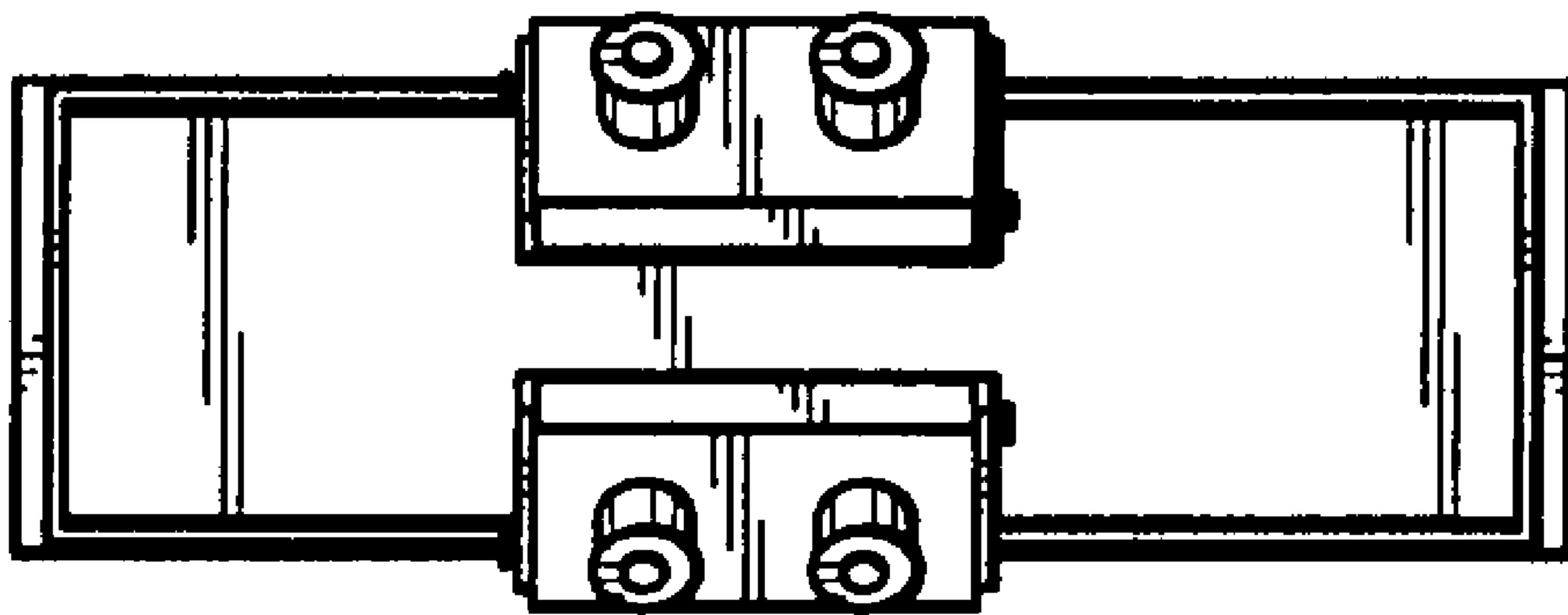

FIG.4

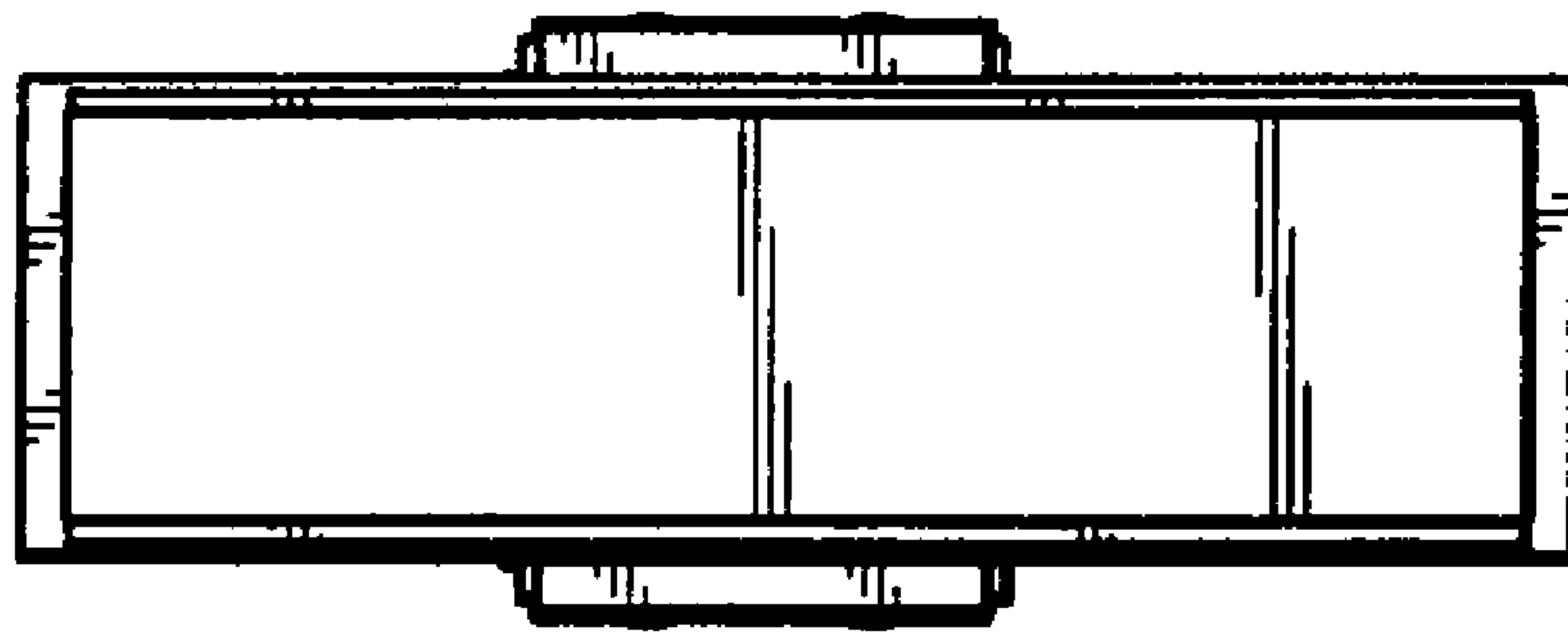

FIG. 5

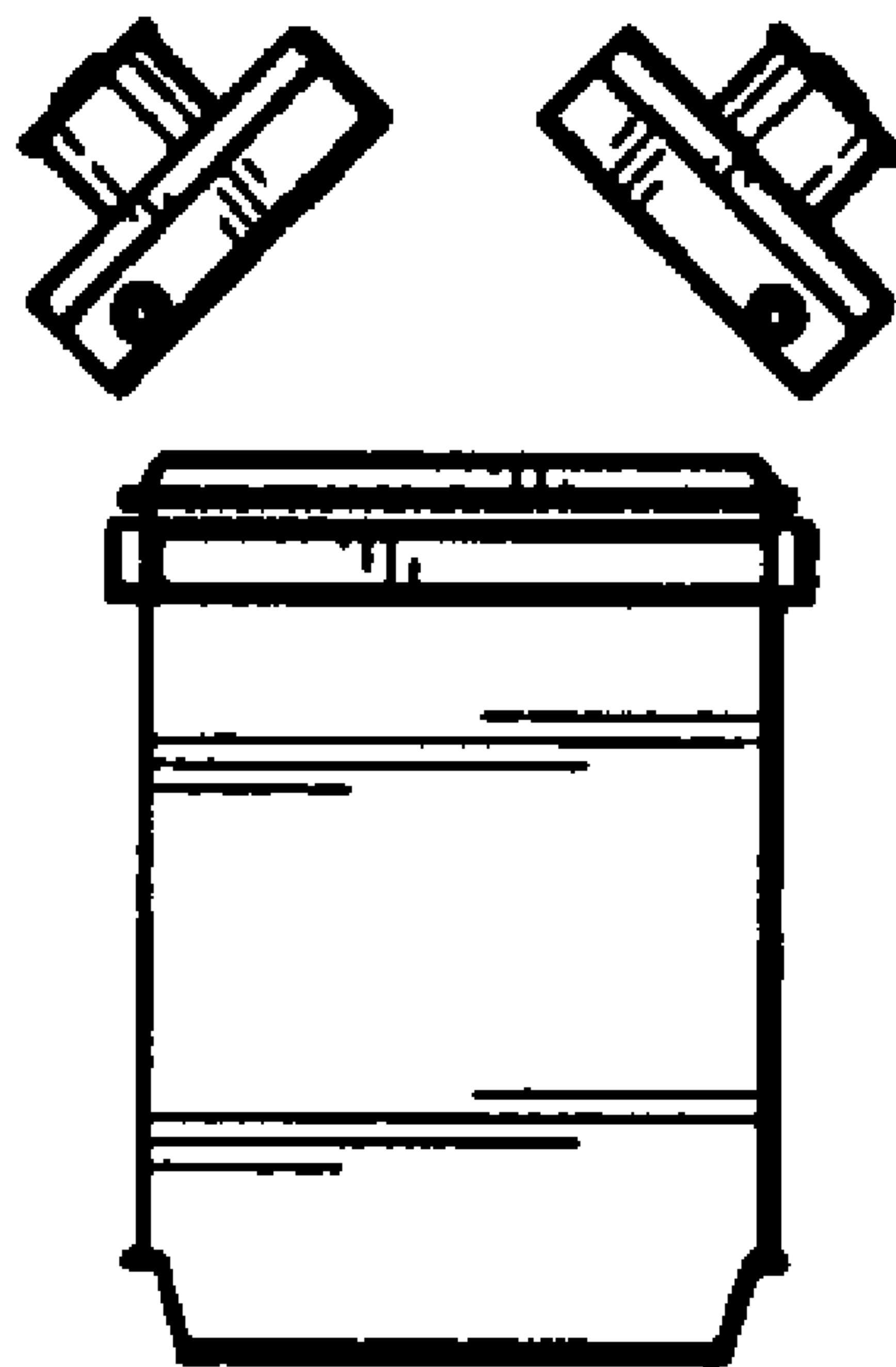

FIG. 6

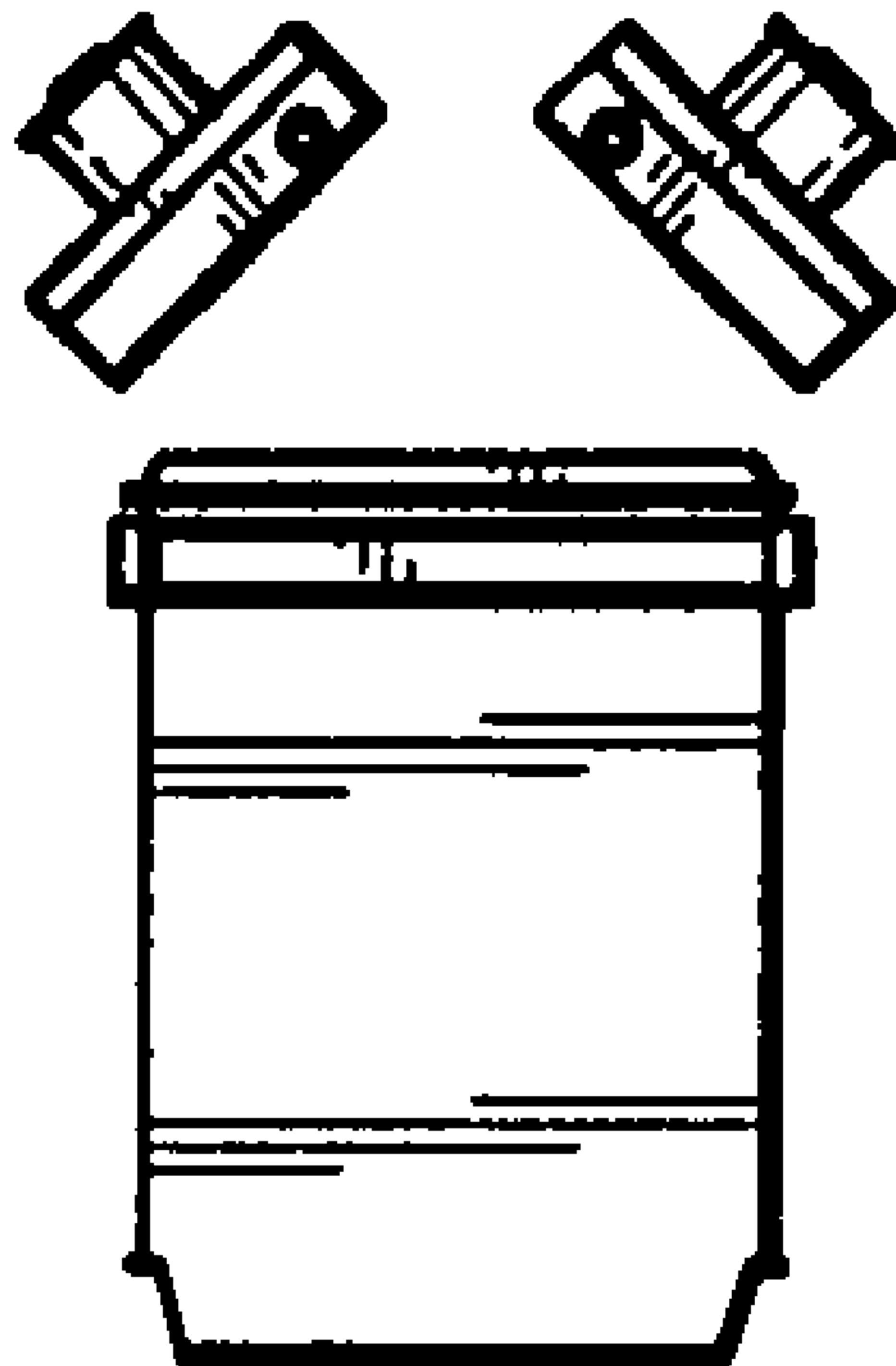

FIG.7

