

US00D567707S

(12) **United States Design Patent**
Yeates et al.

(10) **Patent No.:** **US D567,707 S**
(45) **Date of Patent:** **** Apr. 29, 2008**

(54) **BELT LOOP**

(75) Inventors: **Eric M. Yeates**, Virginia Beach, VA (US); **Charles E. Buis, III**, Virginia Beach, VA (US); **Thomas M. Gregory**, Belgrade, MT (US); **Robert A. Kincaid**, Bozeman, MT (US)

(73) Assignee: **Blackhawk Industries Product Group Unlimited LLC**, Norfolk, VA (US)

(**) Term: **14 Years**

(21) Appl. No.: **29/253,584**

(22) Filed: **Feb. 8, 2006**

(51) **LOC (8) Cl.** **02-07**

(52) **U.S. Cl.** **D11/200**

(58) **Field of Classification Search** D11/200,
D11/201, 216, 217, 218, 219; D2/639; D8/383;
24/3.12, 169, 182, 579.11, 631, 633, 641,
24/651, 652; 224/192, 195, 197, 198, 673;
297/483, 485

See application file for complete search history.

(56) **References Cited**

U.S. PATENT DOCUMENTS

5,377,393 A * 1/1995 Ellis 24/641
6,010,045 A * 1/2000 Rogers et al. 224/198
6,588,640 B1 * 7/2003 Rogers et al. 224/673

D519,056 S * 4/2006 Yoshiguchi D11/200
7,320,420 B2 * 1/2008 Buis et al. 224/197
2005/0178808 A1 * 8/2005 Buis et al. 224/198

* cited by examiner

Primary Examiner—Louis S Zarfaz

Assistant Examiner—Monica A Weingart

(74) *Attorney, Agent, or Firm*—Bowman Green Hampton & Kelly, PLLC

(57) **CLAIM**

The ornamental design for a belt loop, as shown and described.

DESCRIPTION

FIG. 1 is a front perspective view of a belt loop showing our new design;

FIG. 2 is a rear perspective view thereof;

FIG. 3 is a front elevational view thereof;

FIG. 4 is a rear elevational view thereof;

FIG. 5 is right side elevational view thereof;

FIG. 6 is a top plan view thereof;

FIG. 7 is a bottom plan view thereof; and,

FIG. 8 is a front elevational view of a second embodiment thereof.

1 Claim, 4 Drawing Sheets

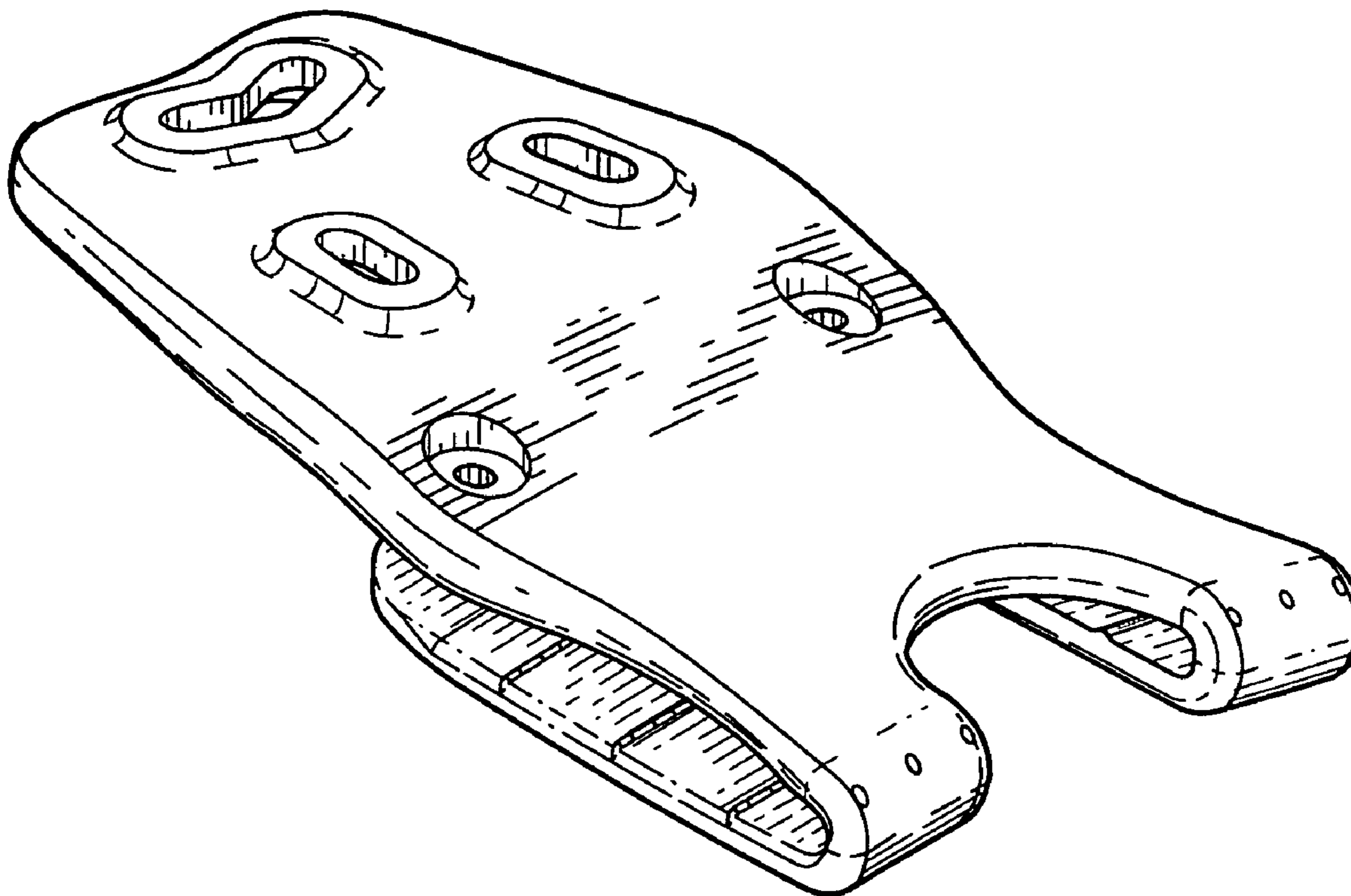

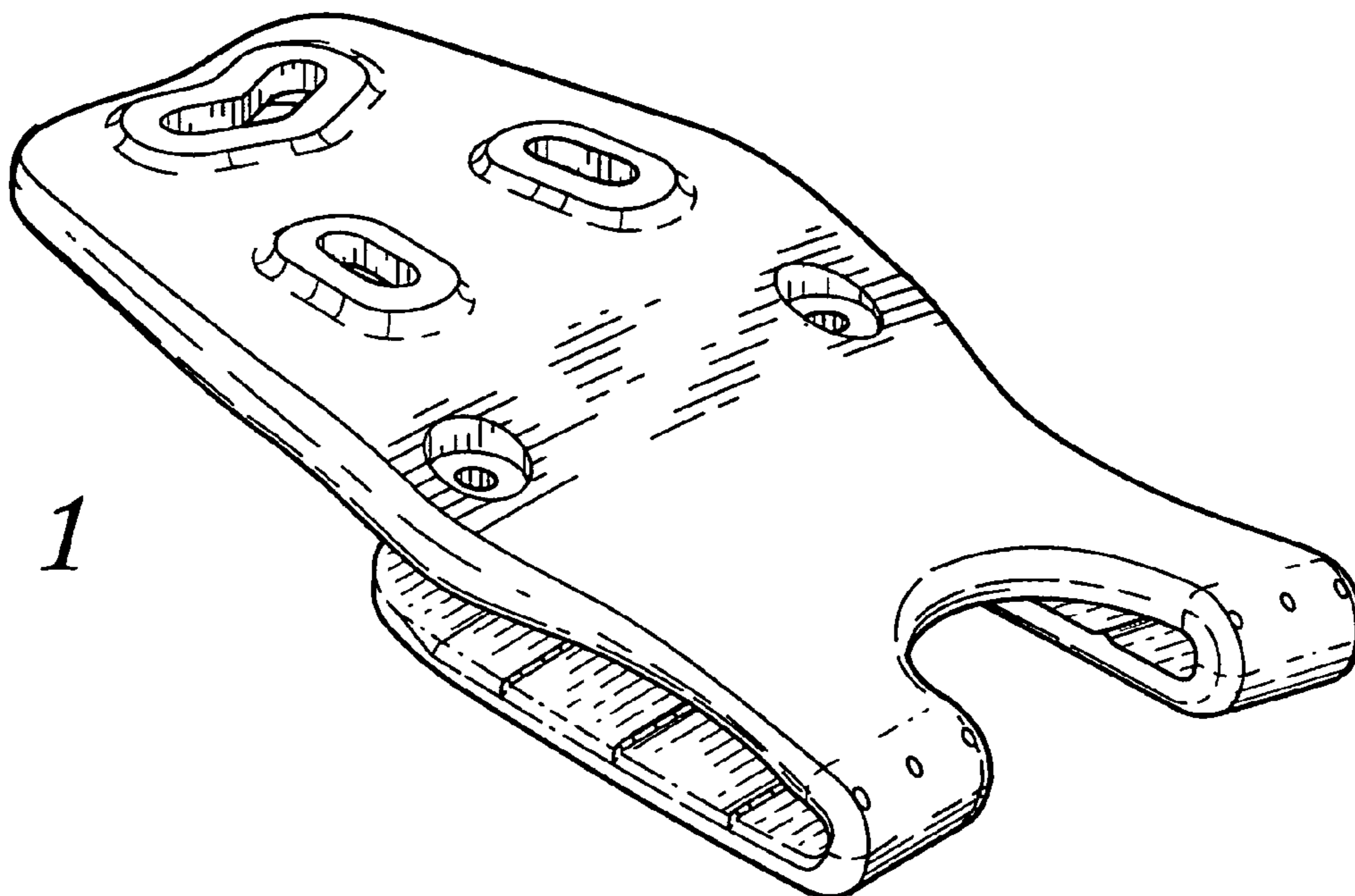

Fig. 1

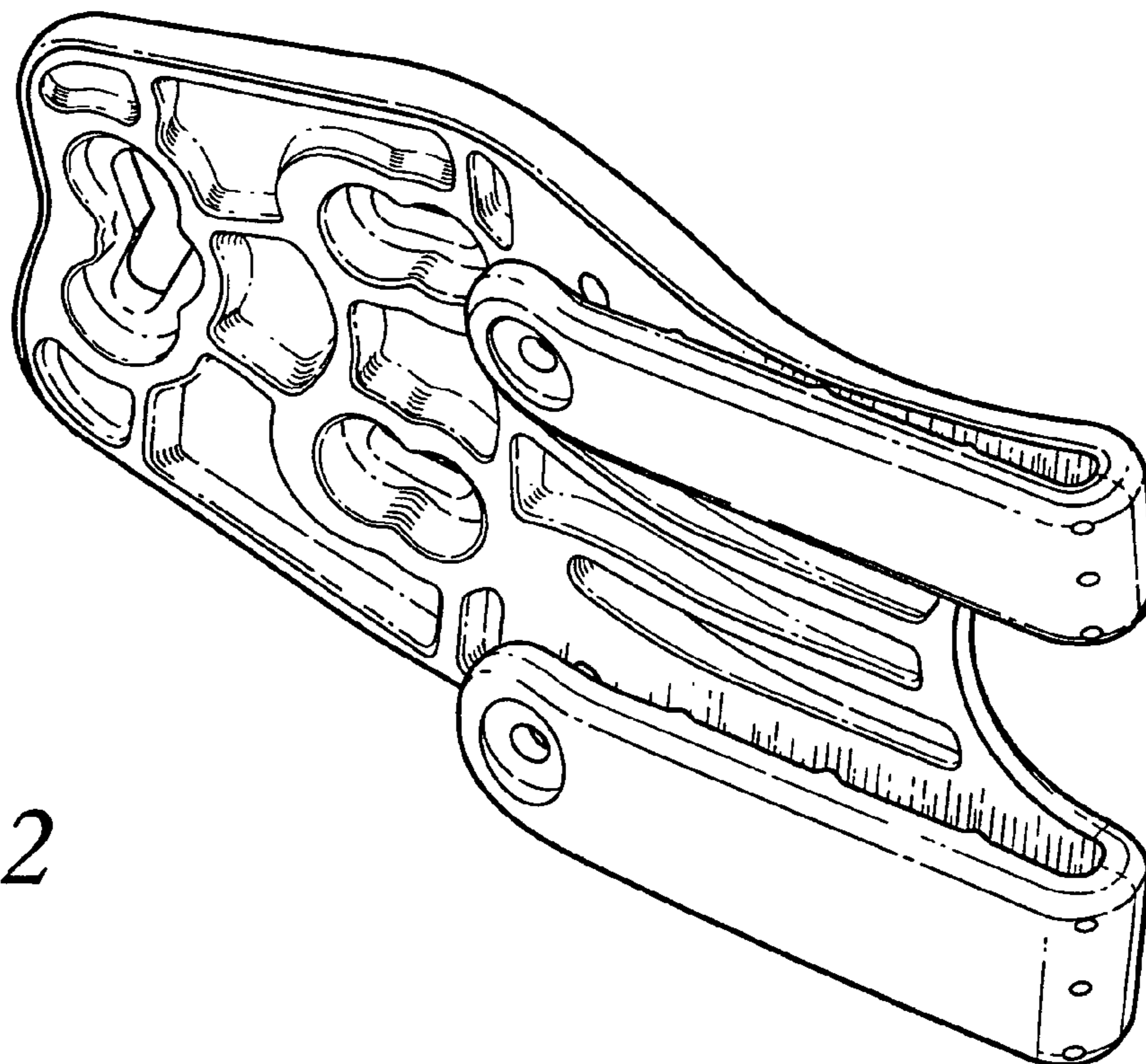

Fig. 2

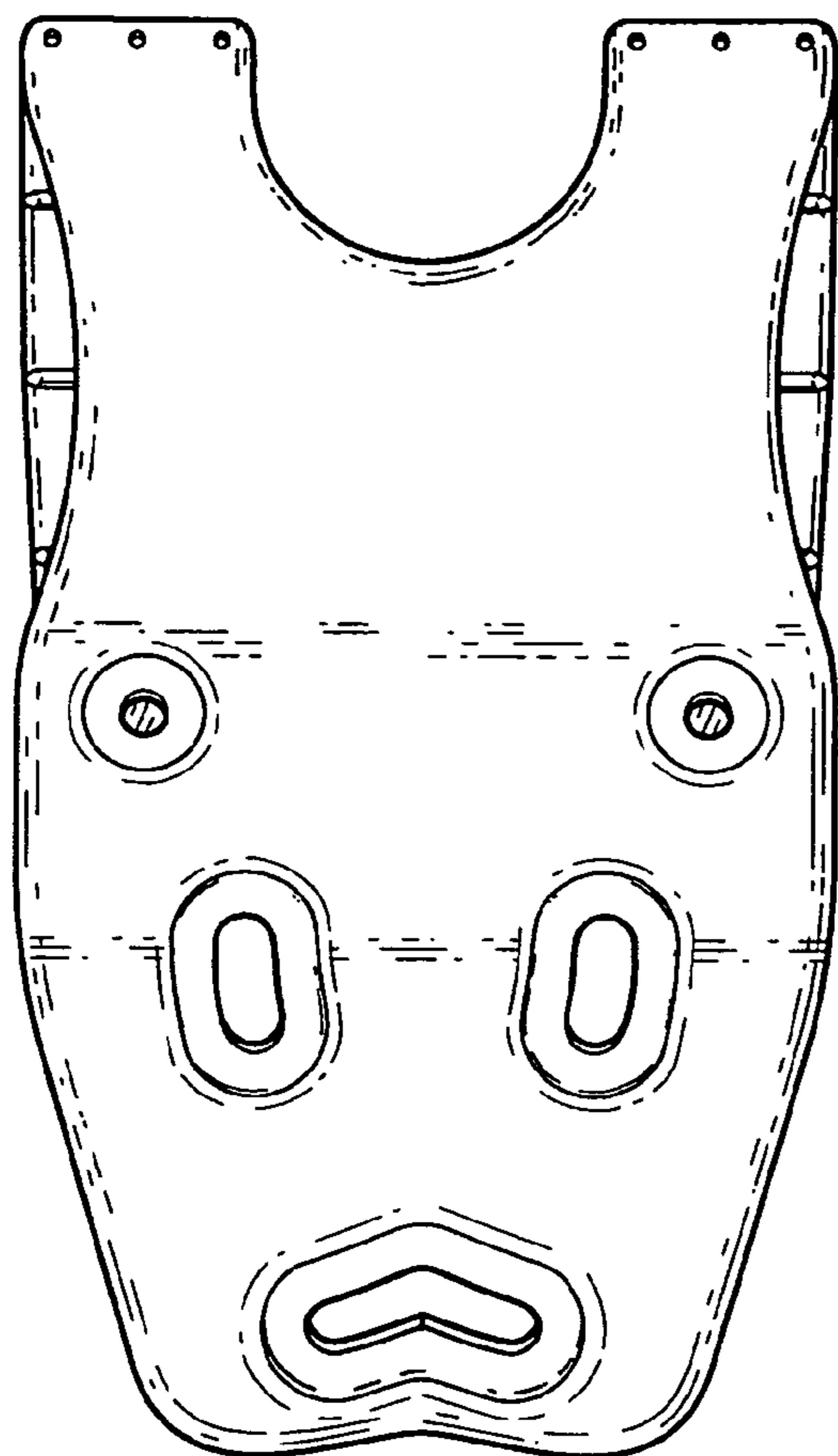

Fig. 3

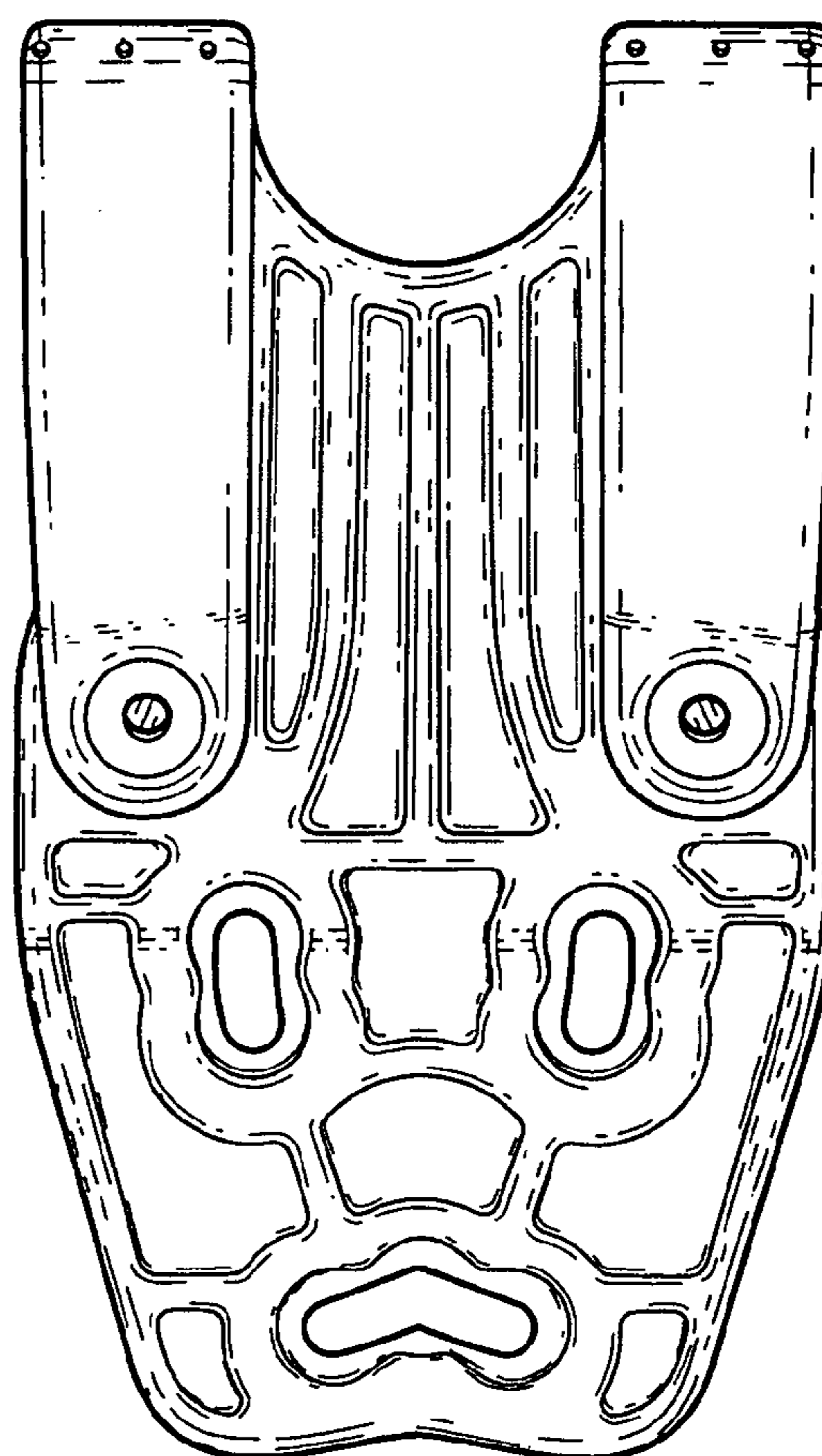

Fig. 4

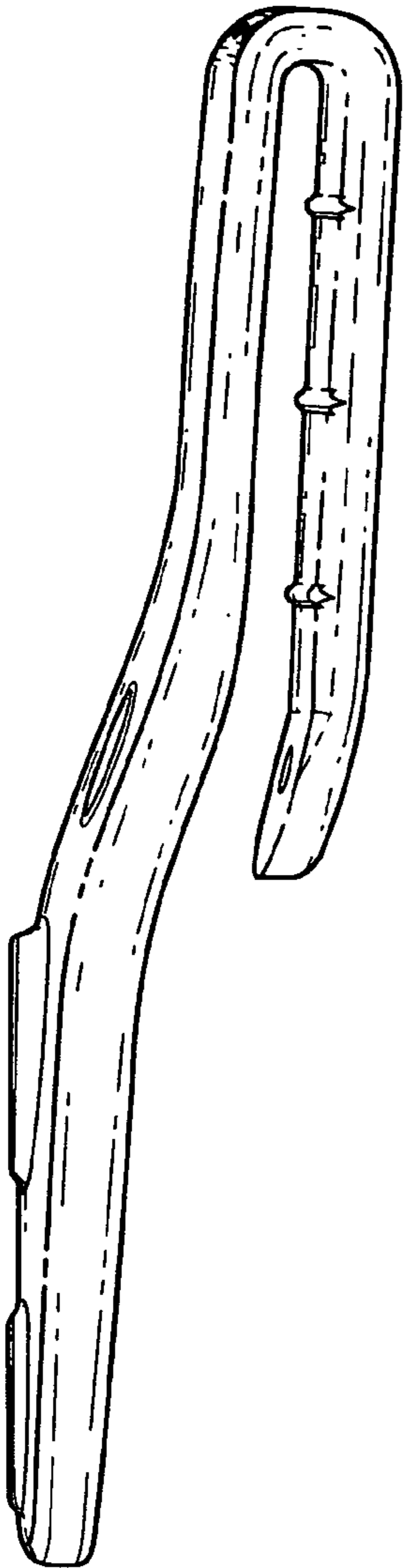

Fig. 5

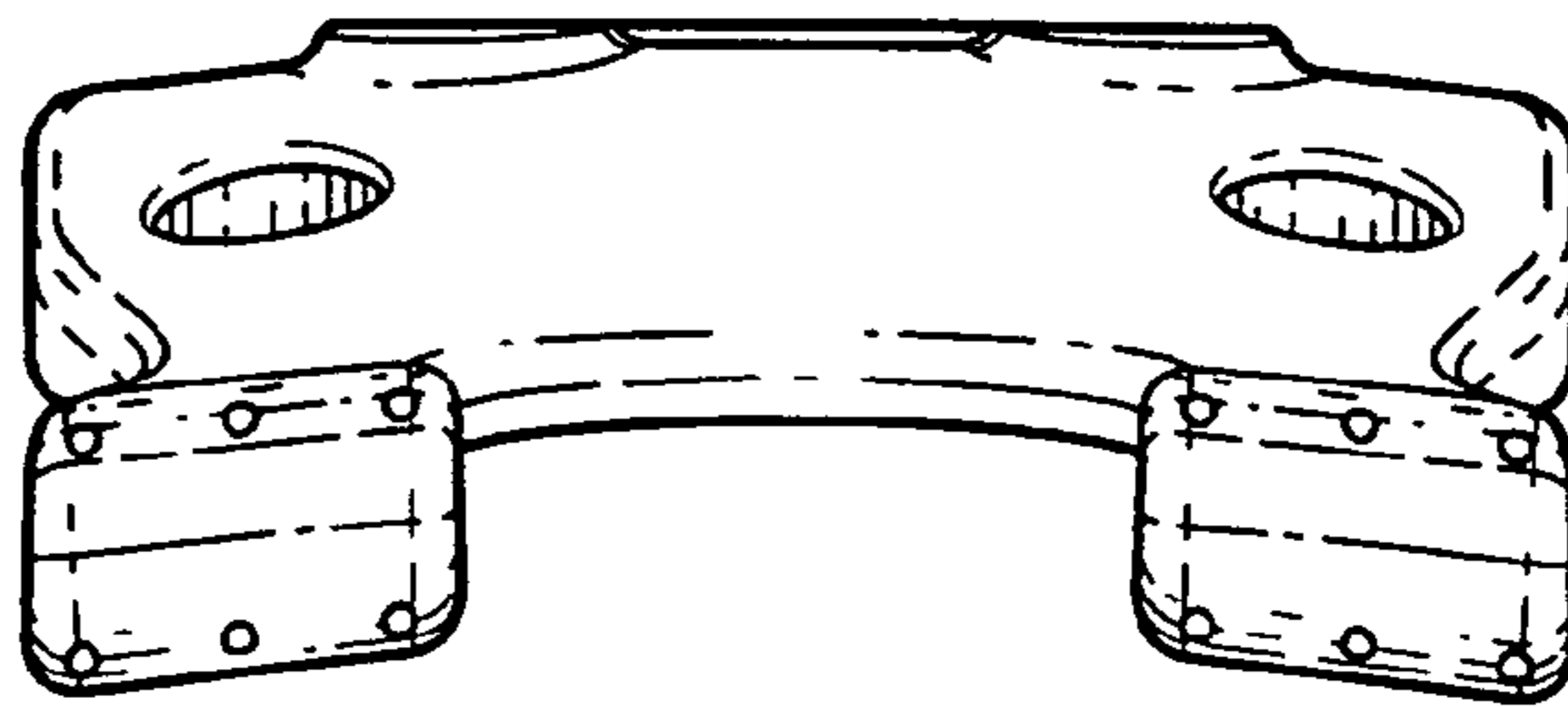

Fig. 6

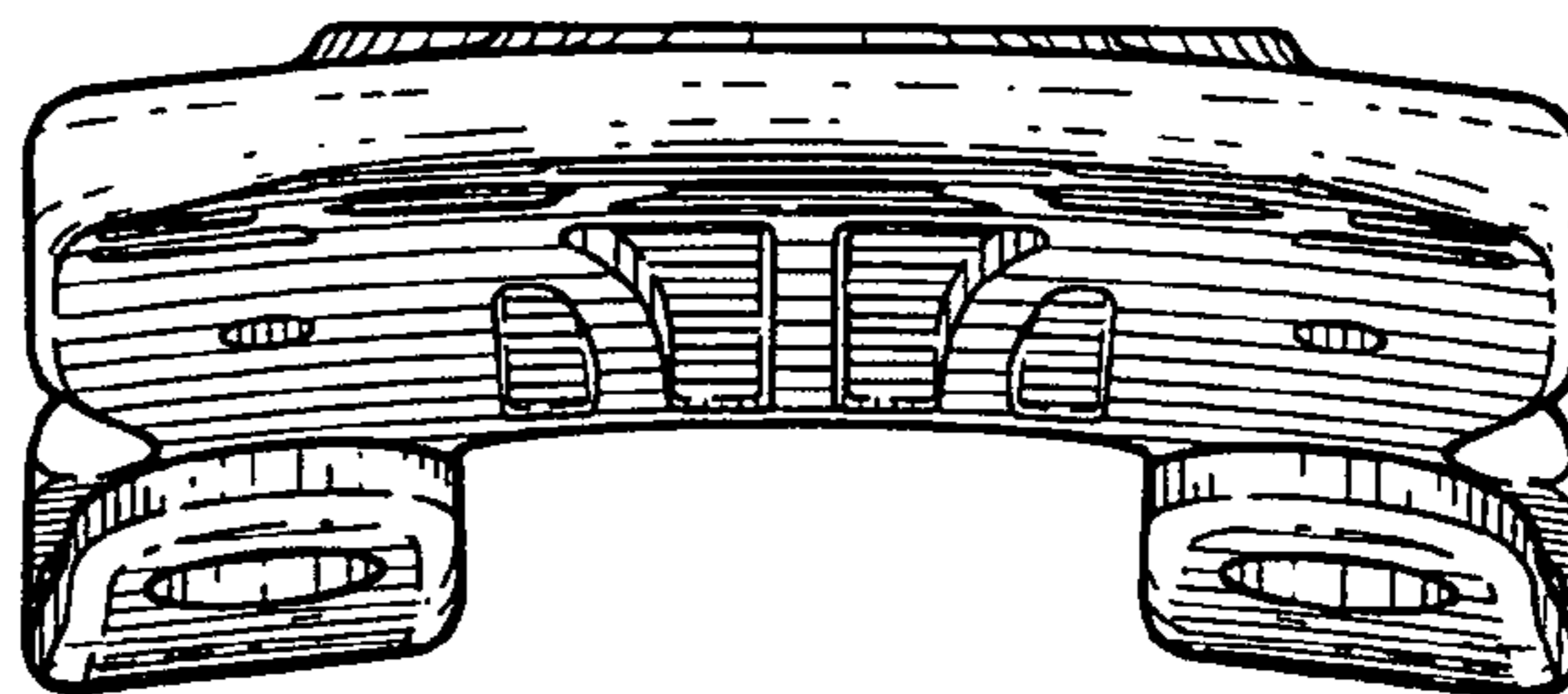

Fig. 7

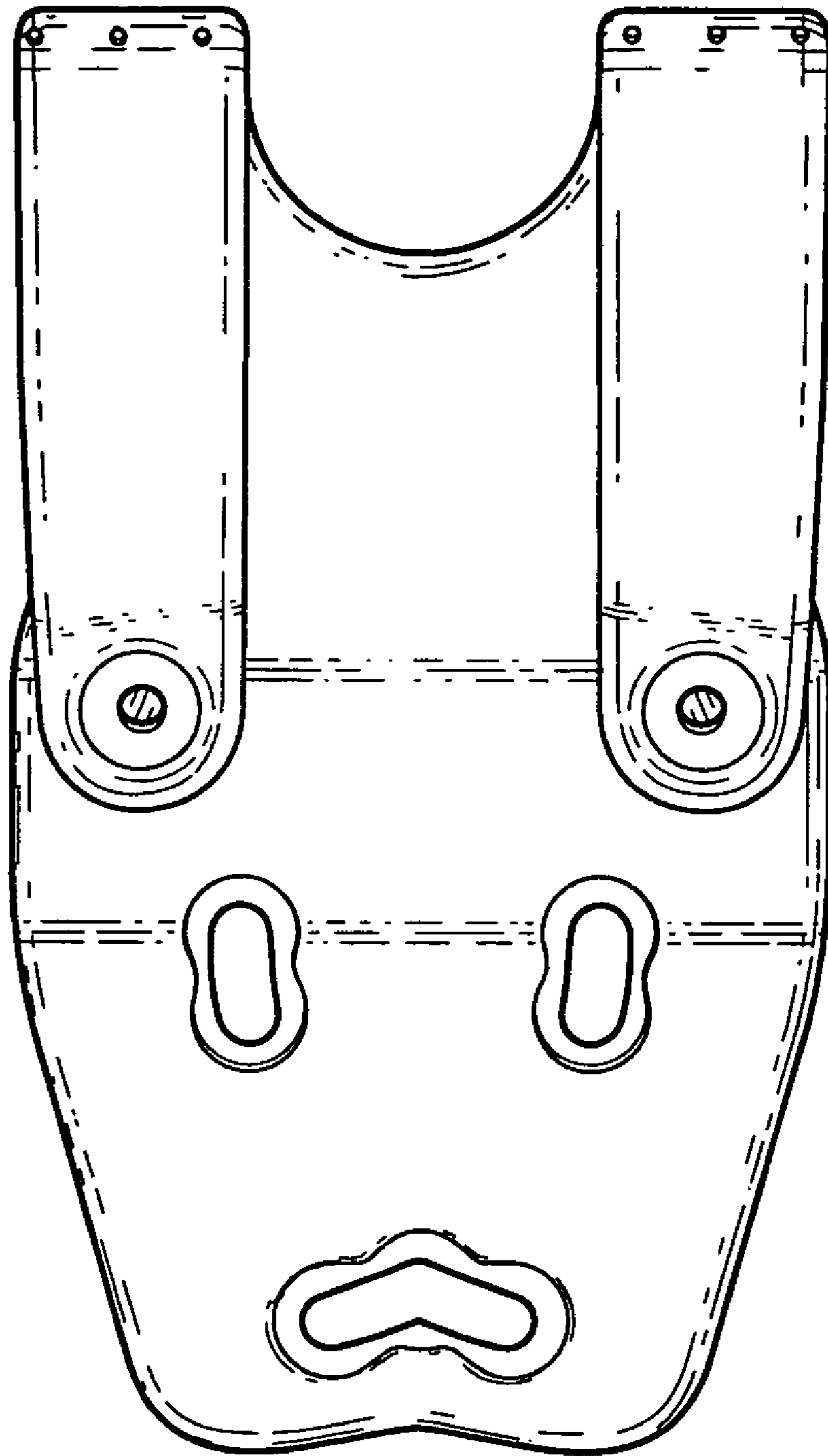

Fig. 8