



US00D567701S

(12) **United States Design Patent**  
**Nisguretsky**

(10) **Patent No.:** **US D567,701 S**

(45) **Date of Patent:** **\*\* Apr. 29, 2008**

(54) **JEWELRY ARRANGEMENT**

(75) Inventor: **Barry Nisguretsky**, Brooklyn, NY (US)

(73) Assignee: **Verragio Ltd.**, New York, NY (US)

(\*\*) Term: **14 Years**

(21) Appl. No.: **29/216,450**

(22) Filed: **Nov. 3, 2004**

**Related U.S. Application Data**

(63) Continuation-in-part of application No. 10/936,352, filed on Sep. 8, 2004, now abandoned.

(51) **LOC (8) Cl.** ..... **11-01**

(52) **U.S. Cl.** ..... **D11/39**

(58) **Field of Classification Search** ..... D11/1,  
D11/2, 6, 7, 8, 9, 10, 11, 12, 16, 26-28, 47,  
D11/34-43, 75, 89-93; 63/20, 22, 23, 26-33;  
428/133; 384/120; D12/122

See application file for complete search history.

(56) **References Cited**

**U.S. PATENT DOCUMENTS**

D61,573	S	*	10/1922	Herzog	.....	D11/38
1,599,811	A	*	9/1926	Eliasoff	.....	D11/38
D126,085	S	*	3/1941	Bauernfeind	.....	D11/38
D159,656	S	*	8/1950	Linden	.....	D11/38
D184,833	S	*	4/1959	Sager	.....	D11/39
3,406,979	A	*	10/1968	Weber	.....	277/629
3,553,817	A	*	1/1971	Lallak	.....	29/235
3,687,493	A	*	8/1972	Lock et al.	.....	285/333
4,043,727	A	*	8/1977	Henzl	.....	425/578
D262,199	S	*	12/1981	Bogner et al.	.....	D11/38
4,327,600	A	*	5/1982	Bennett	.....	74/502.4
4,427,204	A	*	1/1984	Alley	.....	277/390
6,010,162	A	*	1/2000	Grau et al.	.....	285/257
6,062,045	A	*	5/2000	West	.....	D11/39
6,186,858	B1	*	2/2001	Cotoia	.....	446/250

D522,903 S \* 6/2006 Jorgensen ..... D11/26  
2005/0199007 A1\* 9/2005 LaCroix ..... 63/15

\* cited by examiner

*Primary Examiner*—Cathron Brooks

*Assistant Examiner*—Michael A. Pratt

(74) *Attorney, Agent, or Firm*—Dorsey & Whitney LLP

(57) **CLAIM**

The ornamental design for the jewelry arrangement, as shown and described.

**DESCRIPTION**

FIG. 1 is a perspective view of a first exemplary embodiment of a jewelry arrangement showing my new design;

FIG. 2 is an exploded perspective view thereof;

FIG. 3 is another exploded perspective view thereof;

FIG. 4 is a top plan view thereof;

FIG. 5 is a side elevation view thereof;

FIG. 6 is a perspective view of a second embodiment of the jewelry arrangement;

FIG. 7 is an exploded perspective view thereof; and

FIG. 8 is a side elevation view thereof;

FIG. 9 is a perspective view of a third embodiment of the jewelry arrangement;

FIG. 10 is an exploded perspective view thereof; and,

FIG. 11 is a side elevation view thereof.

The broken lines are provided for illustrative purposes only, and form no part of the claimed design. In addition, the portions of the jewelry arrangement that are not shown in the drawing do not form any part of the claimed design. The portions in the drawings that are provided in solid lines show and thus claim section(s) of the respective surface(s) of the jewelry arrangement.

**1 Claim, 4 Drawing Sheets**

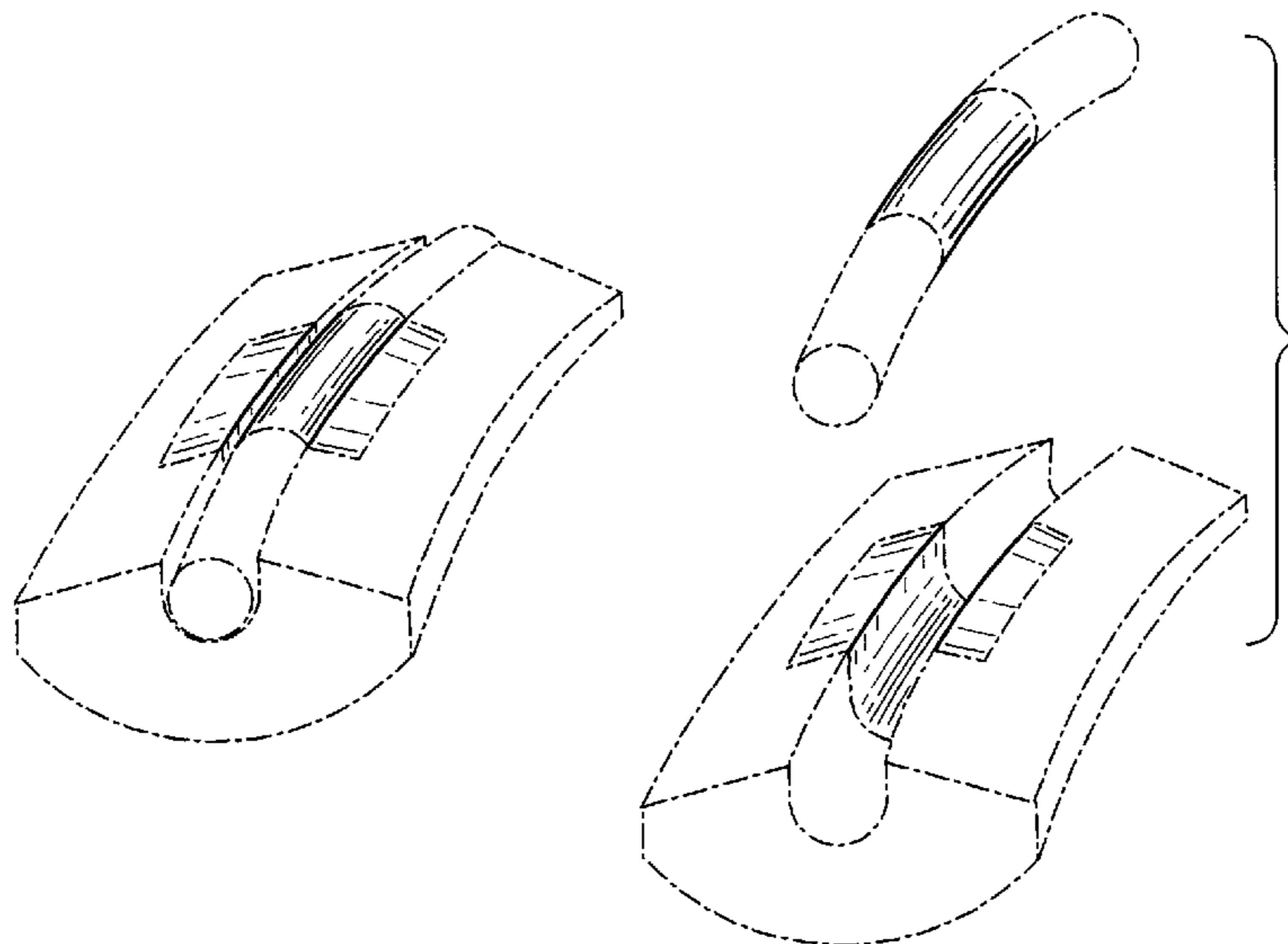

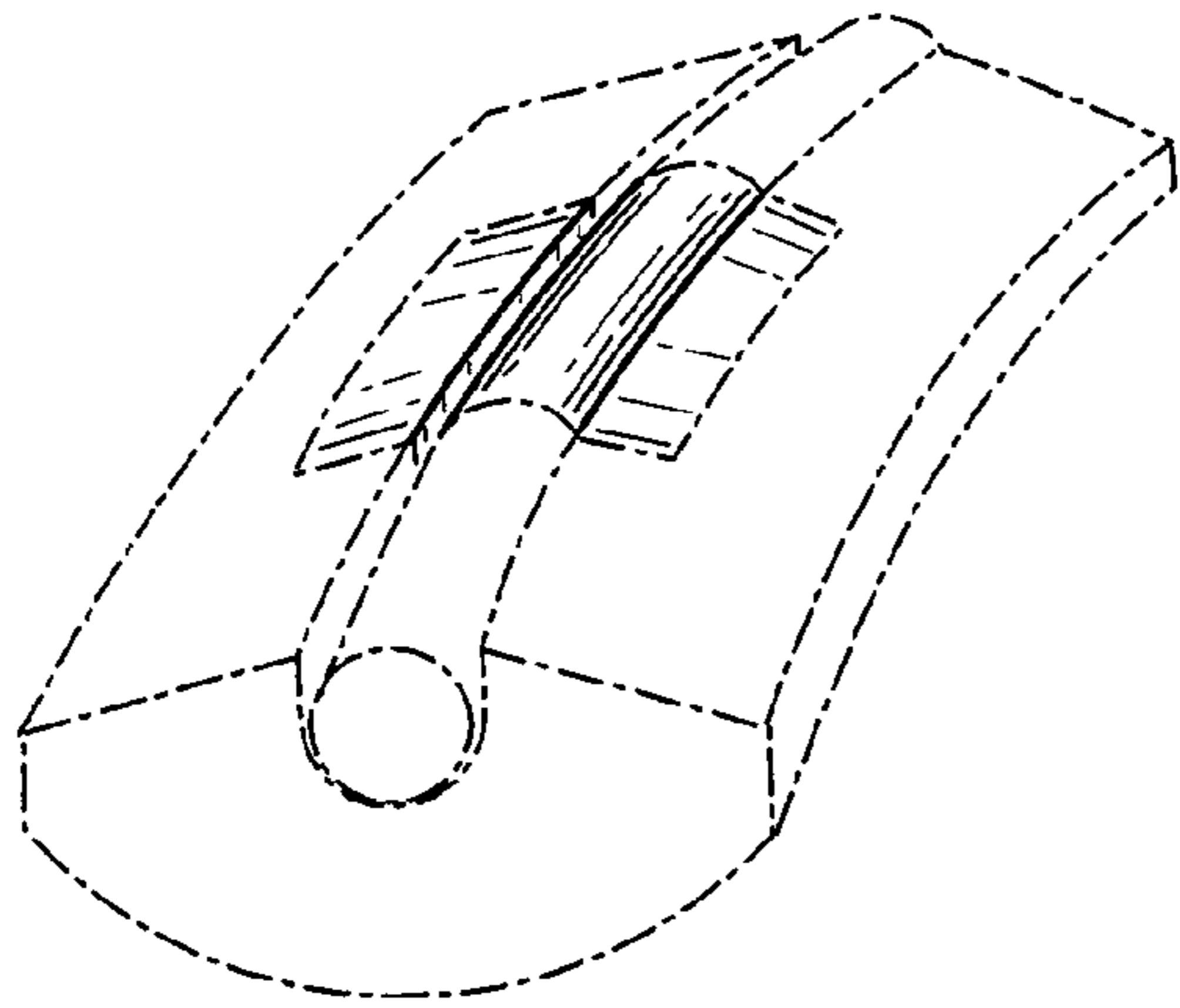

FIG. 1

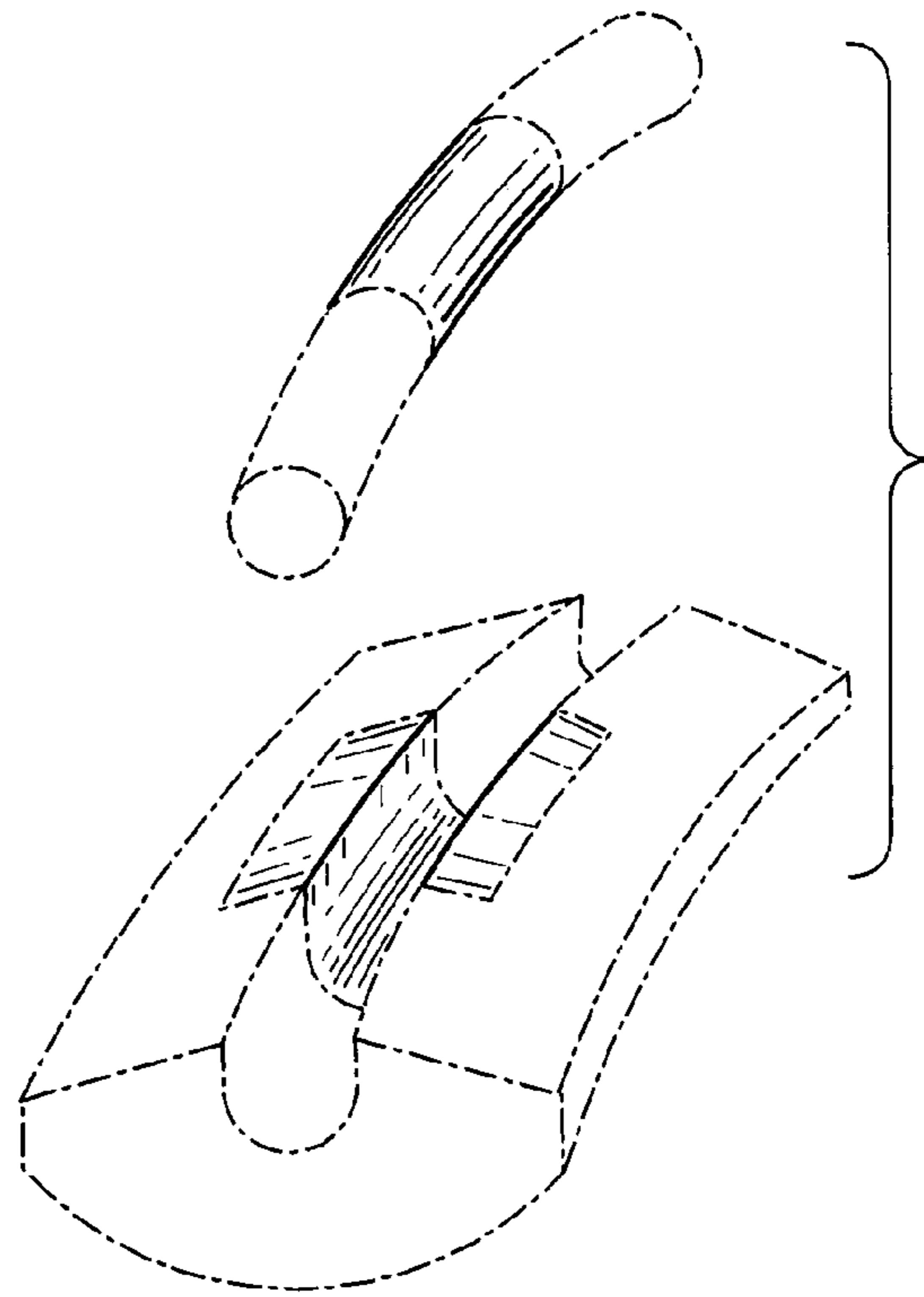

FIG. 2

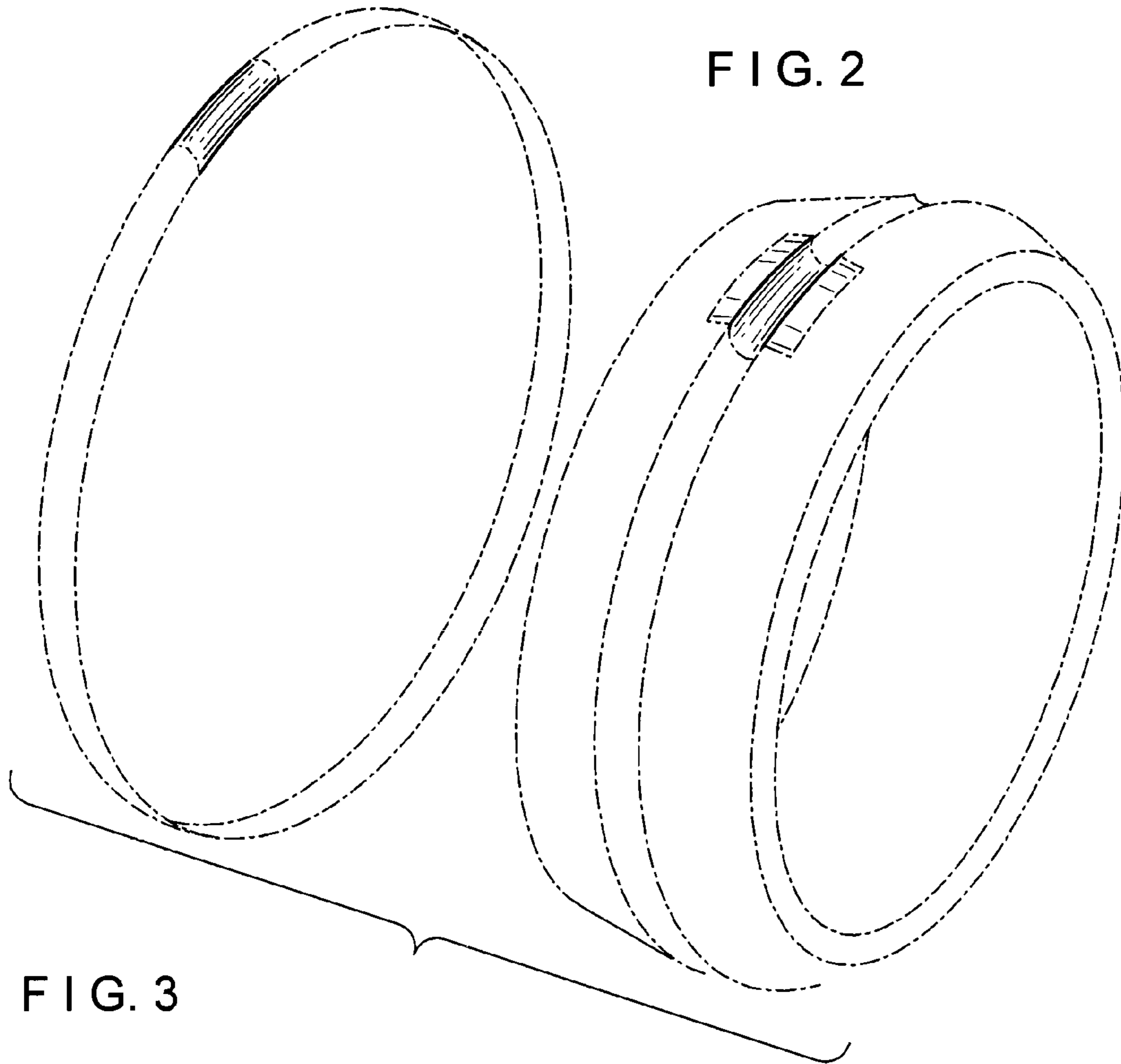

FIG. 3

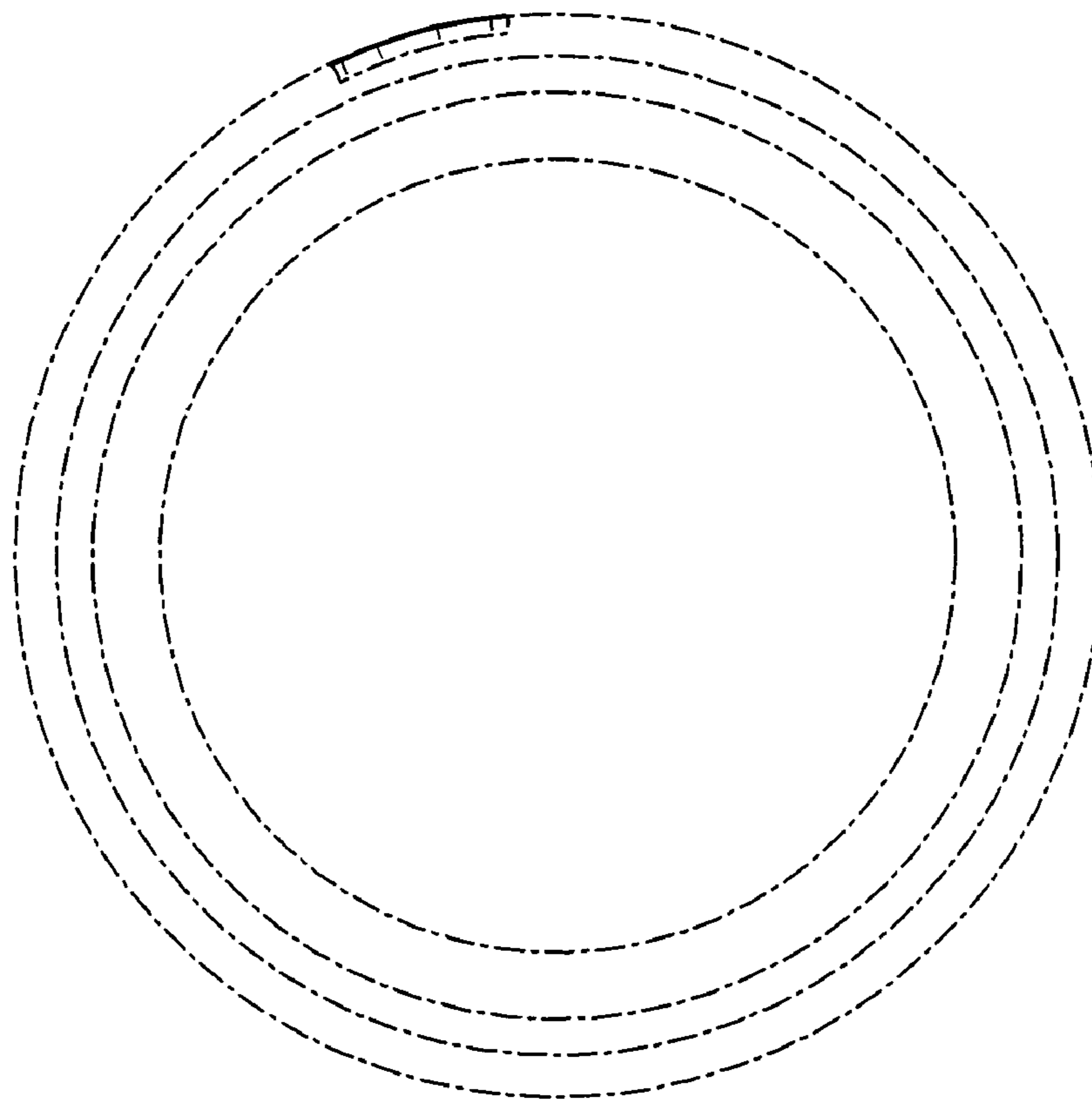

FIG. 4

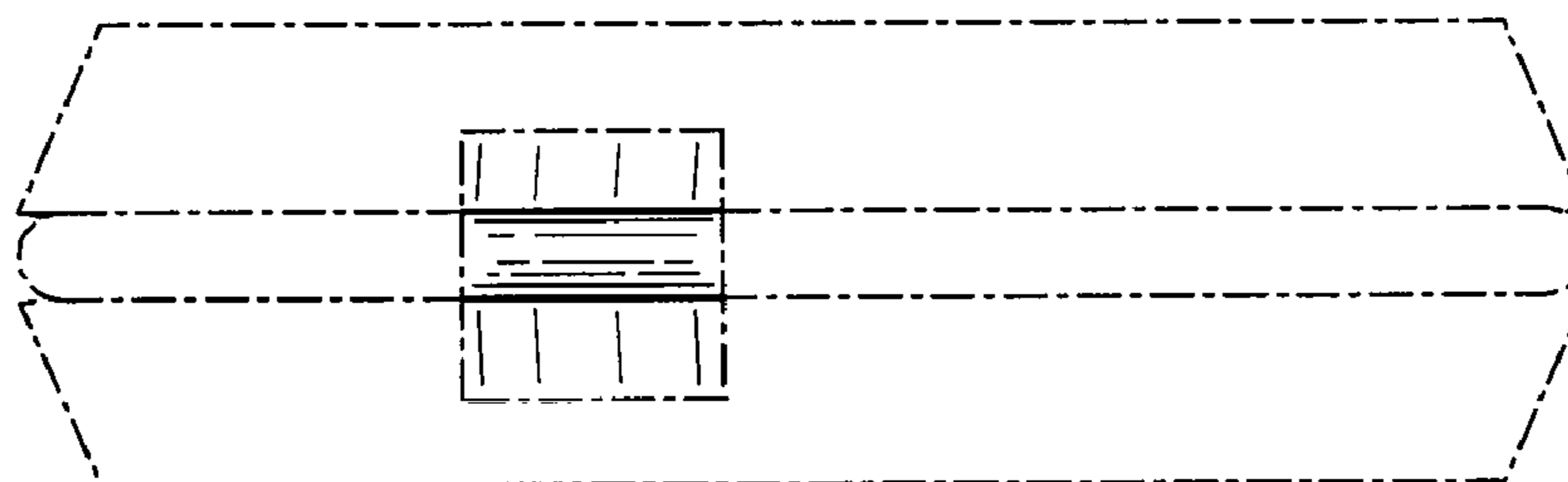

FIG. 5

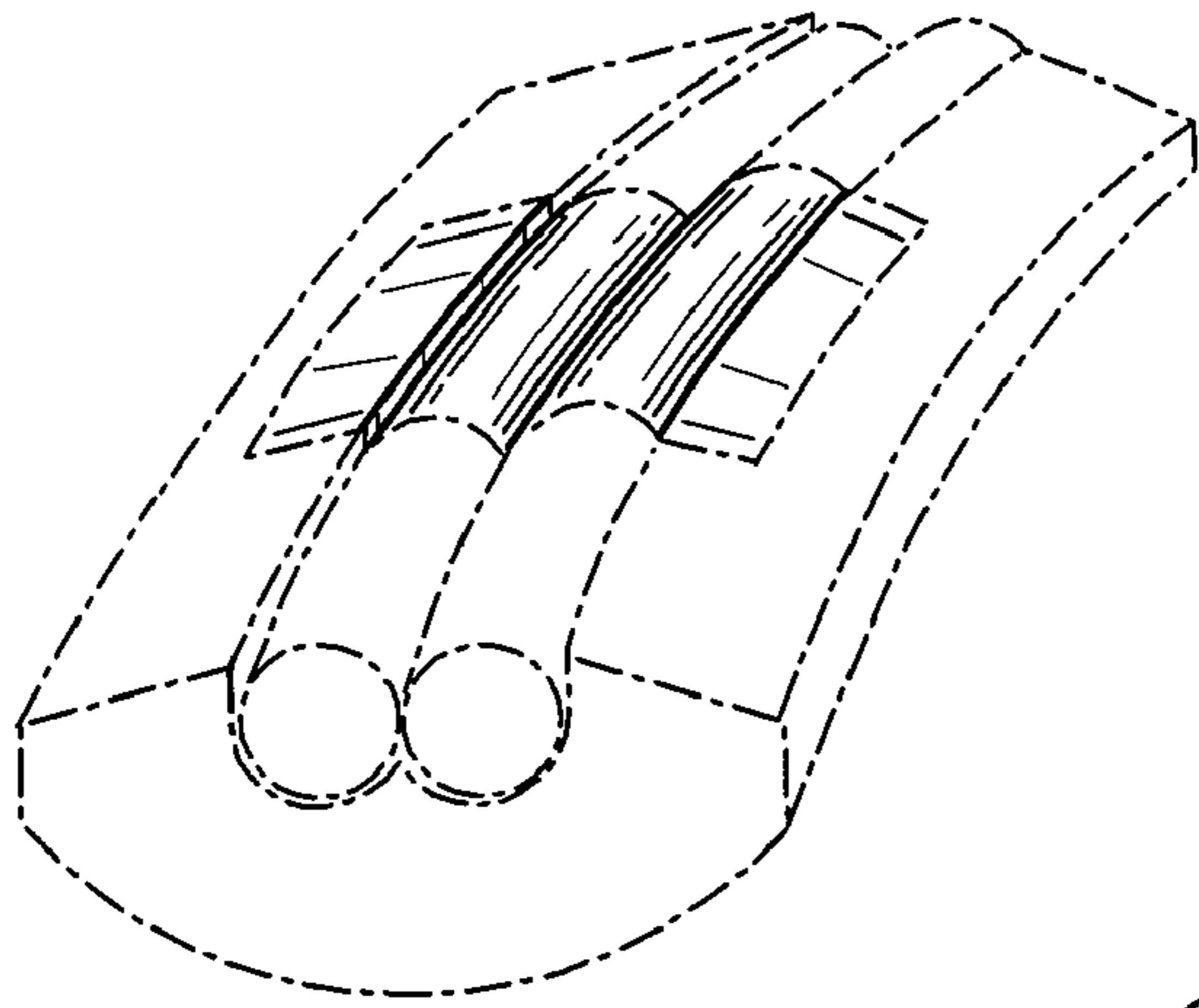

FIG. 6

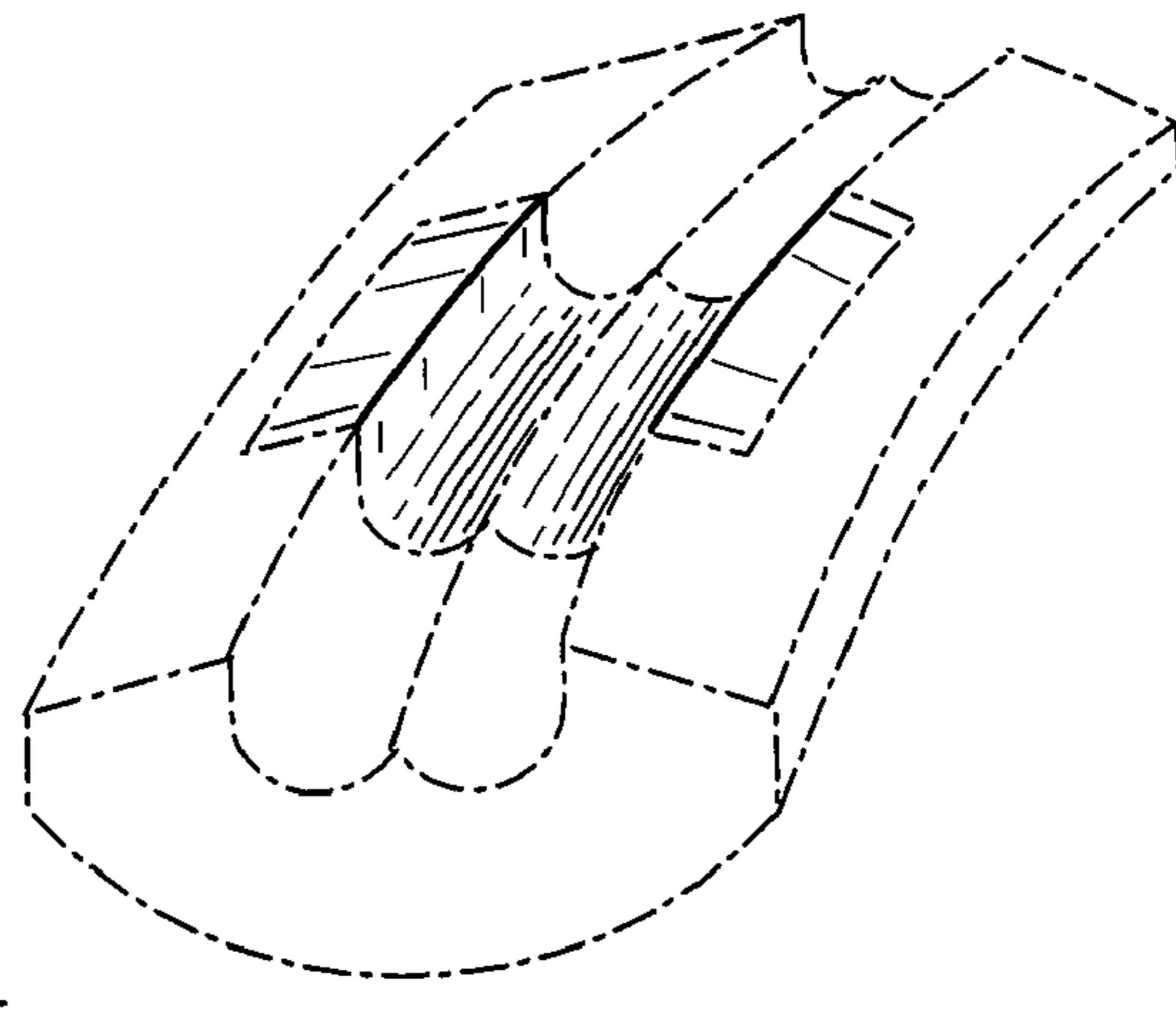
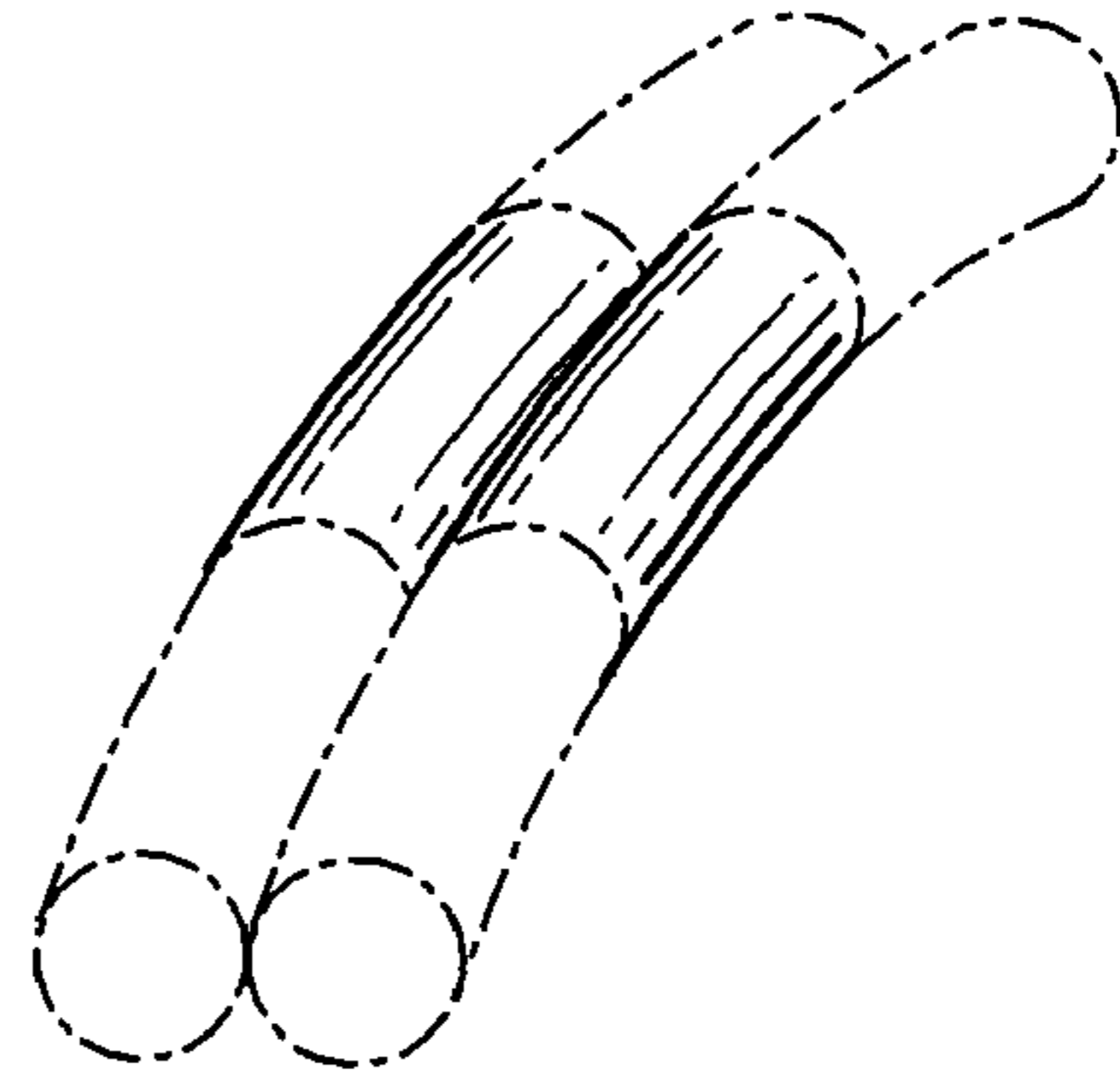

FIG. 7

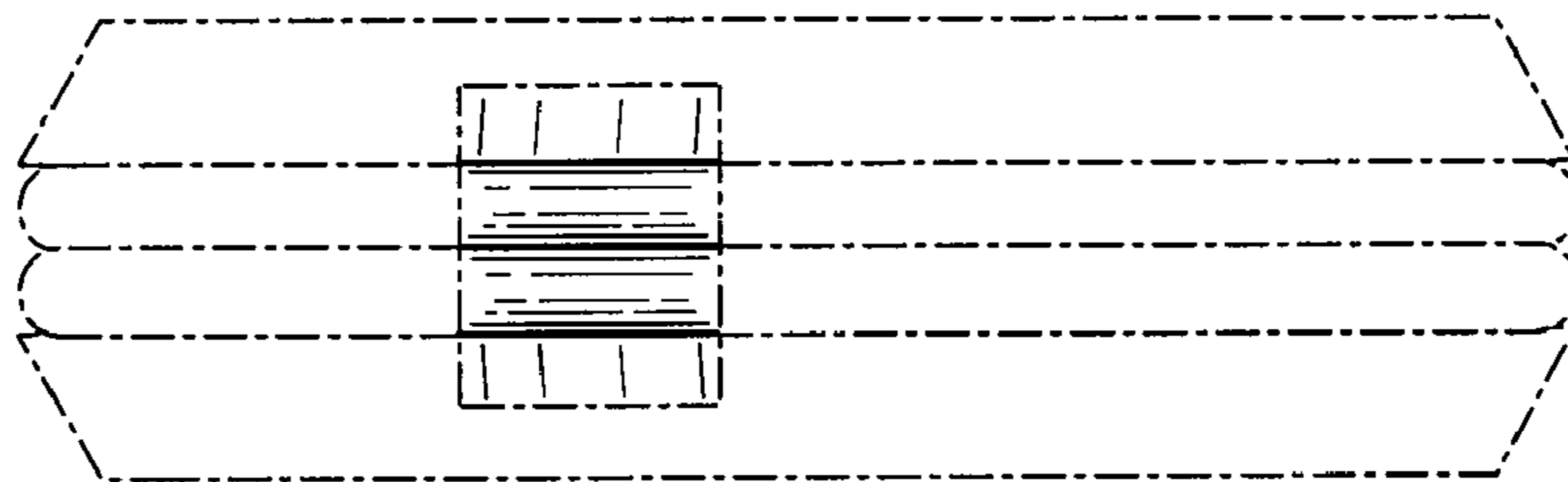

FIG. 8



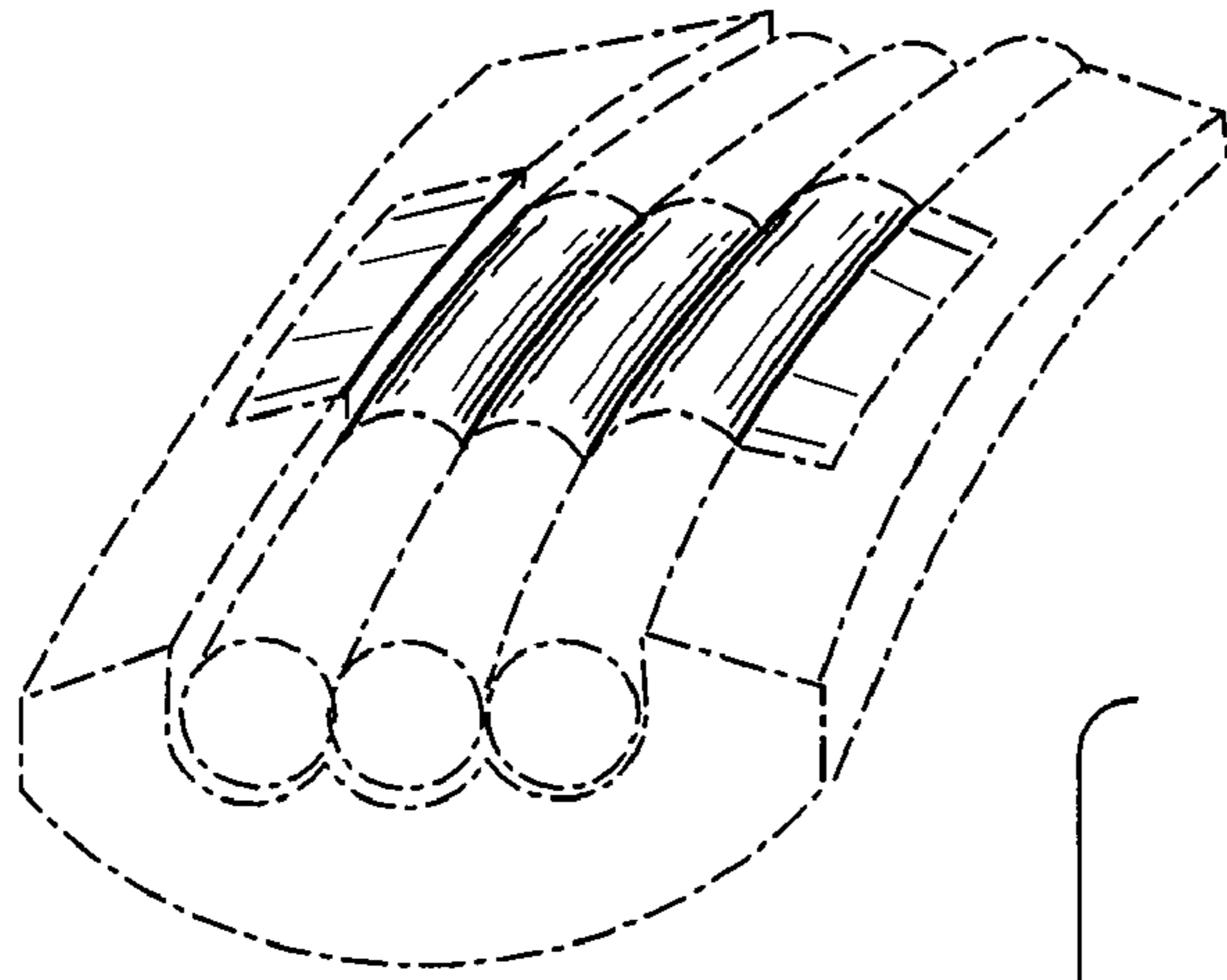

FIG. 9

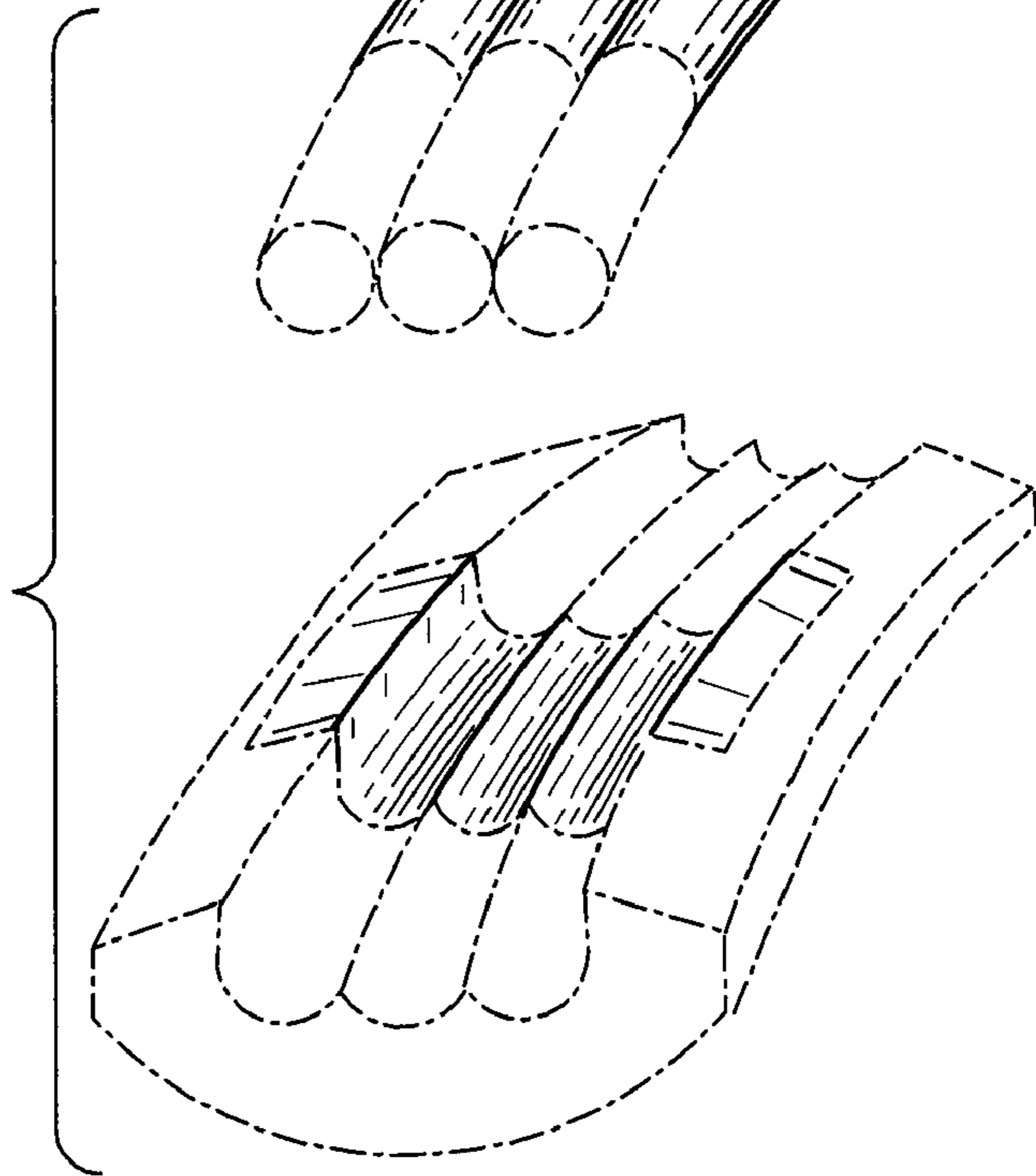
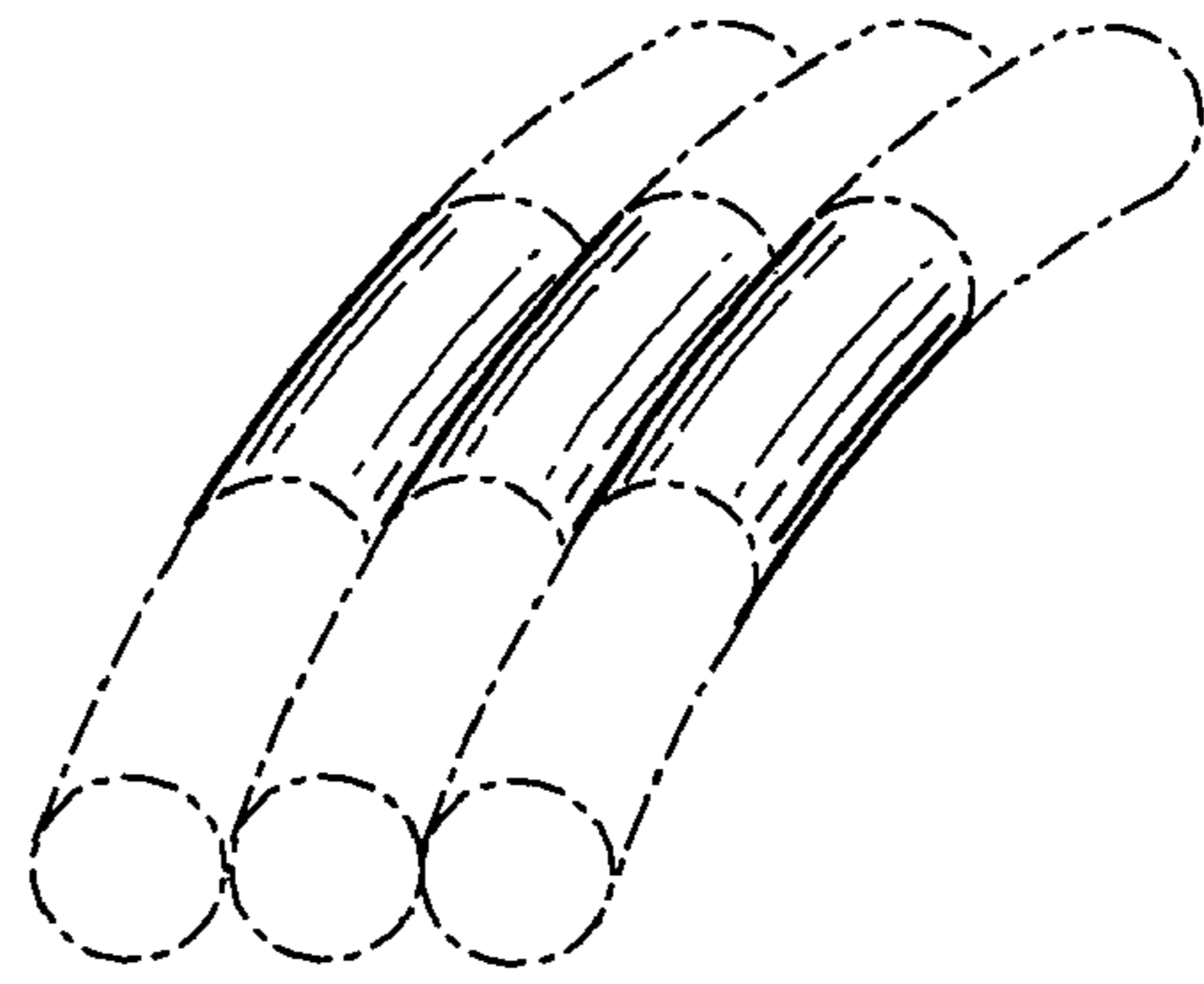

FIG. 10

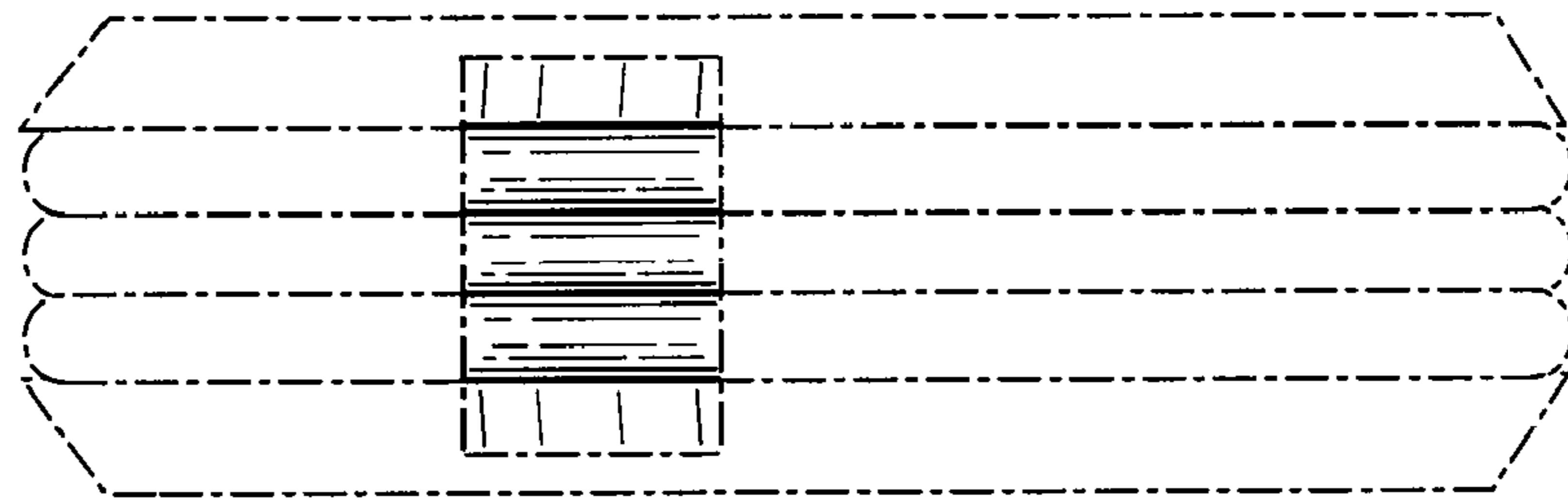

FIG. 11