



US00D567571S

(12) **United States Design Patent** (10) **Patent No.:** **US D567,571 S**
Hillmann et al. (45) **Date of Patent:** **** *Apr. 29, 2008**

(54) **COMBINATION STEAMER**

(75) Inventors: **Johannes Hillmann**, Neu-Ulm (DE);
Frank Förster, Oberkirch (DE)

(73) Assignee: **Eloma GmbH Innovative Koch -und
Backtechnik**, Maisach (DE)

(*) Notice: This patent is subject to a terminal disclaimer.

(**) Term: **14 Years**

(21) Appl. No.: **29/272,433**

(22) Filed: **Feb. 8, 2007**

(30) **Foreign Application Priority Data**

Aug. 8, 2006 (EM) 000572060

(51) **LOC (8) Cl.** **07-02**

(52) **U.S. Cl.** **D7/347**

(58) **Field of Classification Search** D7/350.1,
D7/350.2, 350.3, 350.4, 351, 402-403, 405-406,
D7/339, 347-348; 126/19 M, 20, 21 A,
126/273 R, 275 R, 275 E; 219/401, 402
See application file for complete search history.

(56) **References Cited**

U.S. PATENT DOCUMENTS

- D318,775 S * 8/1991 Bonnet et al. D7/350.3
- D384,544 S * 10/1997 Lieblein et al. D7/350.4
- 6,773,738 B2 * 8/2004 Berger et al. 126/20
- 7,093,592 B2 * 8/2006 Cho 126/20
- D539,593 S * 4/2007 Wang D7/350.4
- 2003/0178411 A1 * 9/2003 Manganiello et al. 219/401
- 2006/0081592 A1 * 4/2006 Williams et al. 219/401

OTHER PUBLICATIONS

- Unox catalog, "ChefLux," 12 pages. Date: Sep. 2004.
- TCStar catalog, "AngeloPo," 8 pages. Date: Nov. 2005.
- Lainox catalog, "The Mix," 24 pages. Date: Jan. 2006.
- Unox catalog, "Fachhandelspreisliste 2006," 43 pages. Date: Jan. 1, 2006.

Rational catalog, "ClimaPlus Combi," 50 pages. Date: Undated.
Convothem brochure, "Die Grill-Spieb-Version," 2 pages. Date: Undated.

Convothem brochure, "Die Back-Version," 2 pages. Date: Undated.

* cited by examiner

Primary Examiner—Catherine R. Oliver

(74) *Attorney, Agent, or Firm*—Jansson Shupe & Munger Ltd.

(57) **CLAIM**

The ornamental design for a combination steamer, as shown and described.

DESCRIPTION

FIG. 1 is a perspective view of a combination steamer.

FIG. 2 is a front elevation view of the combination steamer of FIG. 1.

FIG. 3 is a back elevation view of the combination steamer of FIG. 1.

FIG. 4 is a left side elevation view of the combination steamer of FIG. 1.

FIG. 5 is a right side elevation view of the combination steamer of FIG. 1.

FIG. 6 is a top plan view of the combination steamer of FIG. 1.

FIG. 7 is a bottom plan view of the combination steamer of FIG. 1.

FIG. 8 is a perspective view of a second embodiment of the design of FIG. 1, the only difference being in size proportions.

FIG. 9 is a front elevation view of the combination steamer of FIG. 8.

FIG. 10 is a back elevation view of the combination steamer of FIG. 8.

FIG. 11 is a left side elevation view of the combination steamer of FIG. 8.

FIG. 12 is a right side elevation view of the combination steamer of FIG. 8.

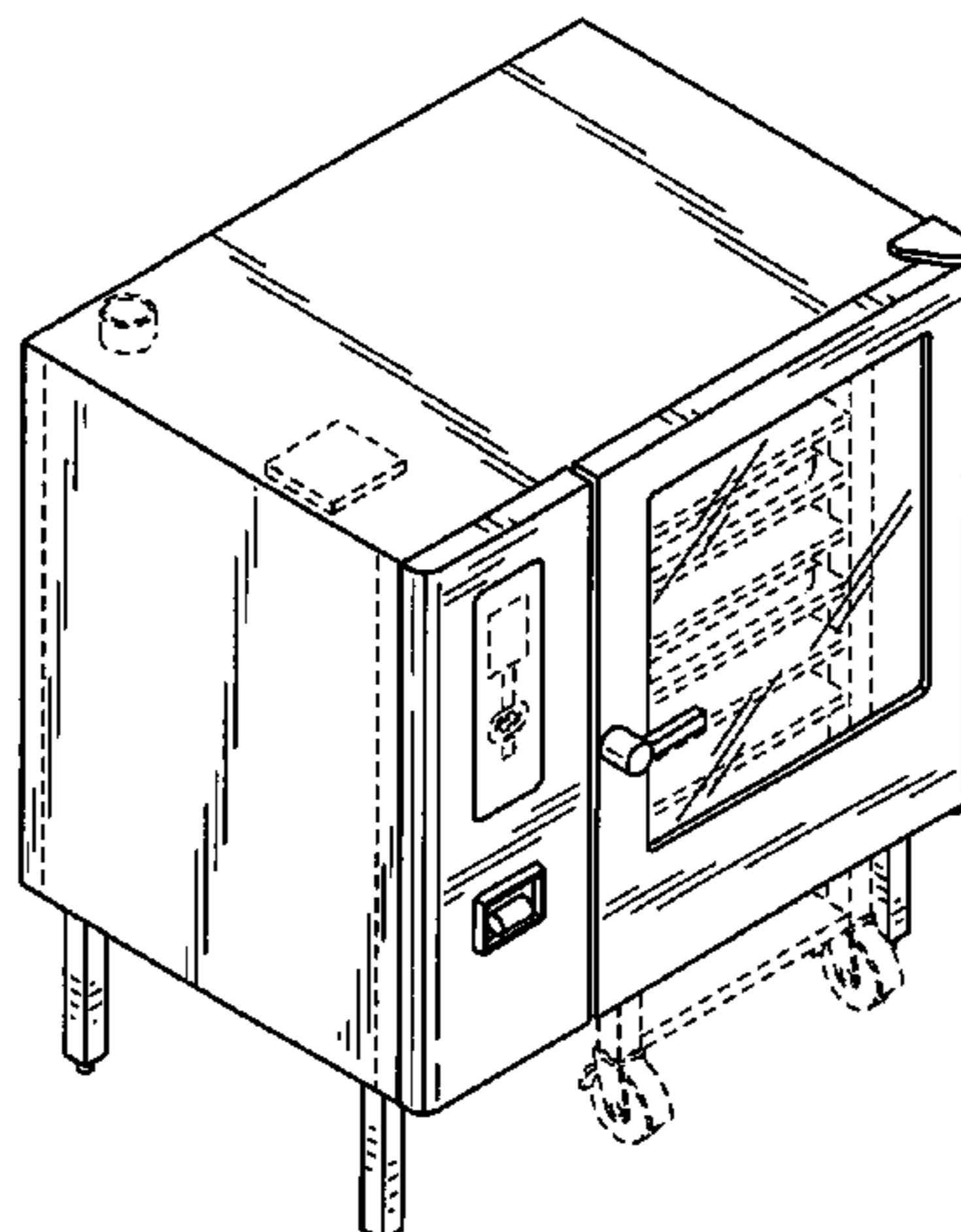

FIG. 13 is a top plan view of the combination steamer of FIG. 8.

FIG. 14 is a bottom plan view of the combination steamer of FIG. 8.

FIG. 15 is a perspective view of a third embodiment of the design of FIG. 1, the only difference being in size proportions.

FIG. 16 is a front elevation view of the combination steamer of FIG. 15.

FIG. 17 is a back elevation view of the combination steamer of FIG. 15.

FIG. 18 is a left side elevation view of the combination steamer of FIG. 15.

FIG. 19 is a right side elevation view of the combination steamer of FIG. 15.

FIG. 20 is a top plan view of the combination steamer of FIG. 15; and,

FIG. 21 is a bottom plan view of the combination steamer of FIG. 15.

The broken lines are provided for illustrative purposes only and form no part of the claimed design.

1 Claim, 13 Drawing Sheets

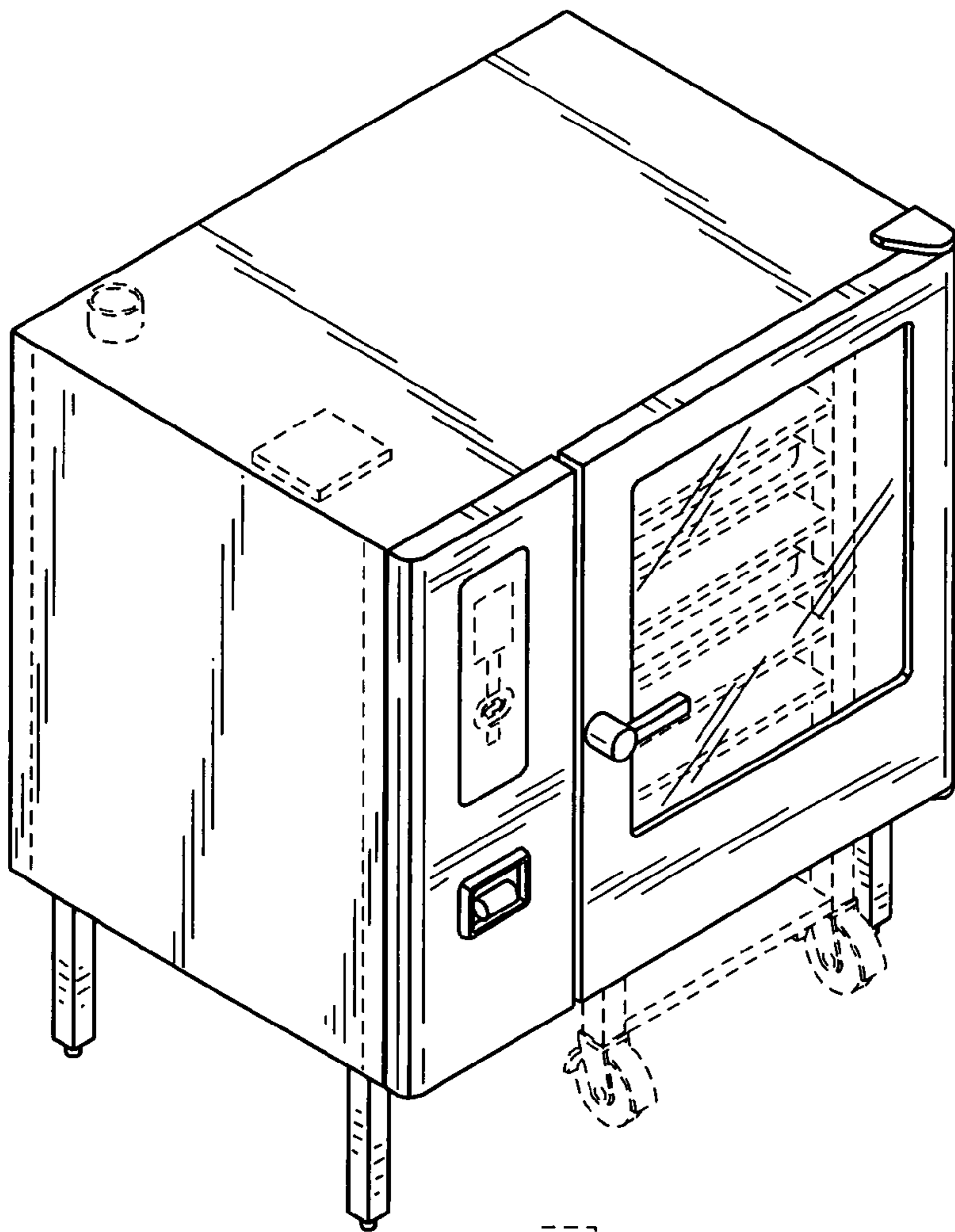

FIG. 1

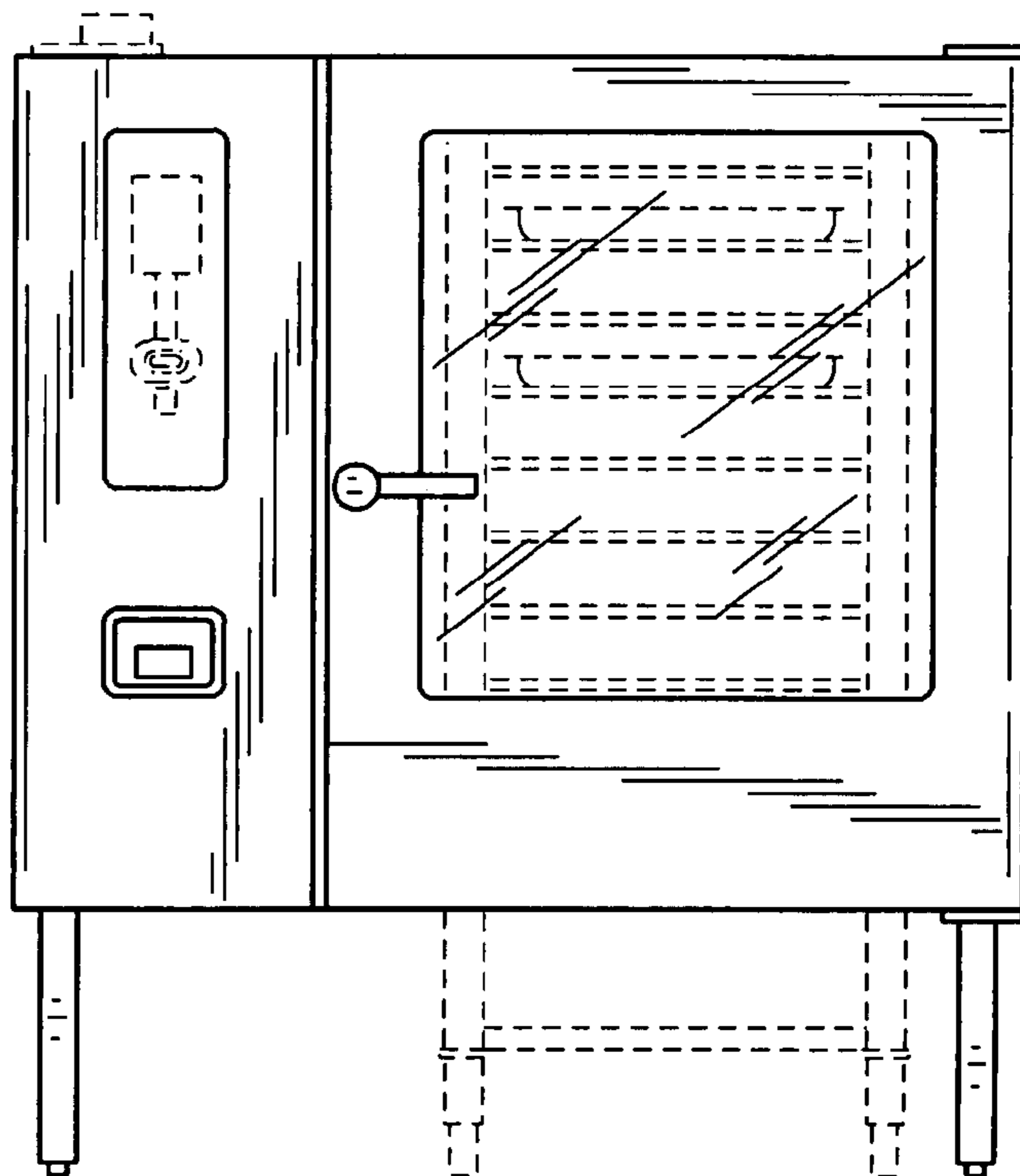

FIG. 2

FIG. 3

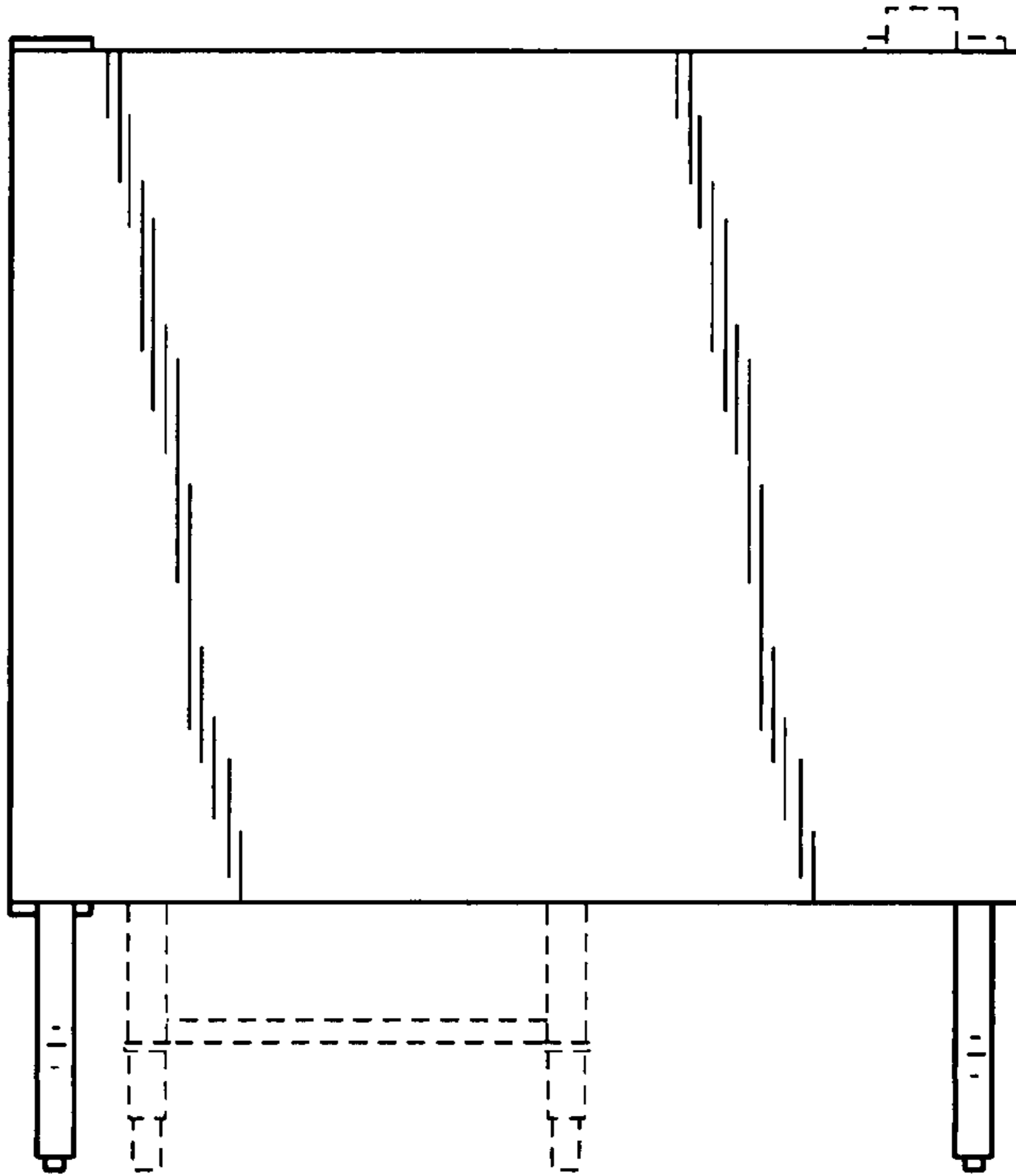

FIG. 4

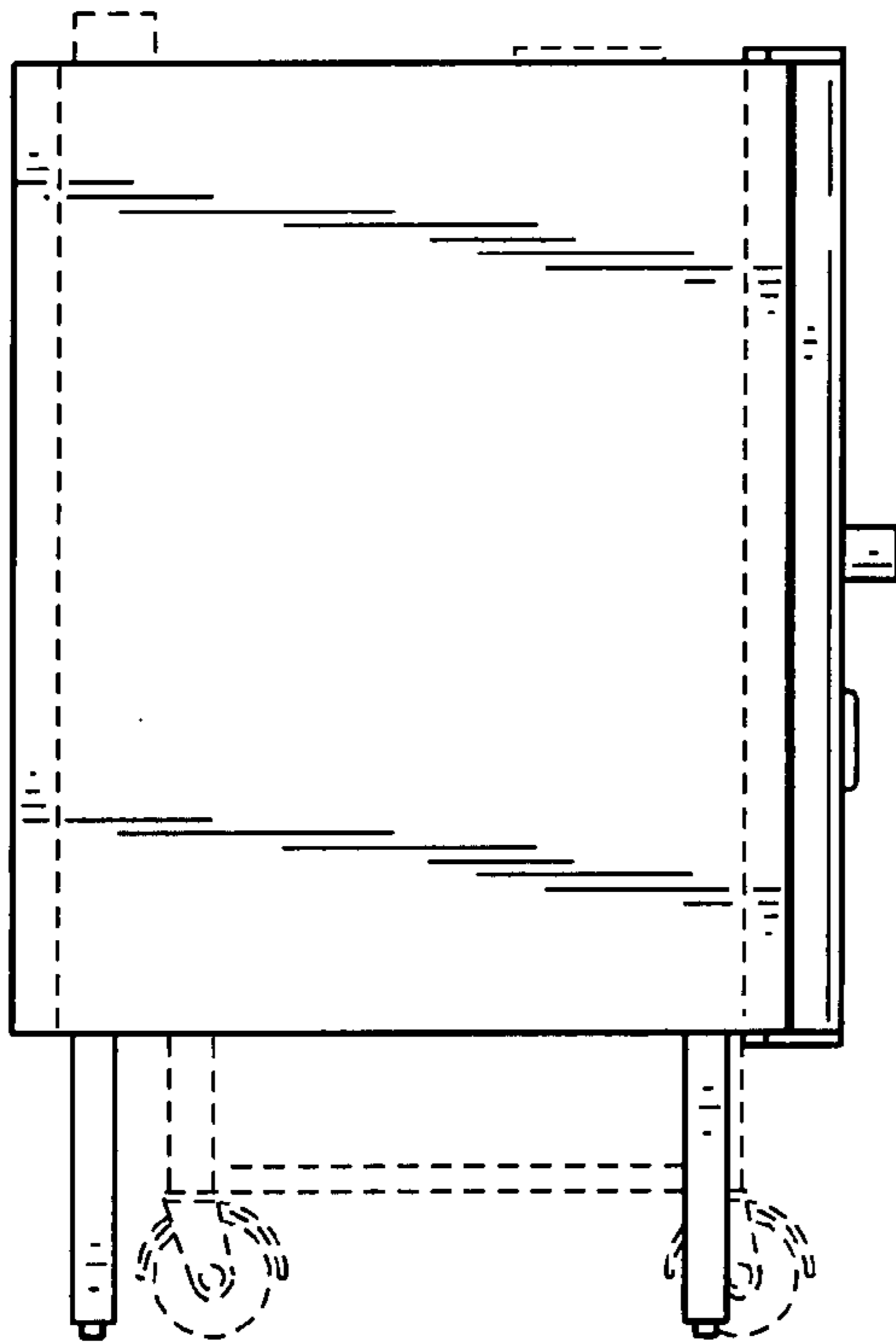

FIG. 5

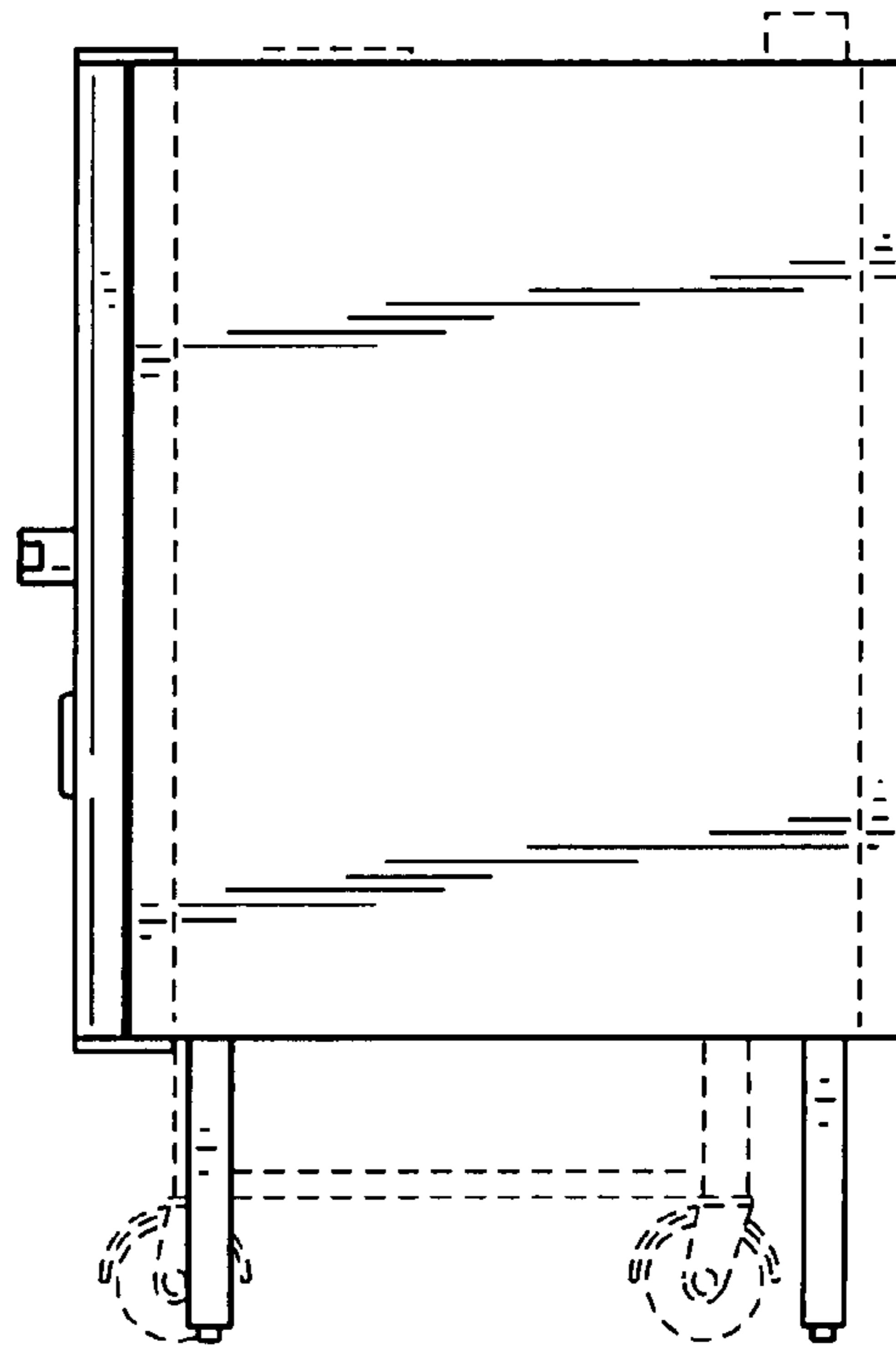
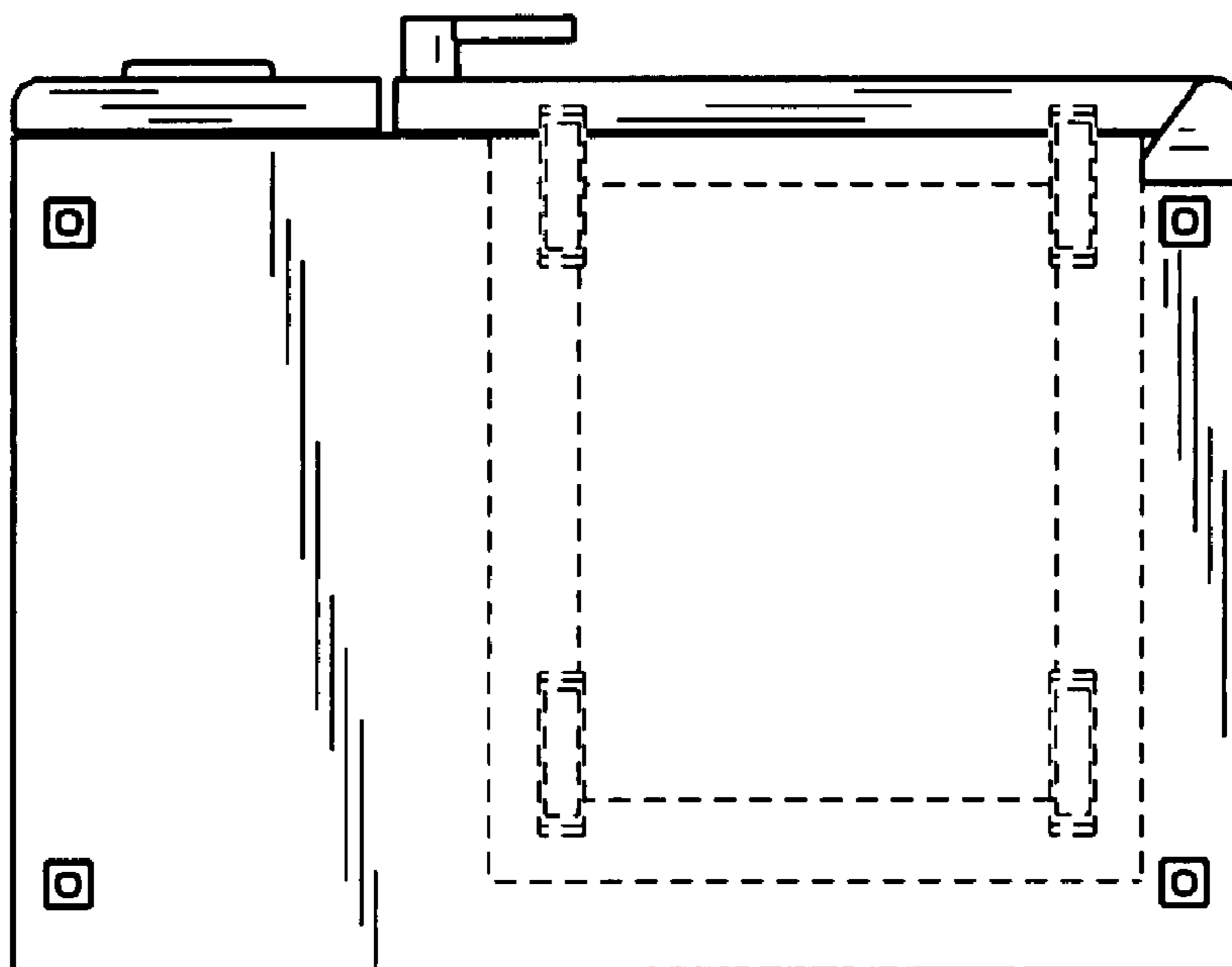

FIG. 6



FIG. 7



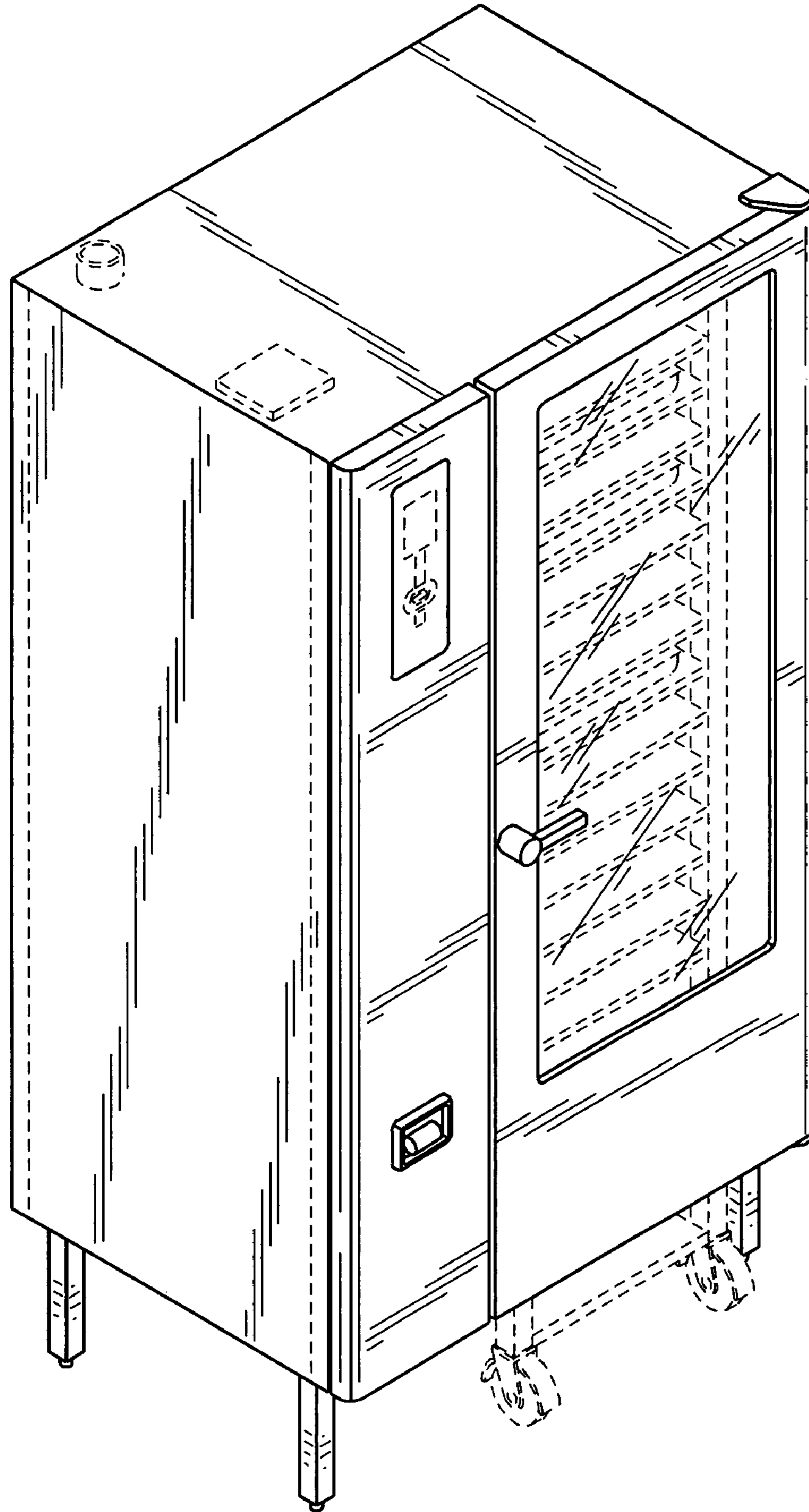

FIG. 8

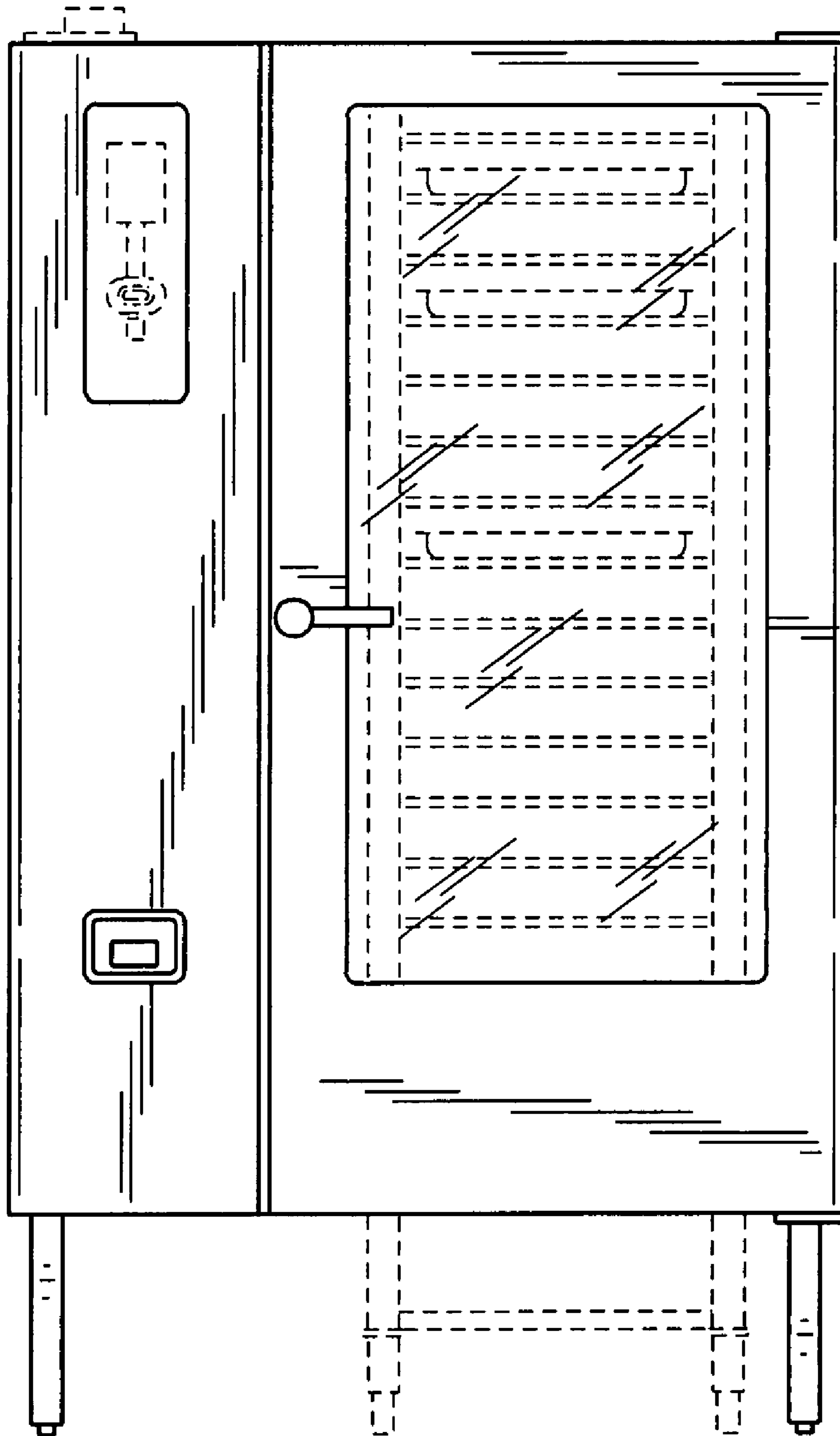

FIG. 9

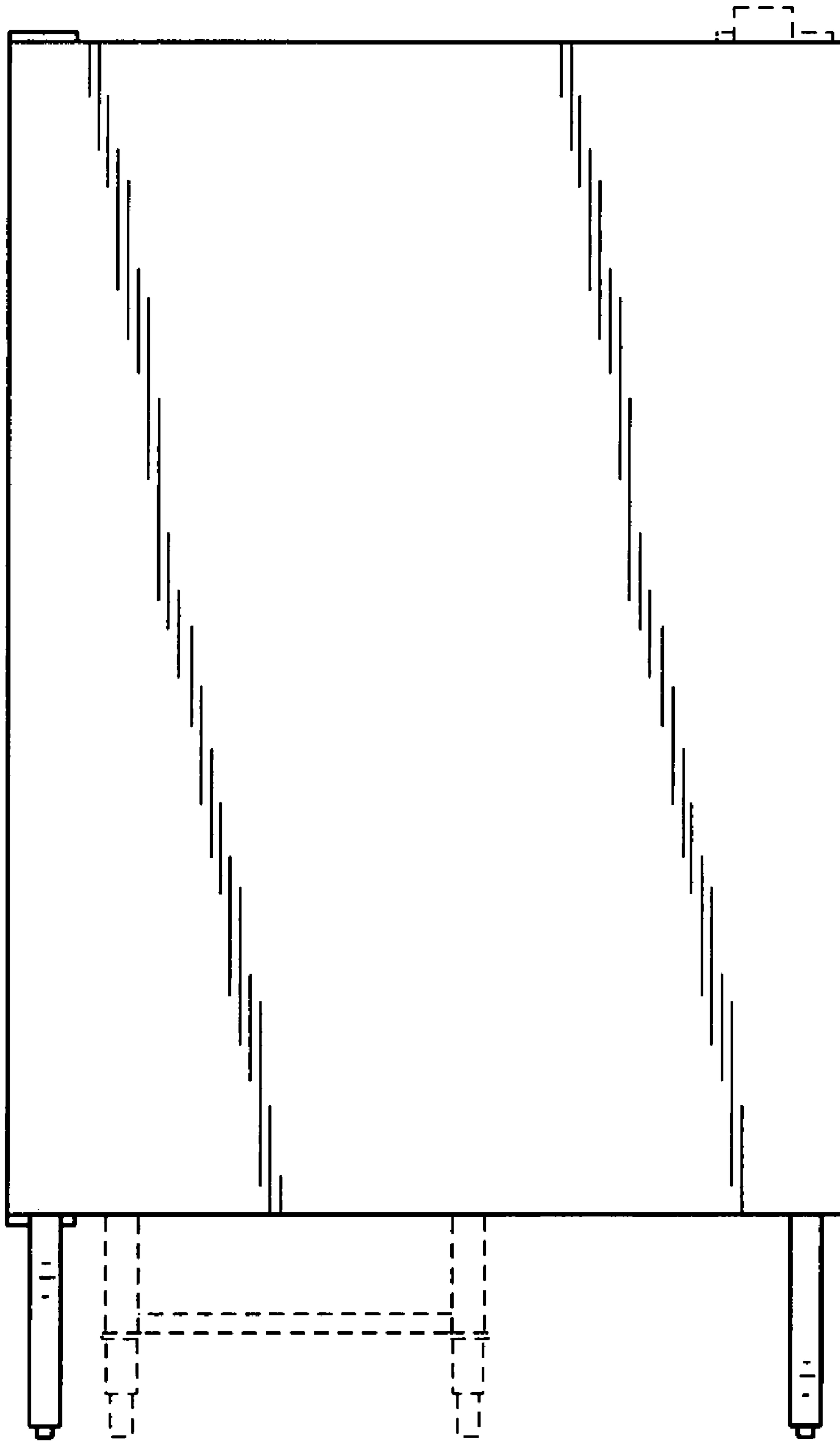

FIG. 10

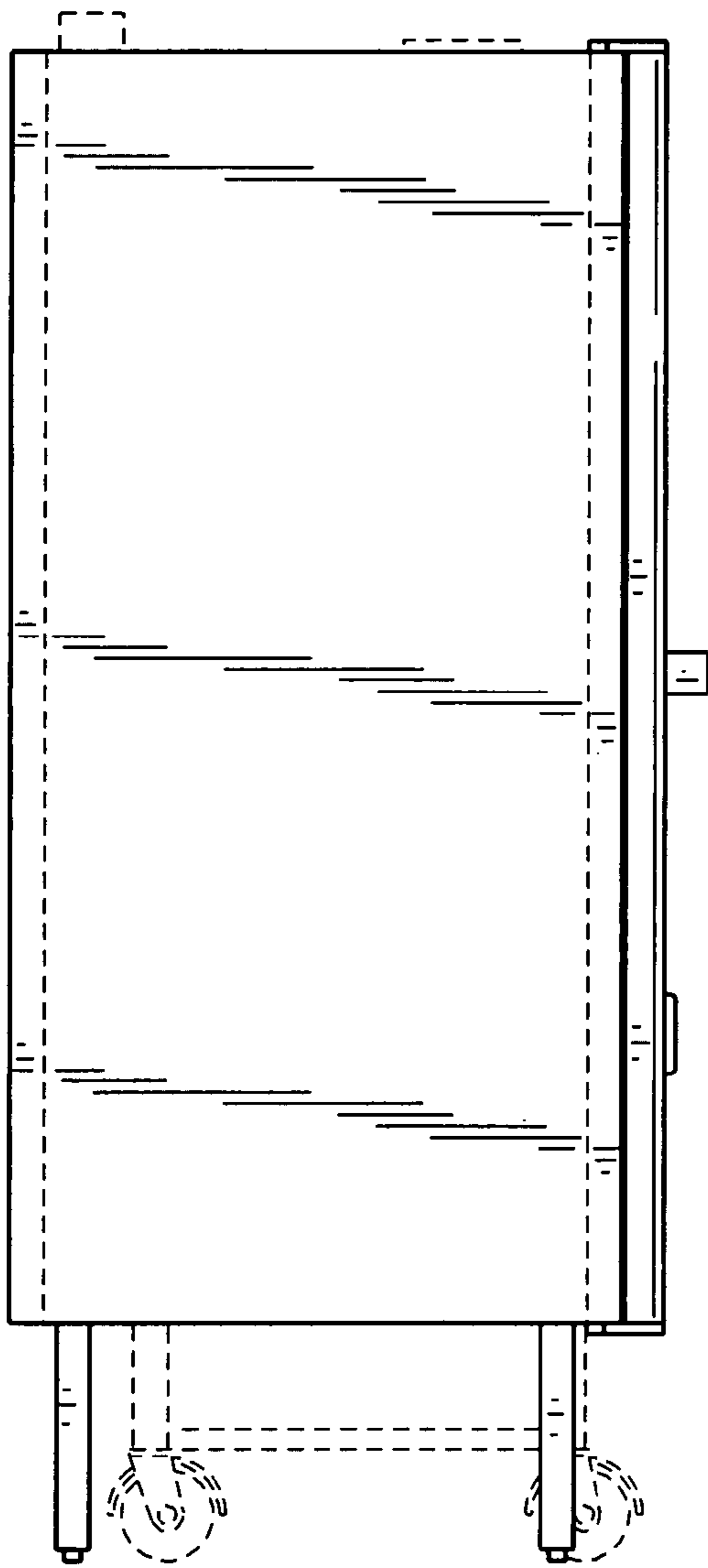

FIG. 11

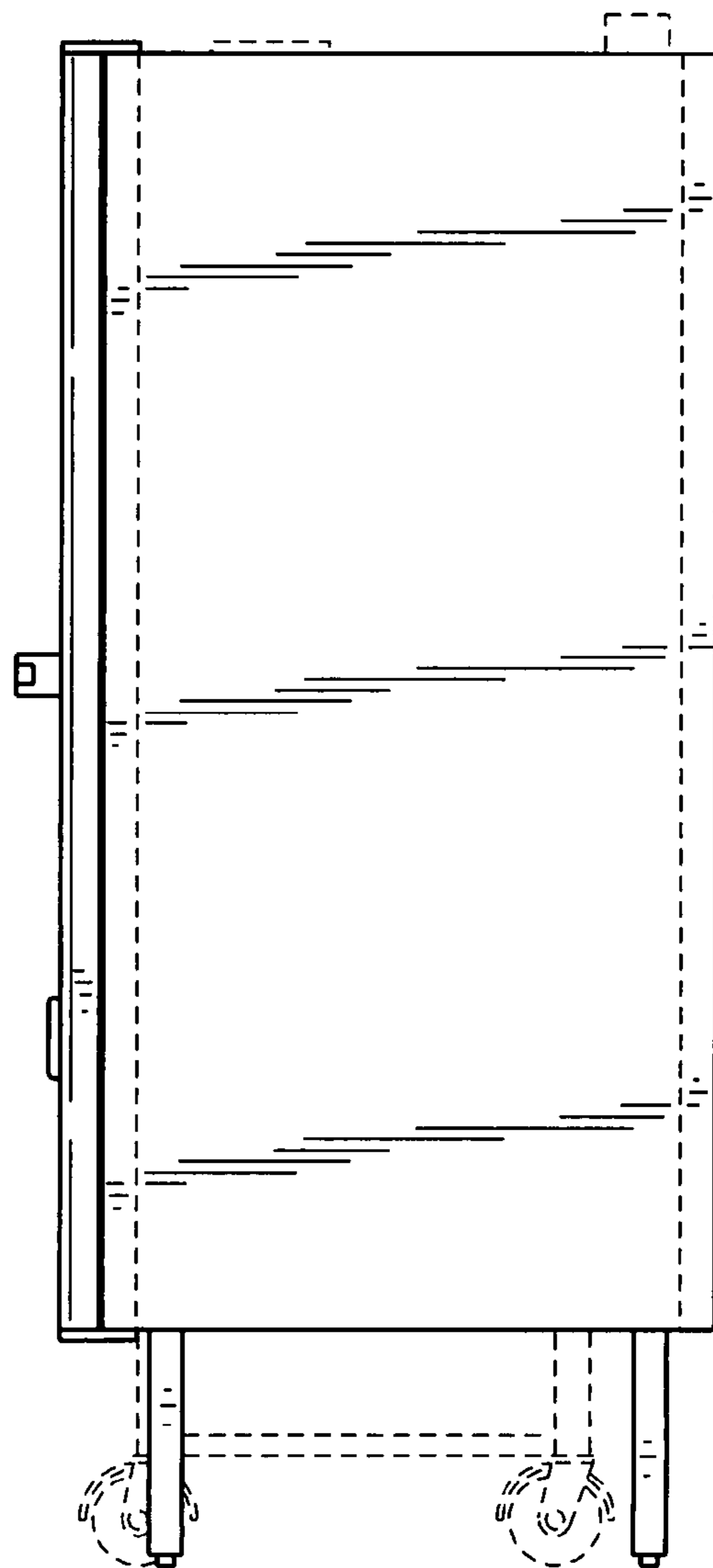

FIG. 12

FIG. 13

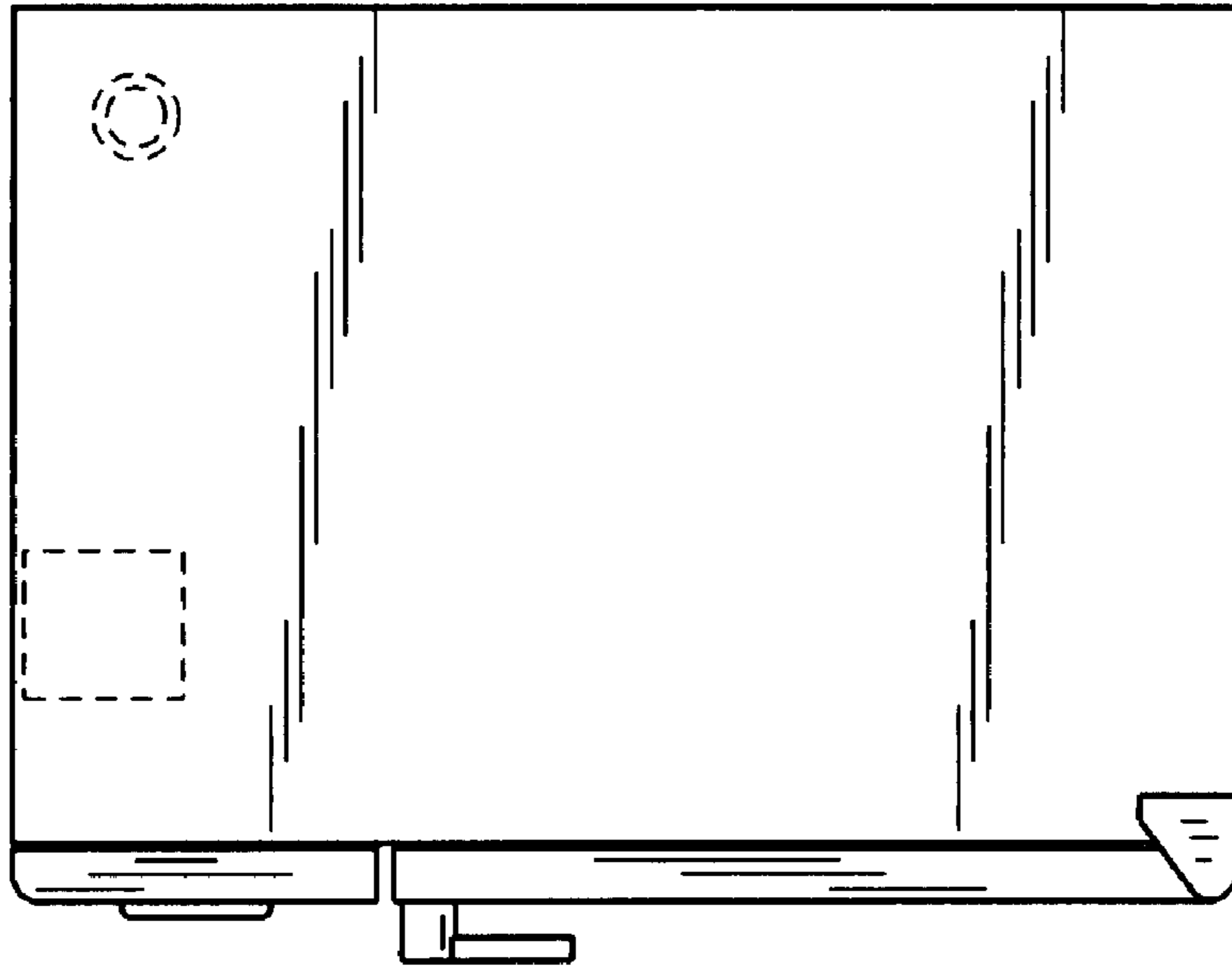
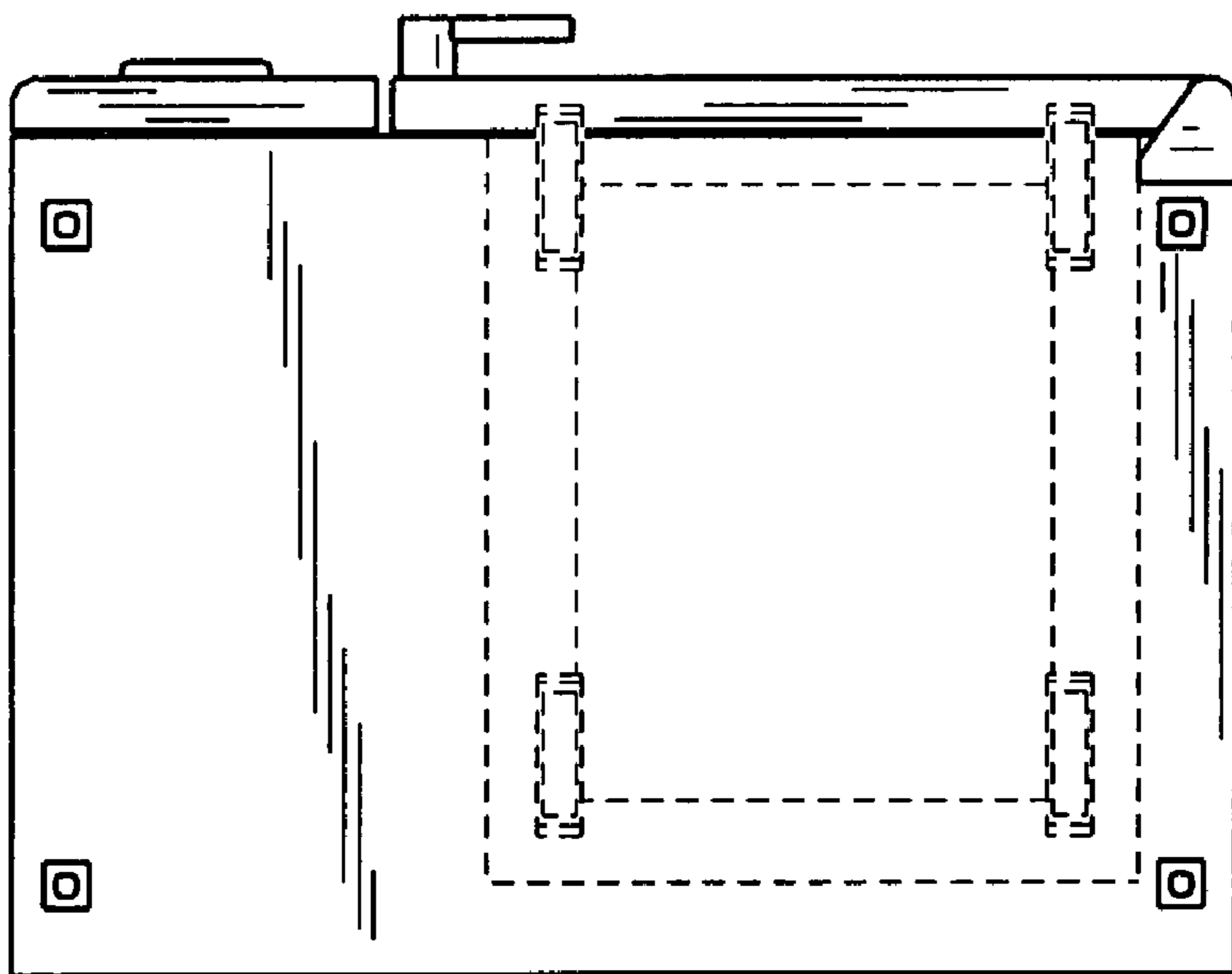

FIG. 14



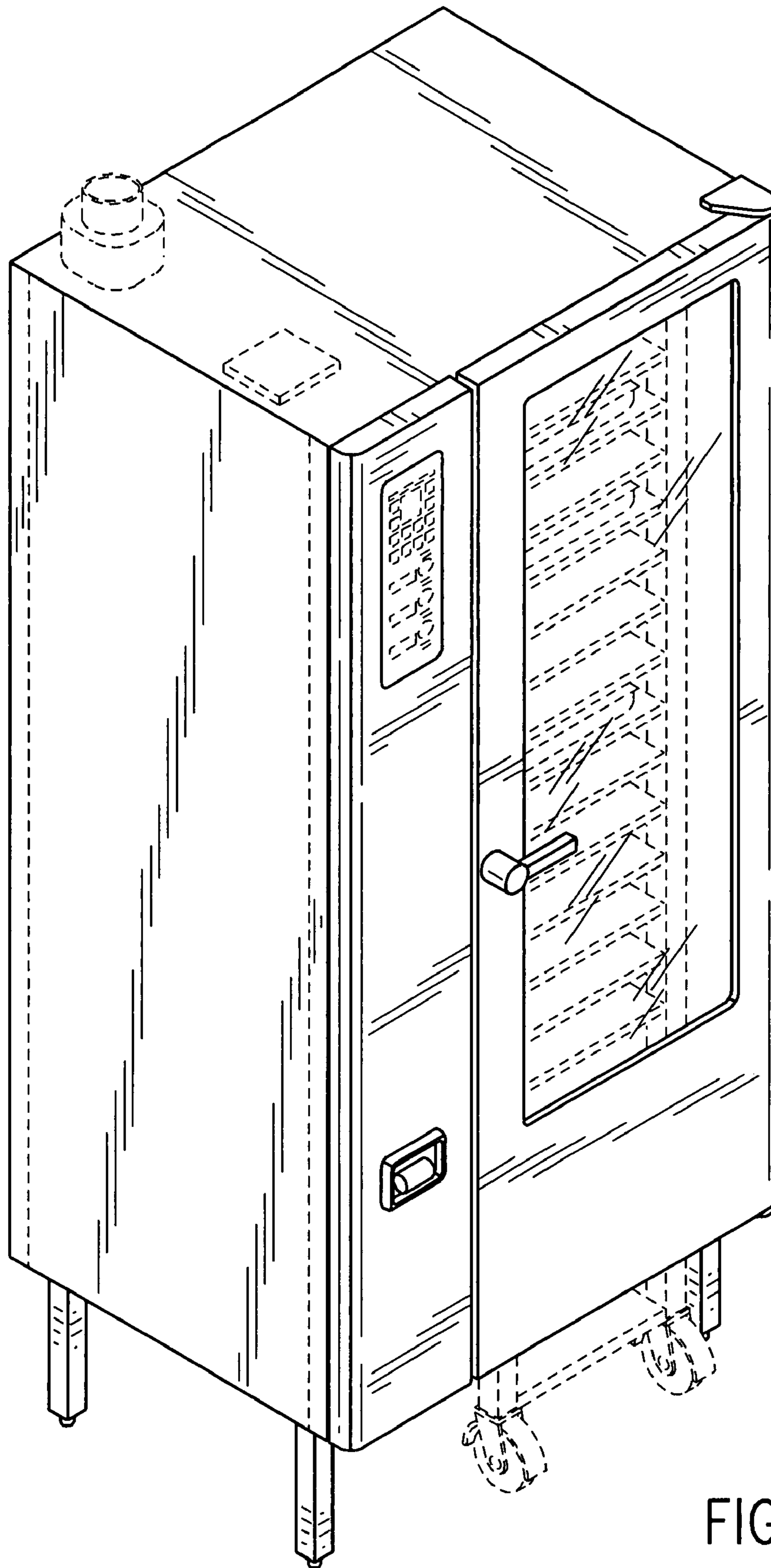

FIG. 15

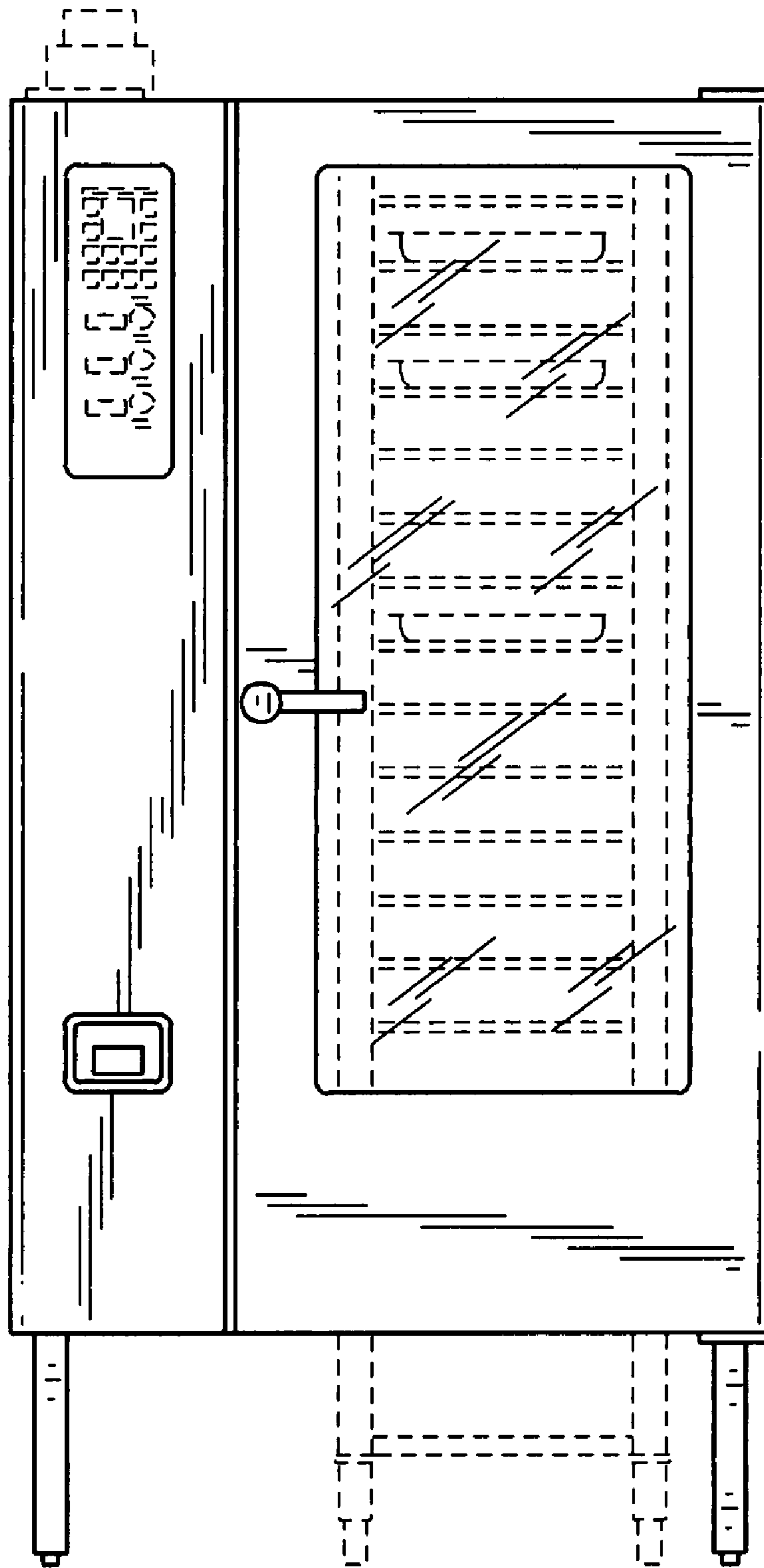

FIG. 16

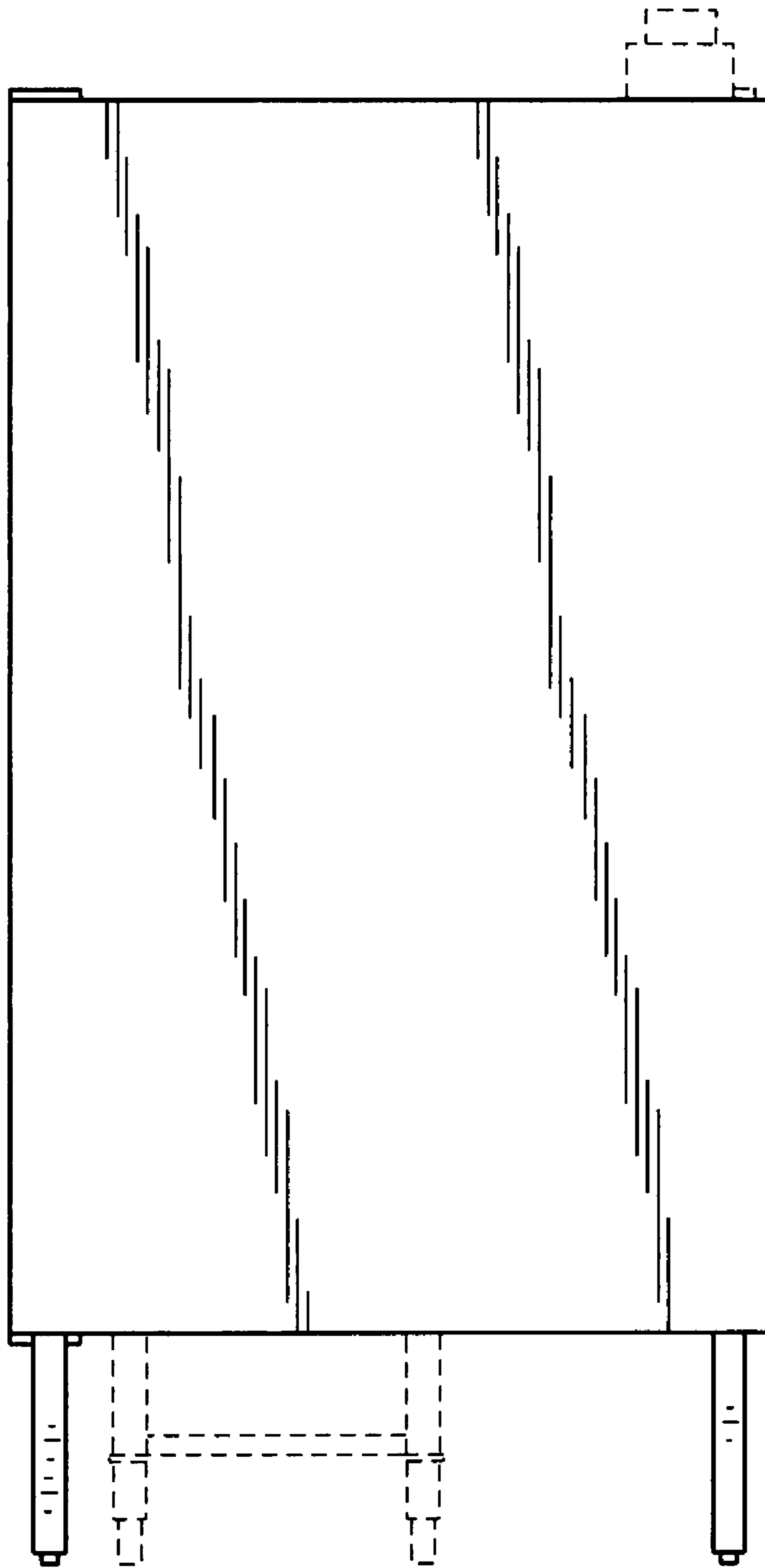

FIG. 17

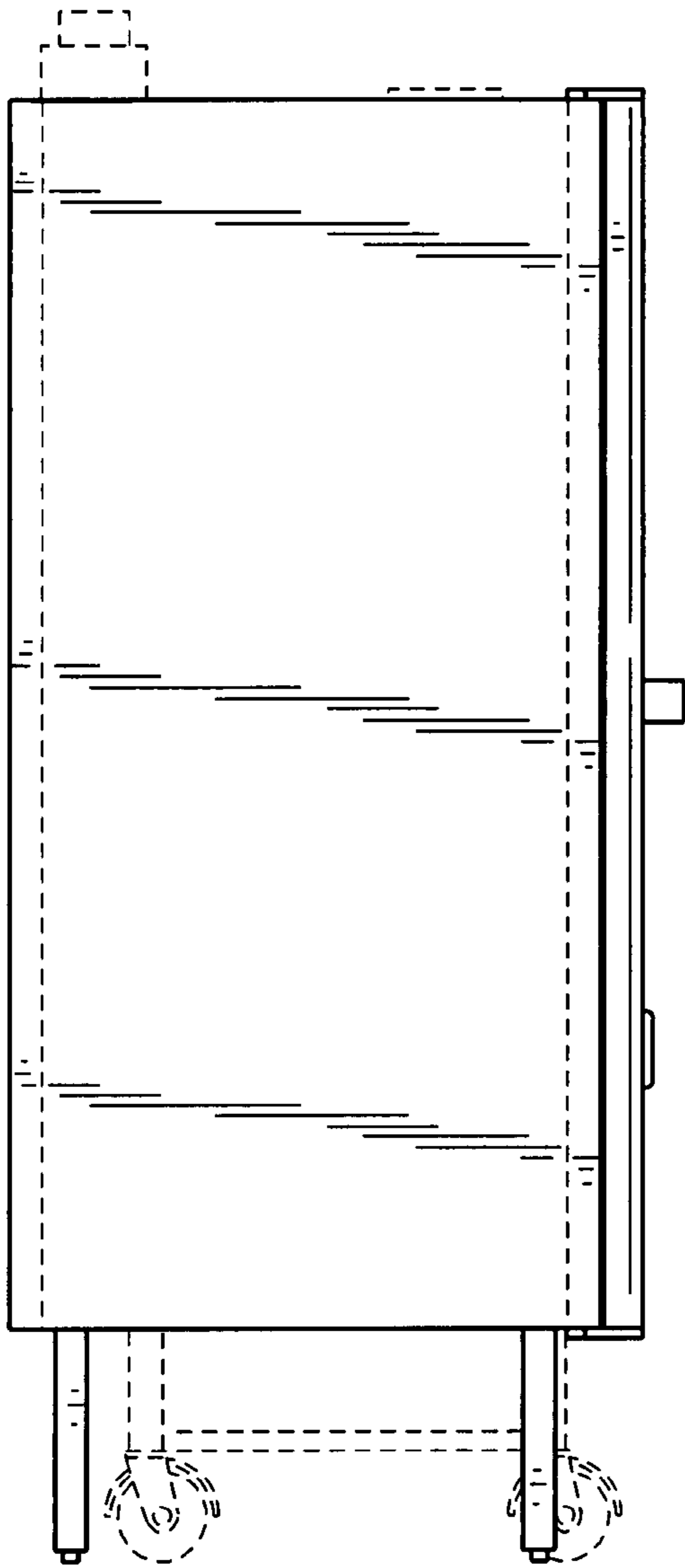

FIG. 18

FIG. 19

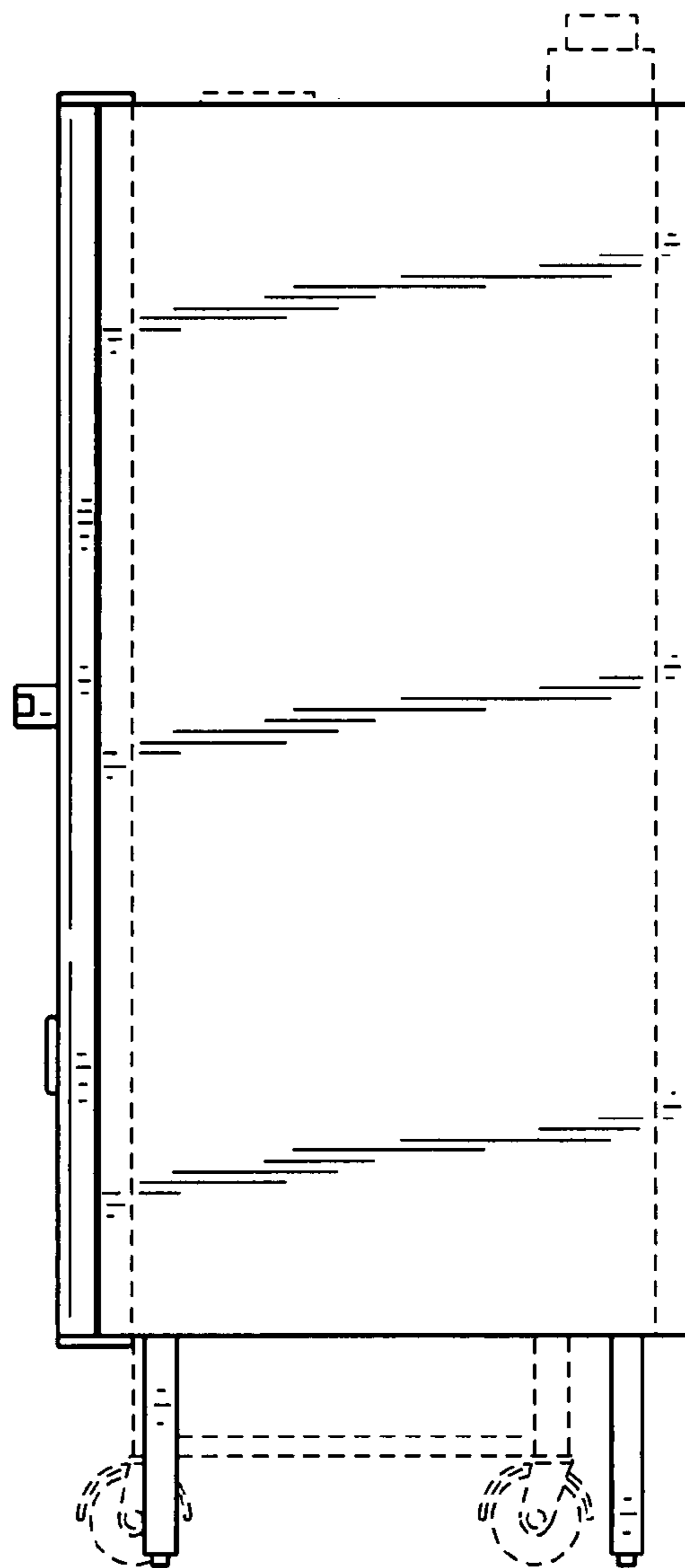

FIG. 20

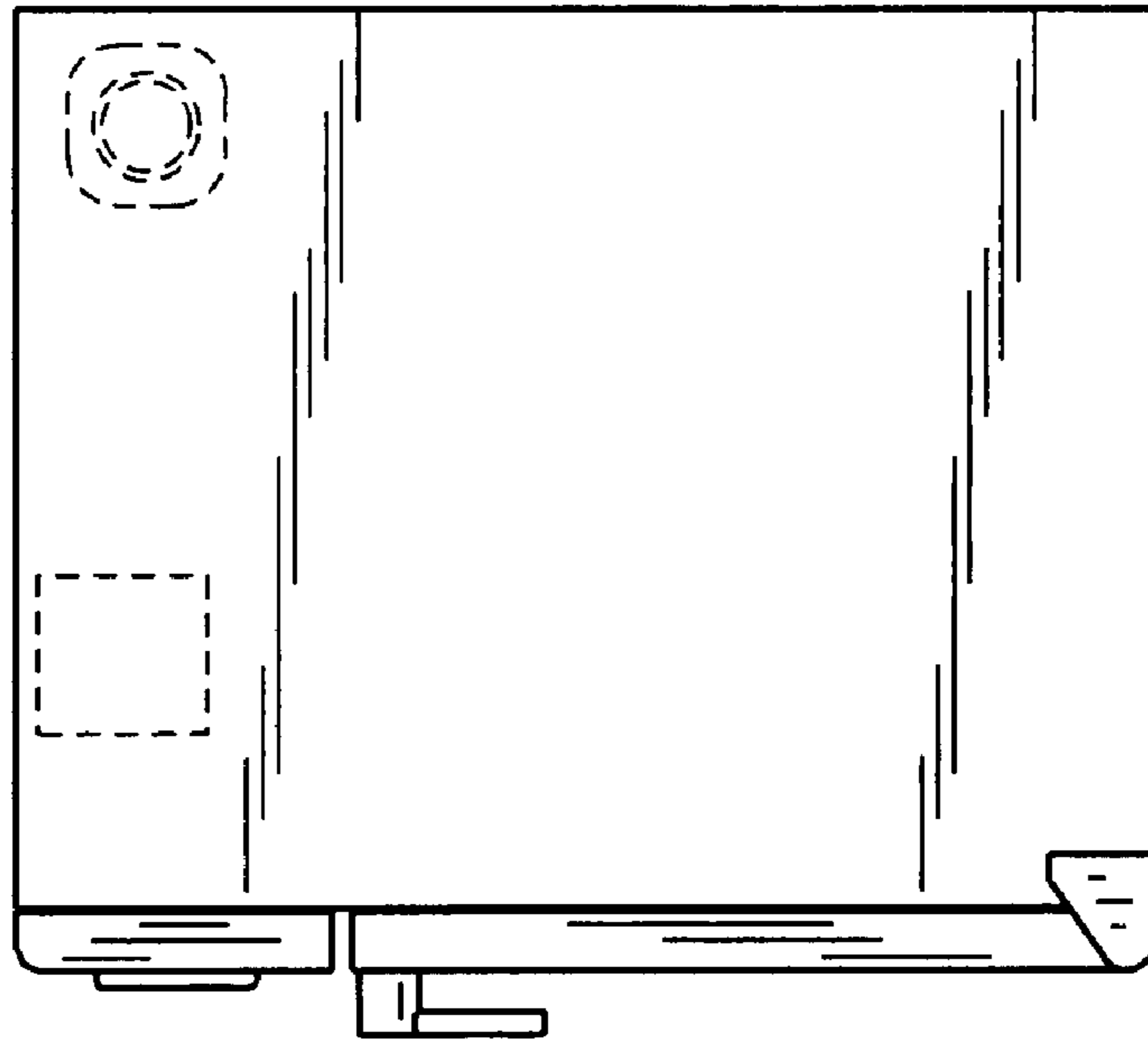

FIG. 21

