



US00D567501S

(12) **United States Design Patent**  
**Zusman**

(10) **Patent No.:** **US D567,501 S**

(45) **Date of Patent:** **\*\* Apr. 29, 2008**

(54) **HOLSTER FOR A GUN**

(76) Inventor: **Nisim Zusman**, Meshek #87, Moshav  
Ein Ayala, D.N. Chof Hacarmel 30825  
(IL)

(\*\*) Term: **14 Years**

(21) Appl. No.: **29/274,381**

(22) Filed: **Apr. 20, 2007**

(51) **LOC (8) Cl.** ..... **03-01**

(52) **U.S. Cl.** ..... **D3/222**

(58) **Field of Classification Search** ..... D3/222,  
D3/223; 224/191-193, 238, 243, 911-912,  
224/901.4, 666, 676, 668

See application file for complete search history.

(56) **References Cited**

U.S. PATENT DOCUMENTS

814,599 A	3/1906	Freyer	
837,156 A	11/1906	Townsend	
1,295,831 A	3/1919	Alderson	
2,347,006 A	4/1944	Tibbetts	224/2
2,408,678 A	10/1946	Paley	224/2
2,443,397 A	6/1948	Myers	224/2
2,765,968 A	10/1956	Gaylord	224/2
3,008,617 A	11/1961	Villwock	224/2
3,128,926 A	4/1964	Stella	224/2
3,707,250 A	12/1972	Esposito	224/2 B
3,731,858 A	5/1973	Baker	224/2 B
3,777,952 A	12/1973	Theodore	224/2 B
3,952,930 A	4/1976	Baldocchi	224/2 C
3,977,583 A	8/1976	Bianchi et al.	224/2 B
4,035,902 A	7/1977	Bianchi et al.	224/446
4,044,929 A	8/1977	Caruso	224/2 B
4,062,481 A	12/1977	Clark	224/2 B
4,065,039 A	12/1977	Bianchi et al.	224/2 B
4,084,734 A	4/1978	Bianchi et al.	224/2 B
4,101,060 A	7/1978	Bianchi et al.	224/2 B
4,143,798 A	3/1979	Perkins	224/243
4,205,768 A	6/1980	Hill et al.	224/193
4,218,000 A	8/1980	Mixson	224/911
4,258,871 A	3/1981	McMahon	224/192
4,270,680 A	6/1981	Bianchi	224/193

4,277,007 A *	7/1981	Bianchi et al.	224/193
4,286,741 A	9/1981	Rogers	224/193
4,542,841 A	9/1985	Bianchi et al.	224/193
4,577,787 A	3/1986	Hersey	224/243

(Continued)

FOREIGN PATENT DOCUMENTS

DE 26 39 248 3/1978

(Continued)

OTHER PUBLICATIONS

Springfield Armory, XD Point and Shoot Ergonomics, Jan. 2007, front cover, rear cover and pp. 1-34.

*Primary Examiner*—Catherine R. Oliver

(74) *Attorney, Agent, or Firm*—Morgan Lewis & Bockius LLP

(57) **CLAIM**

The ornamental design for a holster for a gun, as shown and described.

**DESCRIPTION**

FIG. 1 is a perspective view of a holster for a gun in accordance with my new design;

FIG. 2 is a another perspective view thereof;

FIG. 3 is a front view thereof;

FIG. 4 is a top view thereof

FIG. 5 is a rear view thereof;

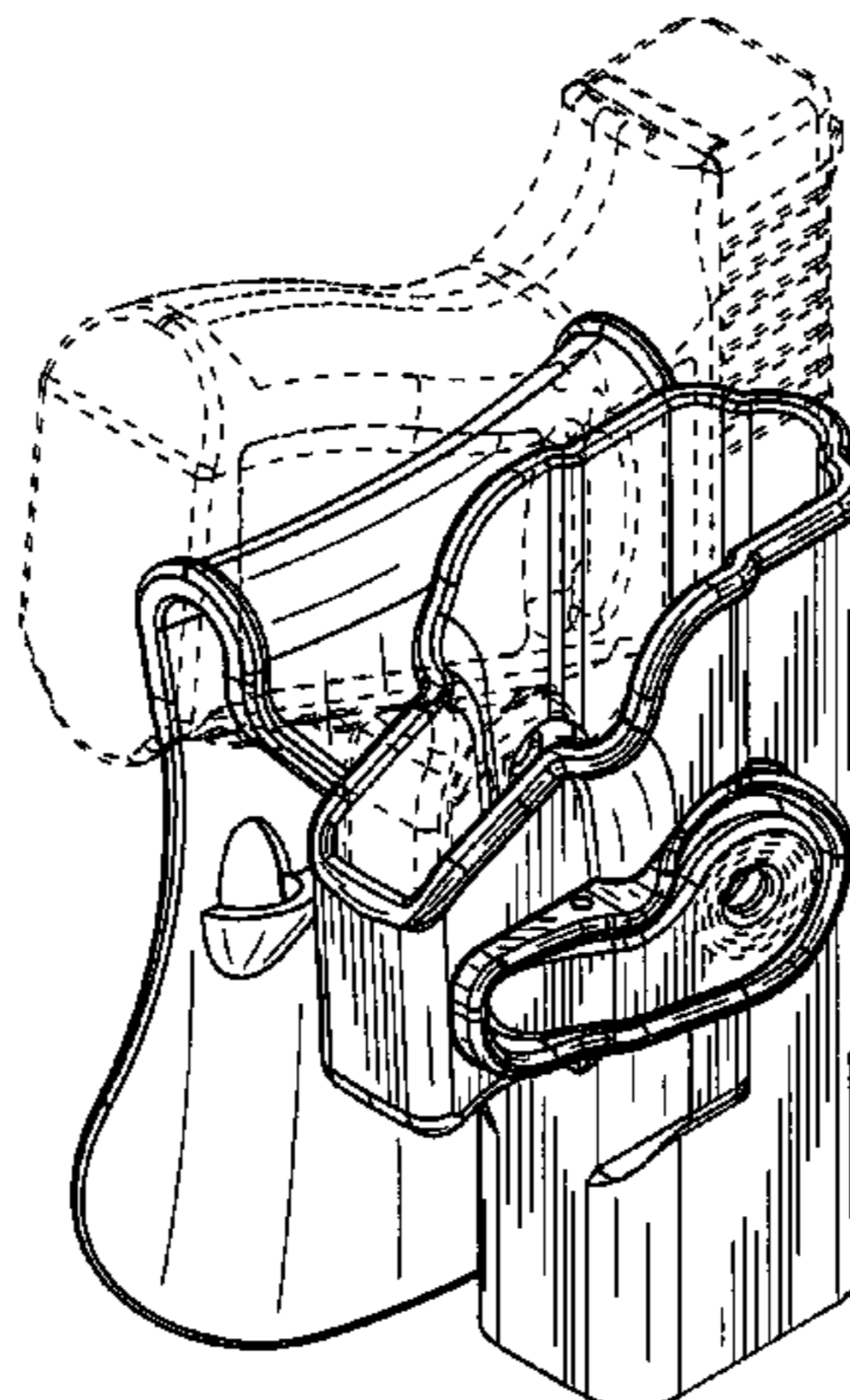
FIG. 6 is a bottom view thereof.

FIG. 7 is a right side view thereof; and,

FIG. 8 is left side view thereof.

The broken lines immediately adjacent the shaded areas represent the bounds of the claim, and all other broken lines are for illustrative purposes only. None of the broken lines form a part of the claimed design.

**1 Claim, 4 Drawing Sheets**



# US D567,501 S

Page 2

## U.S. PATENT DOCUMENTS

4,662,552 A	5/1987	Uyehara .....	224/251
4,741,465 A	5/1988	Johnson .....	224/230
4,886,197 A	12/1989	Bowles et al. ....	224/243
4,925,075 A	5/1990	Rogers .....	224/244
4,953,769 A	9/1990	Parsons et al. ....	224/247
D311,277 S	10/1990	Cupp .....	D3/101
4,966,321 A	10/1990	Outlaw .....	224/253
5,018,653 A	5/1991	Shoemaker .....	224/198
5,054,670 A	10/1991	Gallagher .....	224/191
5,100,036 A	3/1992	Rogers et al. ....	224/244
D327,367 S	6/1992	Carrow et al. ....	D3/101
D331,497 S	12/1992	Dixon .....	D3/101
5,209,383 A	5/1993	Theodore .....	224/193
5,251,798 A	10/1993	Theodore .....	224/193
5,251,799 A	10/1993	Theodore .....	224/206
5,265,781 A	11/1993	Nichols .....	224/198
5,275,317 A *	1/1994	Rogers et al. ....	224/244
5,282,559 A	2/1994	Wisser et al. ....	224/243
5,419,472 A	5/1995	Hellweg et al. ....	224/198
5,421,497 A	6/1995	Gilmore .....	224/198
5,544,794 A	8/1996	Nichols .....	224/667
D373,242 S	9/1996	Beletsky .....	D3/222
5,551,610 A	9/1996	Clifton, Jr. ....	224/197
5,570,830 A	11/1996	Nichols .....	224/676
5,632,426 A	5/1997	Beletsky et al. ....	224/243
D392,458 S *	3/1998	Batts .....	D3/222
5,865,357 A	2/1999	Goodwin .....	224/587
5,875,944 A	3/1999	Beletsky .....	224/198
5,918,784 A	7/1999	Serpa .....	224/244

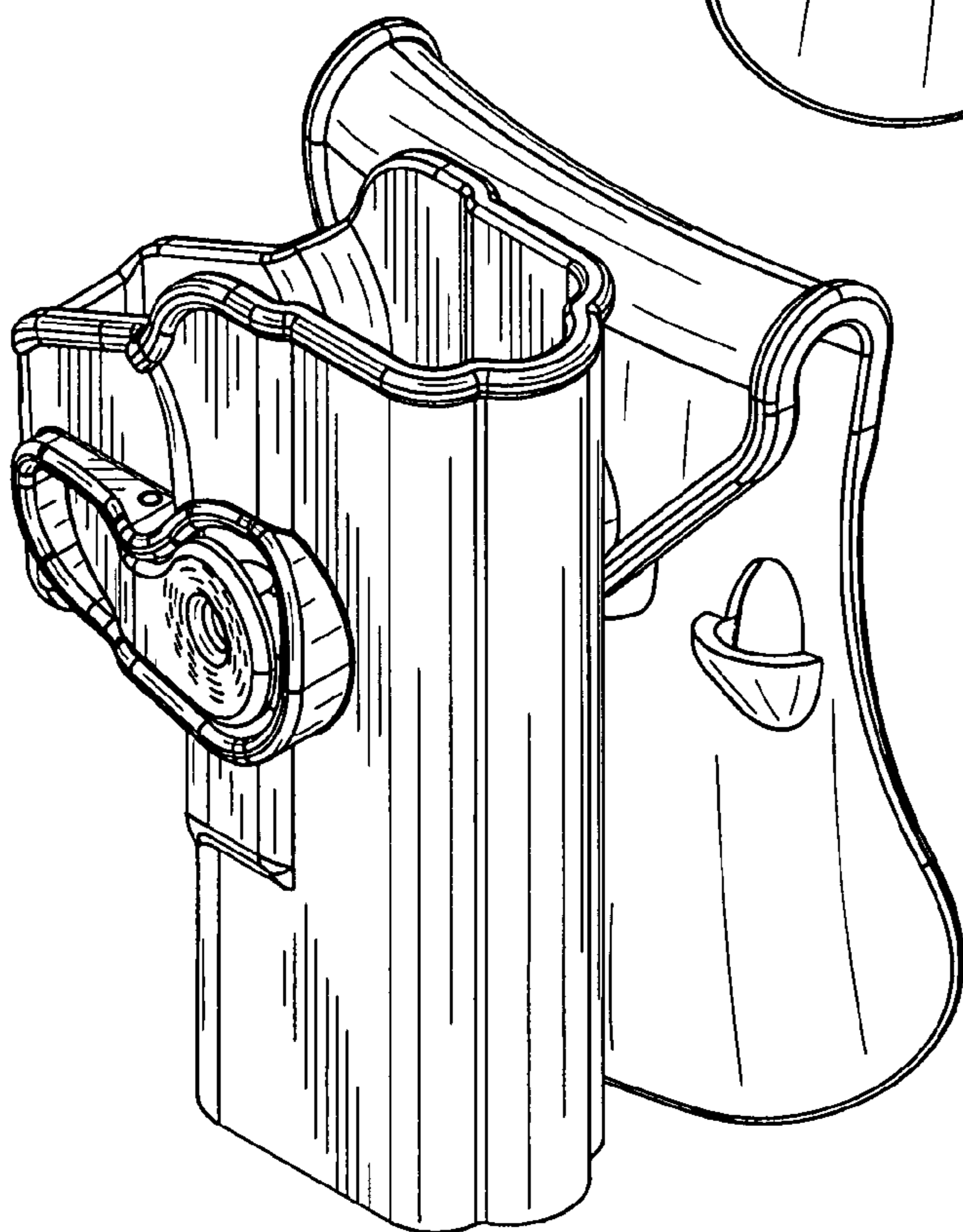
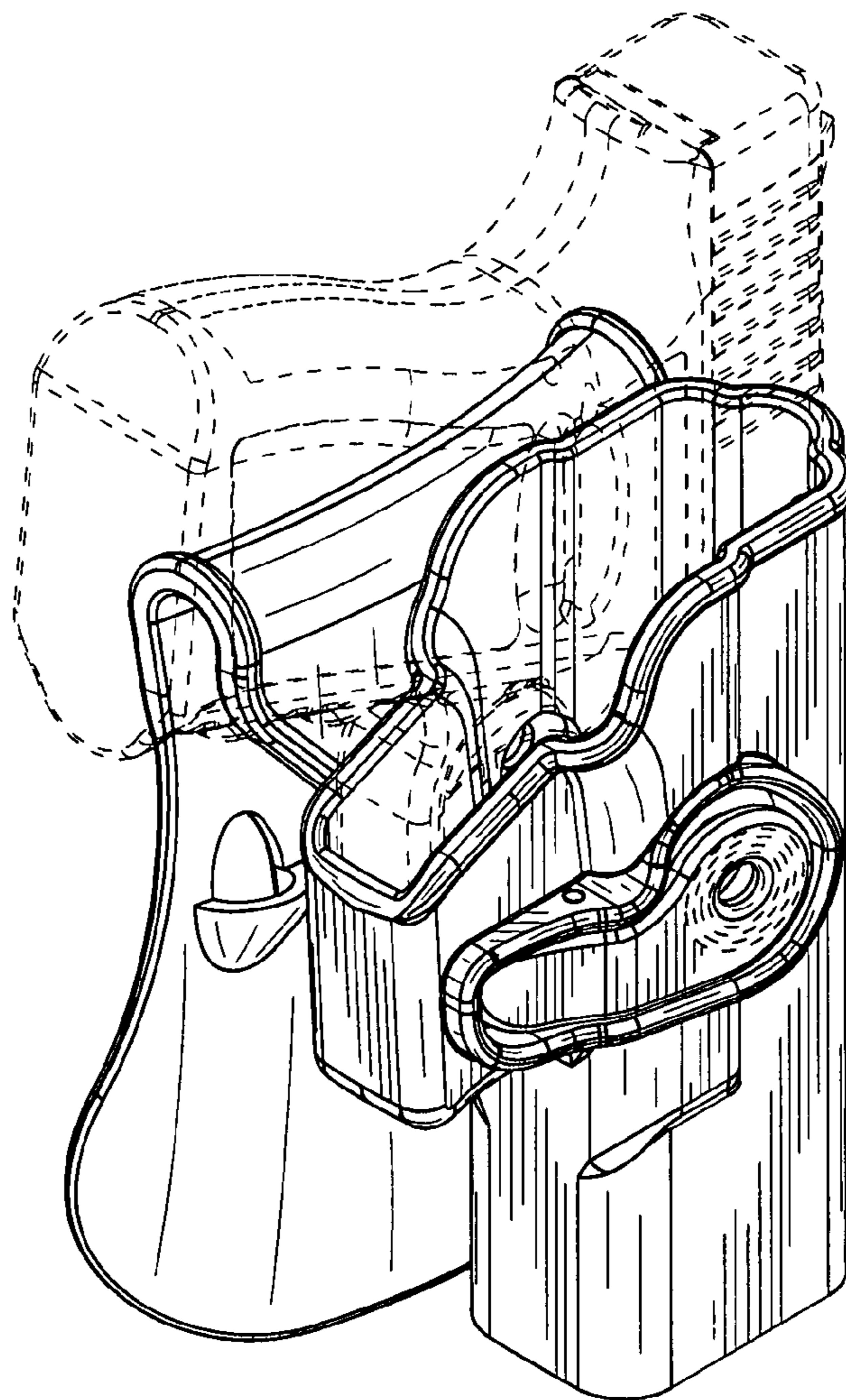
5,996,865 A	12/1999	Bissey .....	224/275
6,154,997 A	12/2000	Aluotto et al. ....	42/90
6,398,089 B1	6/2002	Har-Shen .....	224/192
6,763,984 B2	7/2004	Gallagher .....	224/193
6,769,581 B2	8/2004	Rogers et al. ....	224/243
D501,991 S	2/2005	Cook et al. ....	D3/222
D507,104 S	7/2005	Gregory et al. ....	D3/222
D508,318 S	8/2005	Gregory et al. ....	D3/222
6,948,644 B1	9/2005	Beletsky .....	224/193
D512,561 S	12/2005	Cook et al. ....	D3/222
7,028,426 B1	4/2006	Viani .....	42/70.07
7,032,342 B2	4/2006	Pikielny .....	42/146
7,117,625 B2	10/2006	Pikielny .....	42/90
D537,624 S *	3/2007	Har-shen .....	D3/222
7,191,556 B2	3/2007	Pikielny .....	42/7
D543,354 S *	5/2007	Carver et al. ....	D3/222
7,216,450 B2	5/2007	Pikielny .....	42/71.01
7,258,259 B1	8/2007	Owens .....	224/193
2005/0223614 A1	10/2005	Pikielny .....	42/50
2005/0268518 A1	12/2005	Pikielny .....	42/90
2005/0268519 A1	12/2005	Pikielny .....	42/124
2006/0130386 A1	6/2006	Pikielny .....	42/85
2006/0236583 A1	10/2006	Pikielny .....	42/85
2007/0017140 A1	1/2007	Pikielny .....	42/87
2007/0084101 A1	4/2007	Pikielny .....	42/71.01
2007/0175935 A1 *	8/2007	Clifton, Jr. ....	224/243

## FOREIGN PATENT DOCUMENTS

GB                    2 256 700                    12/1992

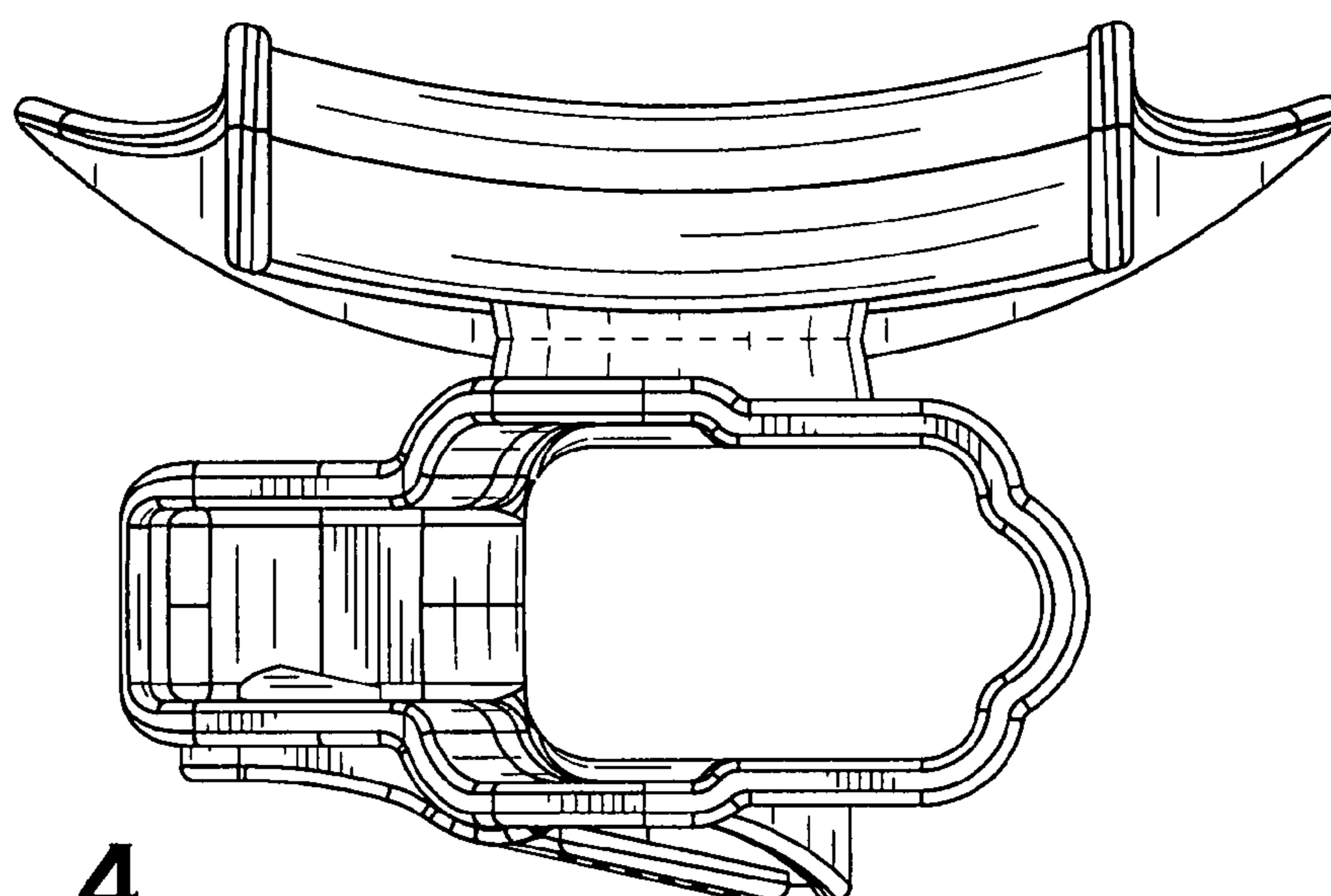
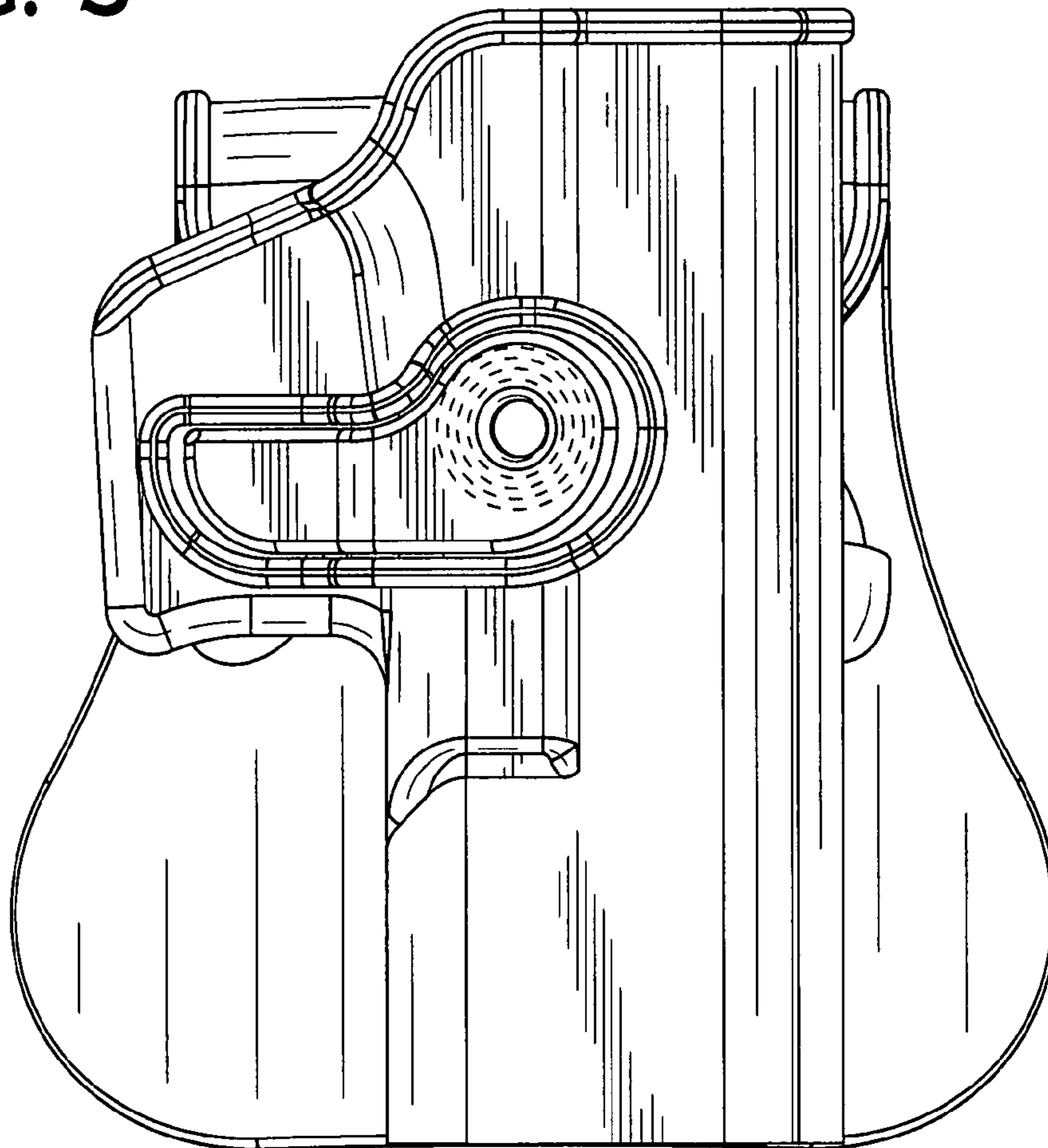
\* cited by examiner

**FIG. 1**



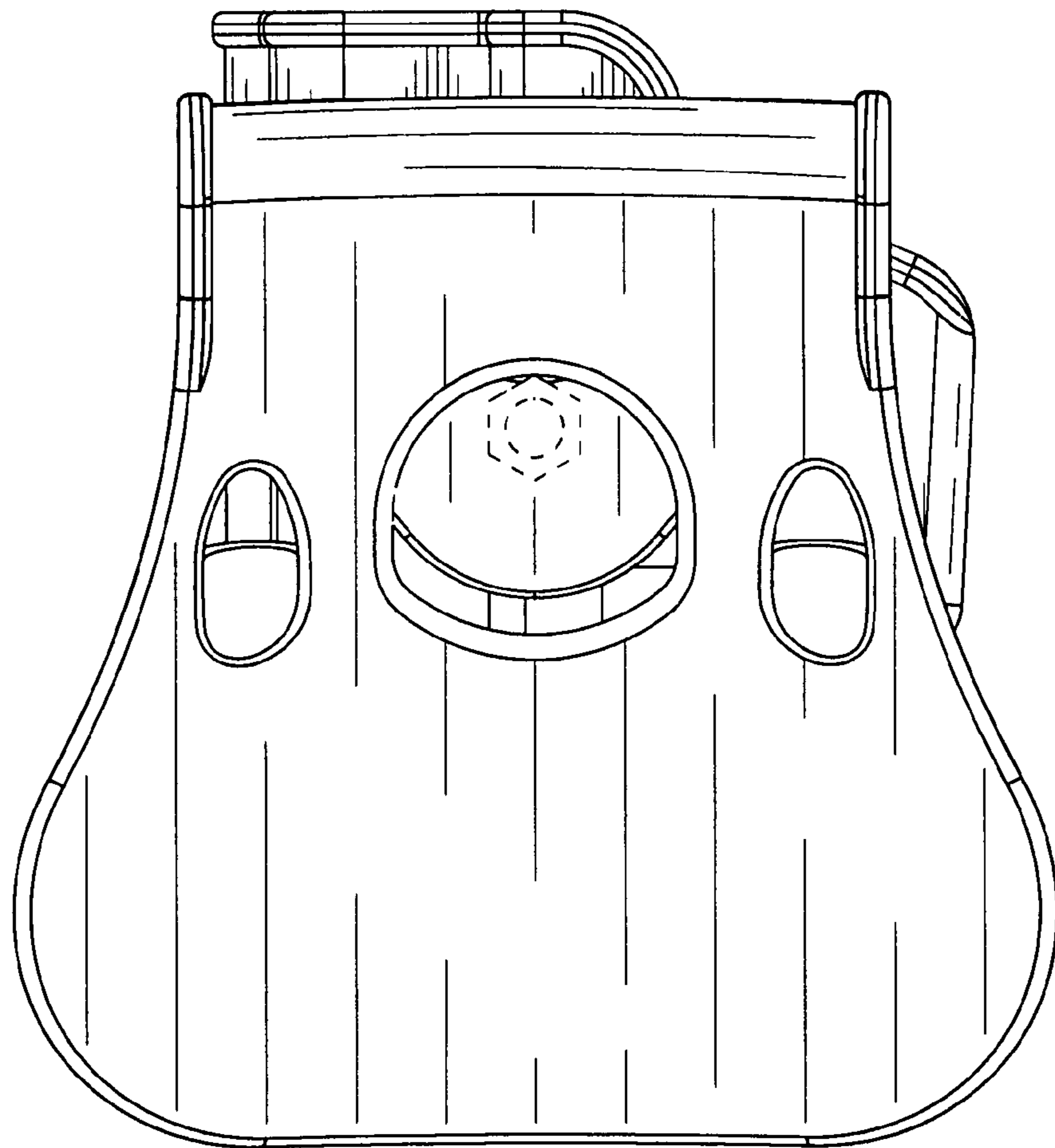
**FIG. 2**

**FIG. 3**

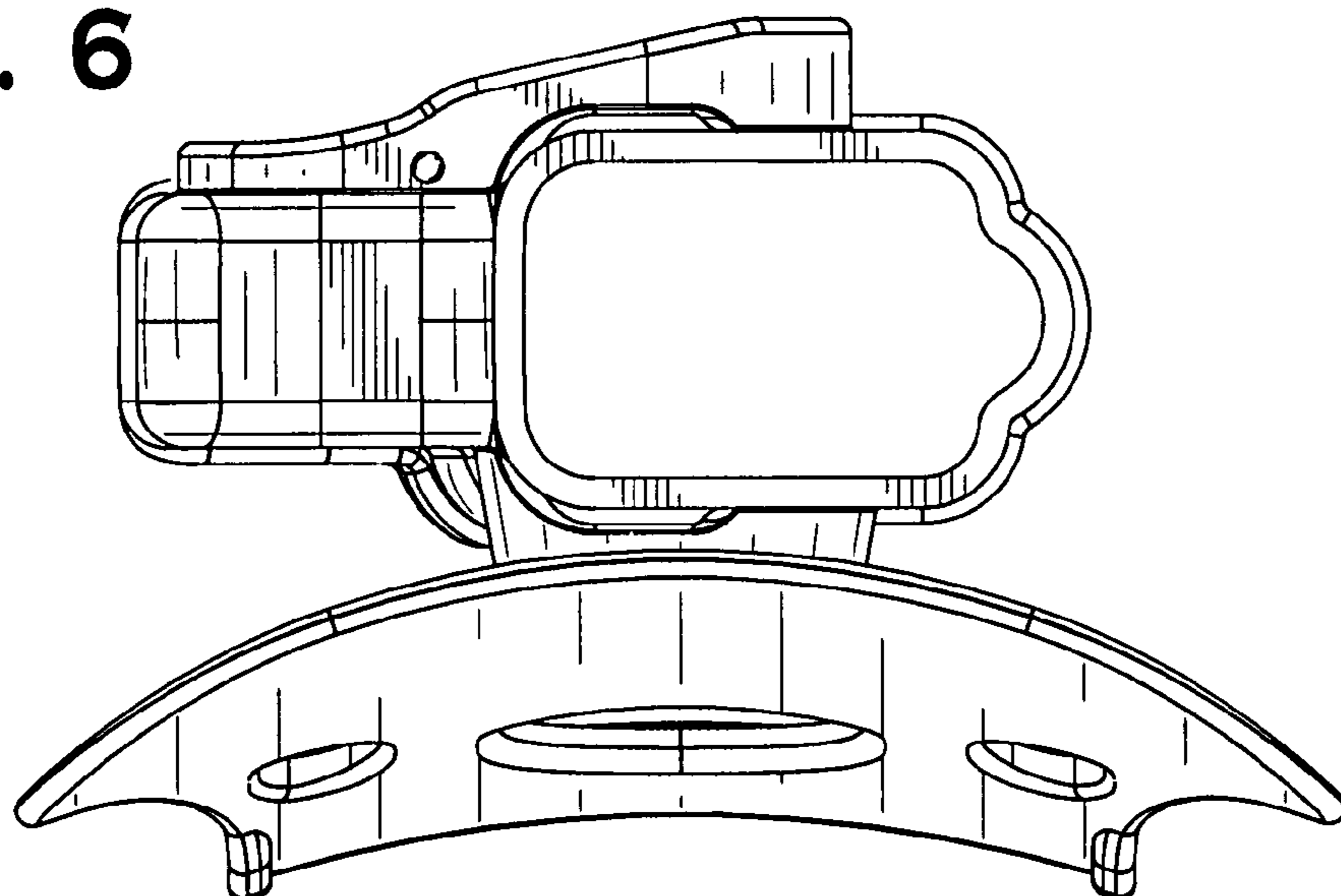


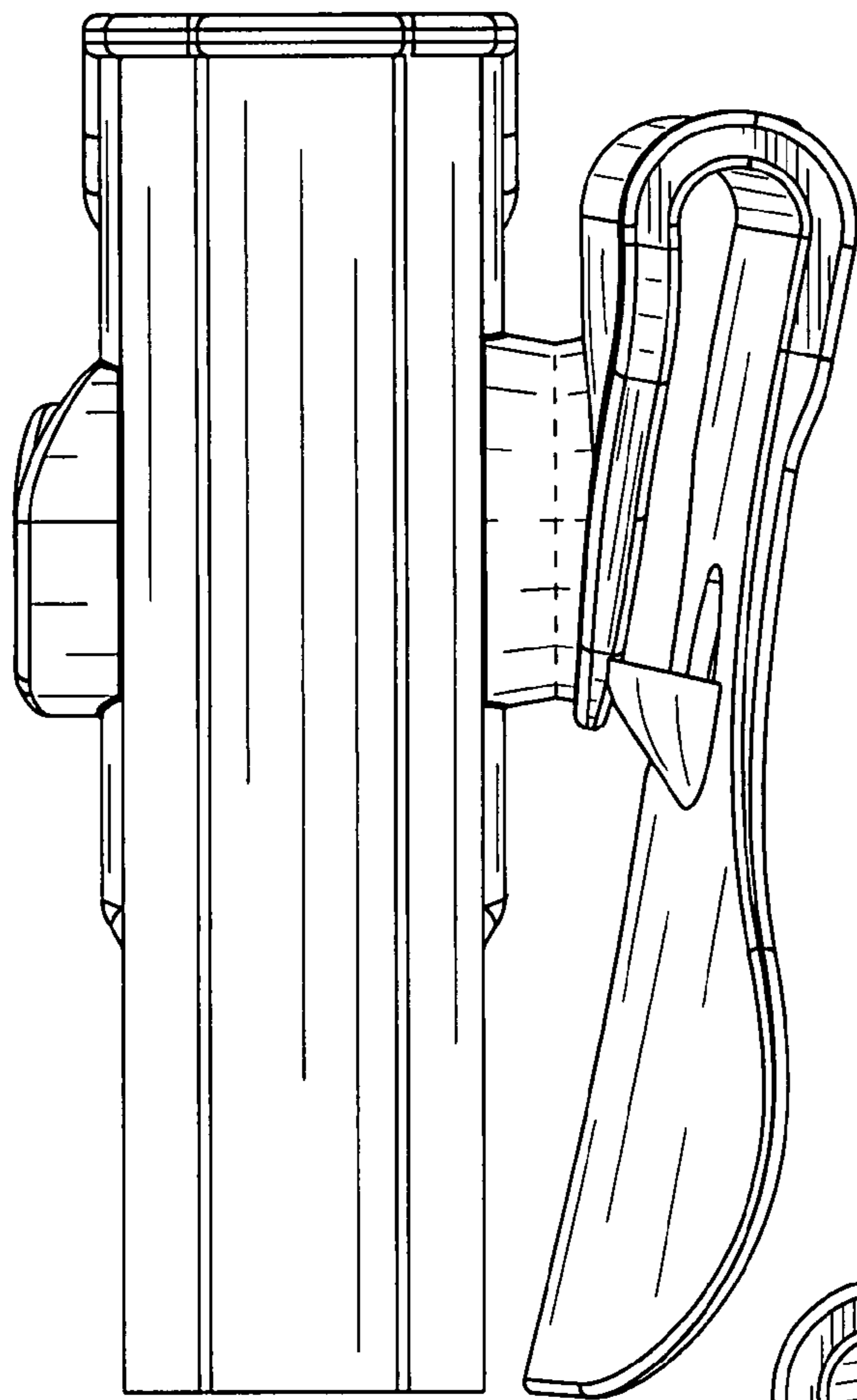
**FIG. 4**

**FIG. 5**

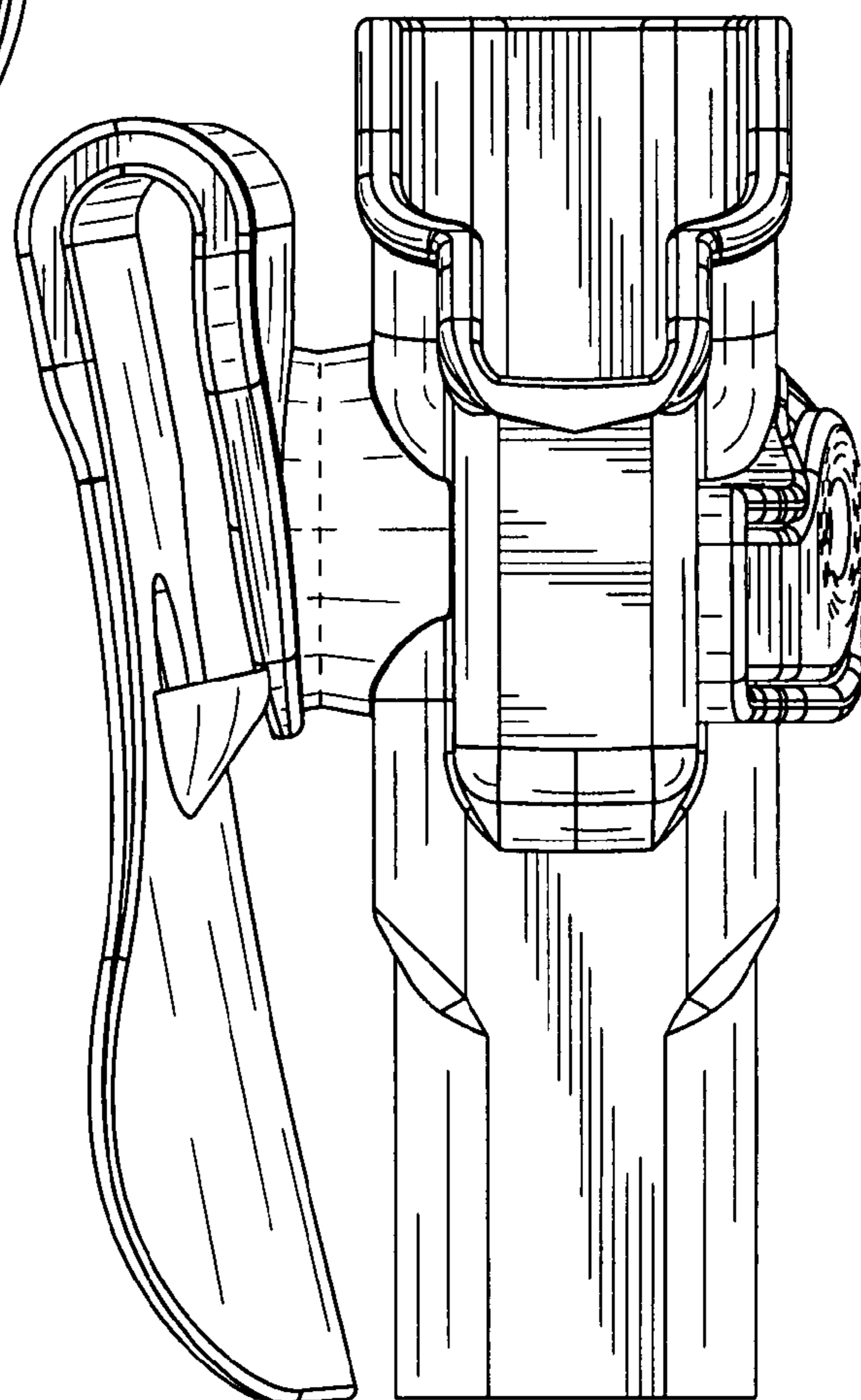


**FIG. 6**





**FIG. 7**



**FIG. 8**